



Get Organised™

PRODUCT CATALOGUE

2026



WELCOME TO OUR WORLD

When you choose TengTools you immediately stand out from the crowd as a professional who is intent on achieving their goals.



















TengTools offer a modular tool system that is built to last. Build your ultimate tool kit with our large selection of storage and tool sets enabling customised tool solutions for any kind of industry or profession.

Get Organised™ with a tool control system designed to boost efficiency and save time.



CONTENTS

TT Series	22
Tool Kits	22
Tool Control System	50
FOAM Series	104
Tool Kits	104
Tool Control System	128
Other Tool Sets	174
Tool Storage	182
Socket Sets	220
Sockets & Accessories	250
Torque Tools	298
Spanners & Wrenches	312
Screwdrivers	334
Bits & Drivers	348
Hex & Tx Keys	378
Pliers	398
Insulated Tools	418
Cutting Tools	430
Measuring Tools	448
Auto Tools	458
Service Tools	470
Air Tools	498
Index	508

Tool Kits	
Tool Control System	
Other Tool Sets	
Tool Storage	
Socket Sets	
Sockets & Accessories	
Torque Tools	
Spanners & Wrenches	
Screwdrivers	
Bits & Drivers	
Hex & Tx Keys	
Pliers	
Insulated Tools	
Cutting Tools	
Measuring Tools	
Auto Tools	
Service Tools	
Air Tools	

EXPERT SOLUTIONS FOR INDUSTRIAL EFFICIENCY

- ▶ REDUCE COSTS
- ▶ SAVE TIME
- ▶ IMPROVE SAFETY

Why TengTools?

- **Expert Industrial Solution Provider** – More than just tools; we deliver solutions for tool control and organisation.
- **Proven Cost Reduction & Efficiency Gains** – Our *Get Organised™* system cuts downtime, improves productivity, and enhances workplace safety.
- **Dedicated Sales & User Support** – We work alongside businesses to design tailored tool control solutions that match their exact needs.

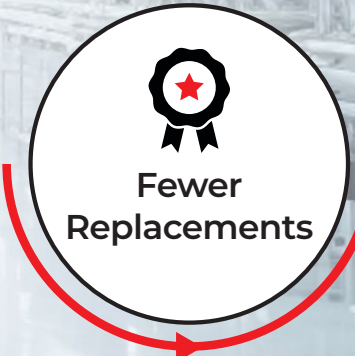

Get Organised™

DESIGNED IN SWEDEN

**QUALITY PRODUCTS THAT COMBINE
SWEDISH DESIGN AND ENGINEERING WITH
A STRONG ENVIRONMENTAL AWARENESS.**

At TengTools, our products reflect the precision, durability, and reliability that Swedish engineering is known for. Designed with a focus on quality and sustainability.

We prioritise functionality, ergonomic design, and long-lasting performance—ensuring that each tool not only meets, but exceeds, the demands of professionals worldwide.

With a focus on sustainability, when you Get Organised™ with TengTools, you minimize the need to replace tools. That is sustainability in a nutshell.





STREAMLINE YOUR WORKFLOW

TAILOR YOUR TOOL SOLUTION TO YOUR NEEDS

TengTools offer a modular tool system that is built to last.

Build your ultimate tool kit with our large selection of storage and tool sets enabling customised tool solutions for any kind of industry or profession.

Don't waste space and money on tools you don't need. Buy the exact tools you require and if you need more in the future, just add new sets that fit seamlessly into your storage solution.

When you purchase TengTools you are guaranteed the highest quality. If a tool is worn out or if you happen to lose a piece, individual tools can be easily purchased as replacements.



LIFETIME GUARANTEE

QUALITY IS EVERYTHING

All our tools meet – or exceed – the demands in ISO, DIN and other international standards. As an extra security for you, our tools are offered with a guarantee against material and manufacturing defects during the normal lifetime of the product in question. Defective products covered by the guarantee will be repaired or replaced.

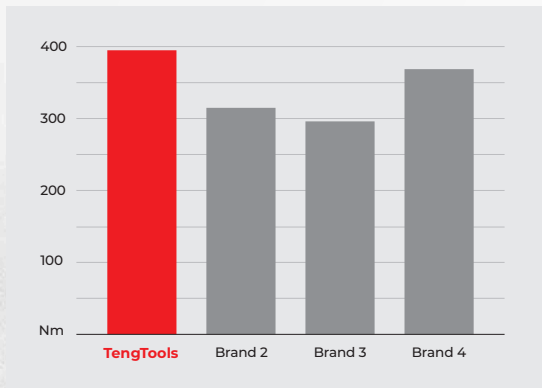

Adjustable wrench Comparison test. May 14, 2020. Torque breaking point (Nm). ISO 6787:2018.

Proven to be better.

Independent tests have shown that our tools not only exceed the international quality standards – they are best in class. TengTools was positioned first or second in all of the eight product categories tested.



* Defects or performance issues caused by accidents, not approved modifications, misuse, normal wear & tear or lack of proper care are excluded.
A guarantee claim requires the submission or shipment of the complete product to the retailer or distributor along with a receipt or invoice validating the purchase date and the product designation.
Returned products are first managed by the distributor network, entrusted with applying TengTools' warranty and replacing items on stock. Replacement or repair of the product will be carried out as quickly as possible.



FOR A BETTER WORKFLOW

BENEFITS OF A WELL-ORGANISED HAND TOOL SOLUTION:



Time Saving: An organised tool storage system can help you save time by reducing the time you spend searching for tools. When you have a designated spot for every tool, you can quickly locate the one you need.



Increased productivity: An organised workspace can help you work more efficiently and effectively. When you have a clear idea of where each tool is located, you can work faster, and the time you save can be used to complete more tasks.



Improved safety: A disorganised tool storage system can lead to accidents, such as tripping or falling, and injuries caused by misplaced tools. An organised system, on the other hand, reduces the chances of accidents and ensures that each tool is in its designated place, making it less likely to be left lying around where it could cause harm.



Cost-effective: An organised tool storage system can help you avoid buying tools you already have or replacing lost ones, saving you money in the long run.



Better tool longevity: When tools are stored properly, they are less likely to suffer damage from being knocked around or exposed to moisture or extreme temperatures. This means that they will last longer and perform better.



Sustainability: When you Get Organised™ with our long-lasting tools, you minimize the need to purchase replacements. That is sustainability in a nutshell.

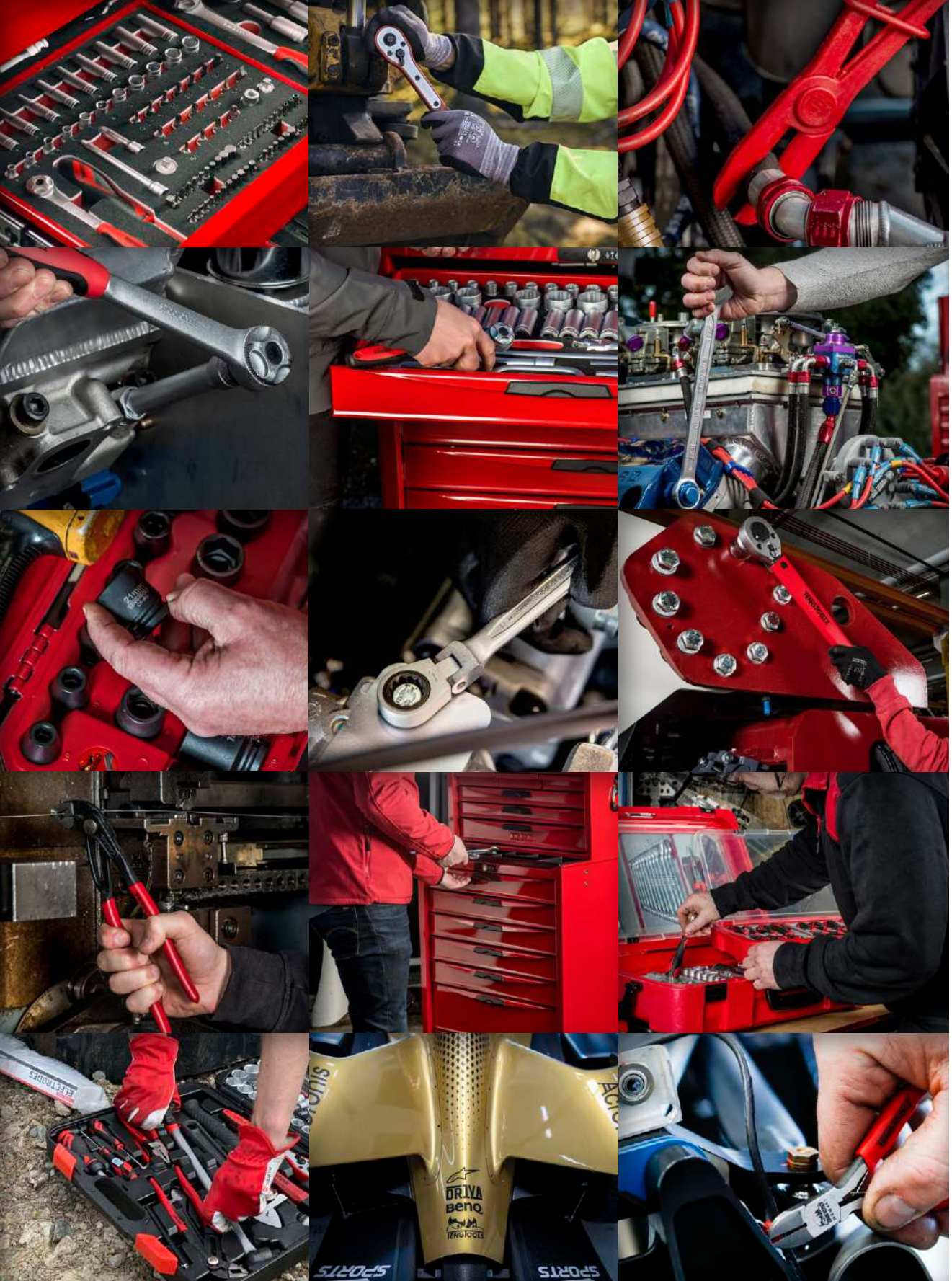

BESPOKE FOAM KITS

BENEFITS OF A WELL-ORGANISED HAND TOOL SOLUTION:



- **Custom layouts** designed around your tools and workflow
- Maintains **TengTools quality**, fit, and finish
- **Flexible solutions** for standard and specialist equipment
- **Clear tool visibility** for fast checks and control
- **Reduced tool loss** and improved accountability
- **Consistent layouts** across teams and locations
- Supports **organised and controlled** working environments
- Compatible with **Smart Access and RFID** tool control

Scan the QR code
to contact us or
request a call back







Scan the QR code
to contact us or
request a call back





Scan the QR code
to contact us or
request a call back









Get Organised™



TT SERIES TOOL KITS

BETTER TOOLS BRING BETTER RESULTS

Each tool kit has been compiled with the help of technicians from various trades and are available in many shapes and sizes. From full stacks to roller cabinets, and top boxes to portable solutions, there is a kit to fit your exact needs

TT SERIES



Space-saving: The TT Series allows you to fit more tools in each drawer.



Durability: TT Series tool trays are made from a durable recyclable plastic that can withstand heavy use and are resistant to wear and tear.



Easy to clean: TT Series tool trays can be easily wiped clean with a damp cloth, making them simple to maintain and keep clean.



Lightweight: TT Series tool trays are lightweight, making the toolkit easier to move around and transport as required.



Corrosion-resistant: TT Series tool trays are resistant to corrosion, making them ideal for use in humid or damp environments.



PRO35™

MONSTER™

53" PRO35™ MONSTER STACK TOOL KIT 1295 PIECES RED

1295
PIECES

TT
SERIES



- 19 Drawer
- 3-Piece Cabinet Frame
- Heavy Gauge Steel
- 5-Step Phosphate-Free Rust Protection
- 53" Wide Cabinet
- 6" x 2" Castor Wheels with Brakes
- 3 Step Ball Bearing Slides
- Comfort Grip Handle
- Combination Lock

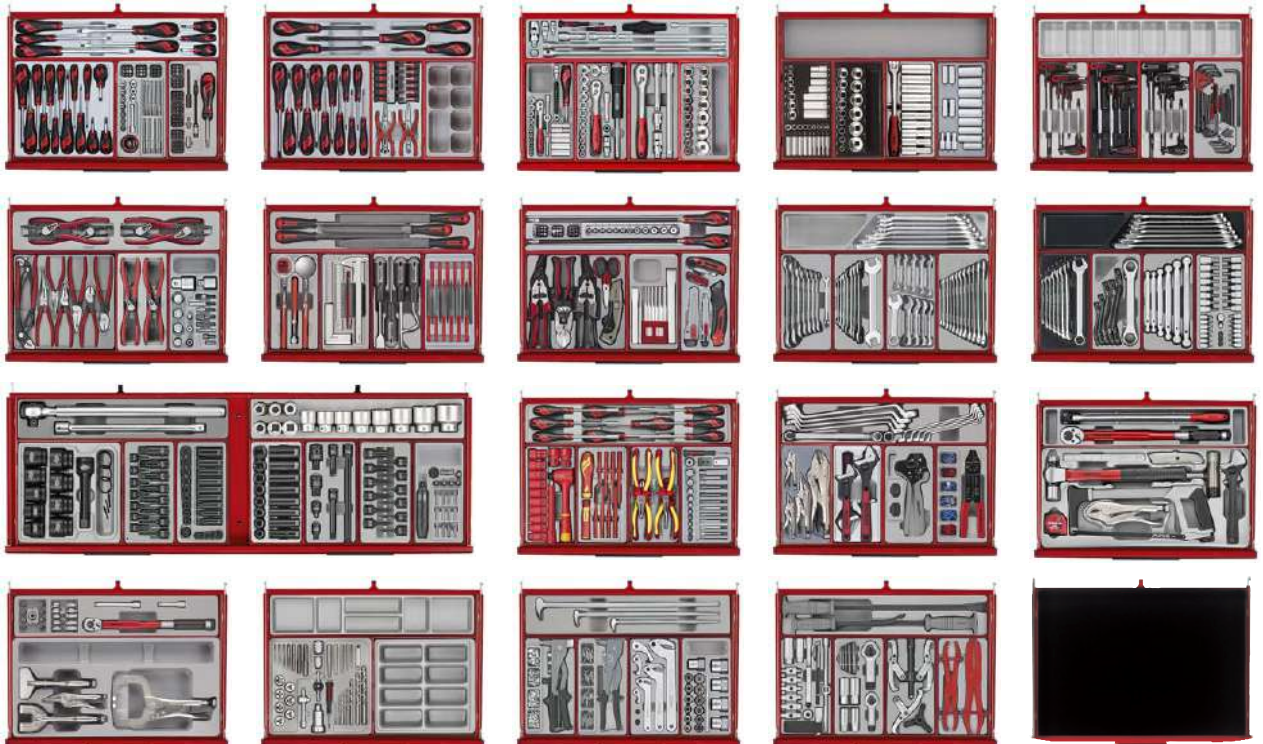

Icon	Icon	
		TSW53R9 53" PRO35™ roller cabinet 9 drawers red
		TST53R10F 53" PRO35™ tool chest 10 drawers red
		TCF07 Fixing brackets for 26", 37" & 53" deep tool chest
		580T Side shelf for roller cabinet 457 x 100 x 50mm
1/10	TTD914N	Screwdriver Set Mixed TT2
1/10	TT1448	1/4" Socket & Bits Set TT1
1/10	TTMD74	Ratcheting Screwdriver Bit Set TT1
1/10	TTX918N	Screwdriver Set Flat & PH TTX4
2/10	TTD912TXN	Screwdriver Set TX TT2
2/10	TTM116	Mini Pliers & Screwdriver Set TT1
2/10	TT01	Storage Tray TT1 7 Compartments
2/10	TTXMDTN	Power Through Screwdriver Set TTX4
3/10	TT1435	1/4" Socket Set 6 pt TT1
3/10	TT3819	3/8" Socket Set 6 pt TT1
3/10	TT1205	1/2" Ratchet & Accessories Set TT1
3/10	TT1217	1/2" Socket Set 12 pt TT1
3/10	TTXEXT13	Extension Bars Set TTX4
4/10	TTAF32	1/4" & 3/8" Socket Set AF 6 pt TT1
4/10	TT1215AF	1/2" Socket Set 12 pt AF TT1
4/10	TT1211	1/2" Deep Socket Set 12 pt TT1
4/10	TT3816	3/8" Socket Set 6 pt TT1
4/10	TTX00	Storage Tray TTX4 1 Compartment
5/10	TTHEX7	T-Handle Ball Point Hex Key Set TT1
5/10	TTHEX7AF	T-Handle Ball Point Hex Key Set AF TT1
5/10	TTTX7	T-Handle TX/TPX Key Set TT1
5/10	TTHT28	Ball Point Hex & TX Key Set TT1
5/10	TTX03	Storage Tray TTX4 8 Compartments
6/10	TTD441Q	Plier Set Vinyl Grip Q TT2
6/10	TT474-7E	Circlip Plier Set PRO 19-60 mm TT1
6/10	TTADP17	Socket Adaptor Set TT1
6/10	TTX474-9E	Circlip Plier Set PRO 40-100 mm TTX4
7/10	TTM03	Inspection Set TT1
7/10	TTBM	Measuring Tool Set TT1
7/10	TTSR04	Scraper Set TT1
7/10	TTNF12	Needle File Set TT1
7/10	TTXF05	Hand File Set TTX4
8/10	TTDCT05	Cutting Tool Set TT2
8/10	TTPC09	Punsch & Chisel Set TT1
8/10	TTK40	Knife Set TT1
8/10	TTXMD41N	Socket & Bit Set Flexible Handle TTX4
9/10	TT6508R	Ratcheting Combination Spanner Set R TT1
9/10	TT6208	Double Open Ended Spanner Set TT1
9/10	TT6010M	Stubby Combination Spanner Set TT1
9/10	TT1236	Combination Spanner Set TT1
9/10	TTX2032	Combination Spanner Set TTX4
10/10	TT3592	Combination Spanner Set AF TT1

Icon	Icon	
10/10	TTRORS	Ratcheting Ring Spanner Set TT1
10/10	TT6506	Double Flex Wrench Set TT1
10/10	TTBS35	1/4" & 3/8" Bit Socket Set TT1
10/10	TTX2640	Combination Spanner Set AF TTX4
1/9	TTD9416	3/4 Impact Socket Set DIN TT2
1/9	TT9015HX	3/8" & 1/2" Hex Impact Socket Set DIN TT1
1/9	TT9024	1/4" & 3/8" Impact Socket Set ANSI TT1
1/9	TTX3402E	1/4" Ratchet & Accessories Set TTX4
1/9	TT9116N	1/2" Impact Socket Set ANSI TT1
1/9	TT9212TX	1/2" TX Impact Socket Set DIN TT1
1/9	TT9207	1/2" Impact Socket Accessories Set DIN TT1
1/9	TTID20	1/2" Impact Driver Set TT1
1/9	TTX3414	3/4" Socket Set 6 pt TTX4
2/9	TTV3814	3/8" Insulated Socket Set TT1
2/9	TTV710N	Insulated Screwdriver Set Interchangeable Blades TT1
2/9	TTV440	Insulated Plier Set TT1
2/9	TTHEX23	1/2" Hex Bit Socket Set TT1
2/9	TTXND	Nut Driver Set TTX4
3/9	TTVG05	Power Grip Plier Set TT1
3/9	TTADJ04	Adjustable Wrench Set TT1
3/9	TTCP04	Crimping Plier Set TT1
3/9	TTCP121	Crimping Plier Set TT1
3/9	TTX6311	Double Ring Spanner Set TTX4
4/9	TTPS09	General Tool Set BP TT4
4/9	TTX2493	1/2" Torque Wrench & Breaker Bar Set TTX4
5/9	TTPSPG	Power Grip Plier Set TT4
5/9	TTX3892	3/8" Torque Wrench Set 20-110 Nm TTX4
6/9	TTDTD34	Tap and Die Set TT2
6/9	TTD01	Storage Tray TT2 8 Compartments
6/9	TTX01	Storage Tray TTX4 6 Compartments
7/9	TTNR81	Nutsert Gun Set TT1
7/9	TTHR81	Rivet Gun Set TT1
7/9	TTHP08	Hook & Pin Wrench Set TT1
7/9	TTBE18	Stud Extractor Set TT1
7/9	TTXPB3	Pry Bar Set Roll/Heel TTX4
8/9	TTOS16	Oil Service Set TT1
8/9	TTSN11	Extractor & Nut Splitter Set TT1
8/9	TT804	Puller Set TT1
8/9	TTHC03	Hose Clamp Set TT1
8/9	TTXPB3A	Pry Bar Set TTX4
9/9	EMPTY	
Side shelf	3401	3/4" Breaker Bar



TKS53R1295T

€15,799.00











PRO35™

MEGA MASTER™

26" PRO35™ MEGA MASTER TOOL KIT, 1033 PIECES, RED

1033
PIECES

TT
SERIES

-  16 Drawer
-  3-Piece Cabinet Frame
-  Heavy Gauge Steel
-  5-Step Phosphate-Free Rust Protection
-  26" Wide Cabinet
-  5" x 1-1/4" Castor Wheels with Brakes
-  3 Step Ball Bearing Slides
-  Comfort Grip Handle
-  Combination Lock

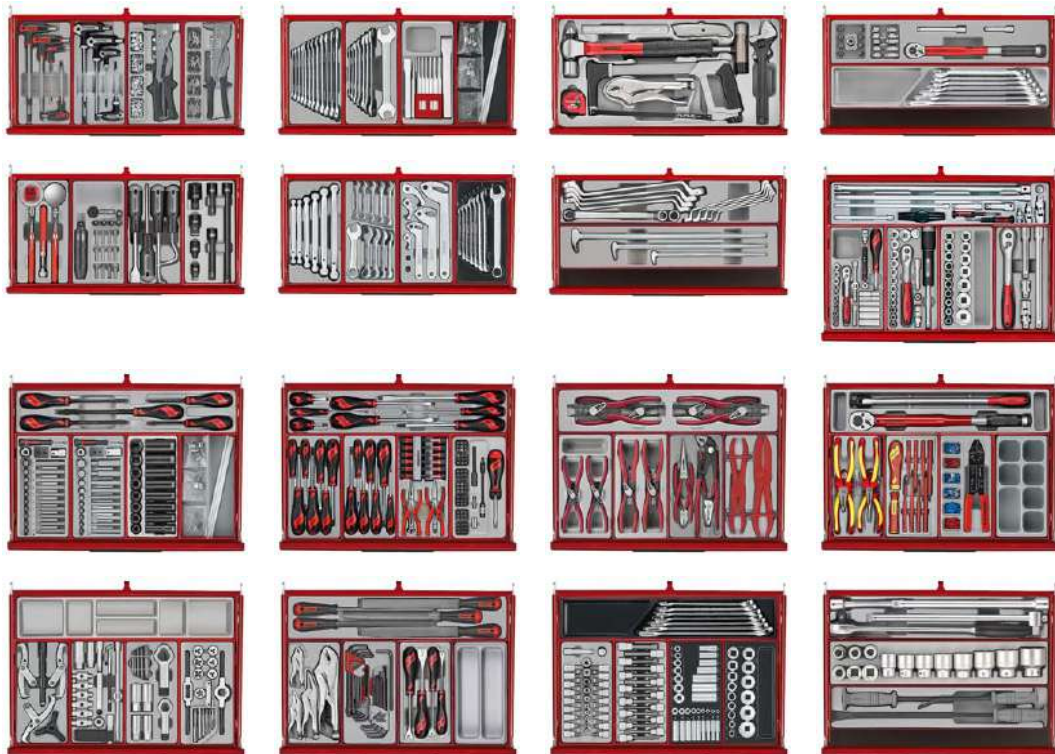

TST26R4	26" PRO35™ tool chest 4 drawers red	
TSM26R3	26" PRO35™ tool chest 3 drawers red	
TSW26R9	26" PRO35™ roller cabinet 9 drawers red	
TCF05	Fixing brackets for 26" 3-drawer tool chest	
TCA08	Paper roll holder for side handle	
580	Magnetic Bits Tray Round	
1/4	TTHX7	T-Handle Ball Point Hex Key Set TT1
1/4	TTTX7	T-Handle TX/TPX Key Set TT1
1/4	TTNR81	Nutsert Gun Set TT1
1/4	TTHR81	Rivet Gun Set TT1
2/4	TTI236	Combination Spanner Set TT1
2/4	TT6208	Double Open Ended Spanner Set TT1
2/4	TTPC09	Punch & Chisel Set TT1
2/4	TTALU	Clip Rail Set TT1
3/4	TTPS09	General Tool Set BP TT4
4/4	TTX3892	3/8" Torque Wrench Set 20-110 Nm TTX4
4/4	TTX2032	Combination Spanner Set TTX4
1/3	TTTM03	Inspection Set TT1
1/3	TTID20	1/2" Impact Driver Set TT1
1/3	TTSR04	Scraper Set TT1
1/3	TT9207A	1/2" Impact Socket Accessories Set ANSI TT1
2/3	TT6506	Double Flex Wrench Set TT1
2/3	TT6010M	Stubby Combination Spanner Set TT1
2/3	TTHP08	Hook & Pin Wrench Set TT1
2/3	TT3592	Combination Spanner Set AF TT1
3/3	TTX6311	Double Ring Spanner Set TTX4
3/3	TTXPB3	Pry Bar Set Roll/Heel TTX4
1/9	TTI435	1/4" Socket Set 6 pt TT1
1/9	TT3819	3/8" Socket Set 6 pt TT1
1/9	TTI217-6	1/2" Socket Set 6 pt TT1
1/9	TTI205	1/2" Ratchet & Accessories Set TT1
1/9	TTXEXT13	Extension Bars Set TTX4
2/9	TTTX23	1/2" TX Bit Socket Set TT1
2/9	TTHX23	1/2" Hex Bit Socket Set TT1
2/9	TT9116N	1/2" Impact Socket Set ANSI TT1
2/9	TTALU	Clip Rail Set TT1
2/9	TTXMDTN	Power Through Screwdriver Set TTX4

3/9	TT917N	Screwdriver Set Mixed TT1
3/9	TT917TXN	Screwdriver Set TX & TPX TT1
3/9	TTM116	Mini Pliers & Screwdriver Set TT1
3/9	TTMD74	Ratcheting Screwdriver Bit Set TT1
3/9	TTX918N	Screwdriver Set Flat & PH TTX4
4/9	TT474-5E	Circlip Plier Set PRO 12-25 mm TT1
4/9	TT474-7E	Circlip Plier Set PRO 19-60 mm TT1
4/9	TT440Q	Plier Set Vinyl Grip Q TT1
4/9	TTHC03	Hose Clamp Set TT1
4/9	TTX474-9E	Circlip Plier Set PRO 40-100 mm TTX4
5/9	TTV440	Insulated Plier Set TT1
5/9	TTV710N	Insulated Screwdriver Set Interchangeable Blades TT1
5/9	TTCP121	Crimping Plier Set TT1
5/9	TT01	Storage Tray TT1 7 Compartments
5/9	TTX2493	1/2" Torque Wrench & Breaker Bar Set TTX4
6/9	TT804	Puller Set TT1
6/9	TTOS16	Oil Service Set TT1
6/9	TTSN11	Extractor & Nut Splitter Set TT1
6/9	TTTD17	Tap and Die Set TT1
6/9	TTX01	Storage Tray TTX4 6 Compartments
7/9	TTVG05	Power Grip Plier Set TT1
7/9	TTHT28	Ball Point Hex & TX Key Set TT1
7/9	TTSR04A	Clip & Panel Remover Set TT1
7/9	TT02	Storage Tray TT1 2 Compartments
7/9	TTXF05	Hand File Set TTX4
8/9	TTTX30	3/8" TX Bit Socket Set TT1
8/9	TTRS15	1/2" Long Ribe & XZN Bit Socket Set TT1
8/9	TTAF32	1/4" & 3/8" Socket Set AF 6 pt TT1
8/9	TTI215AF	1/2" Socket Set 12 pt AF TT1
8/9	TTX2640	Combination Spanner Set AF TTX4
9/9	TTXPB3A	Pry Bar Set TTX4
9/9	TTX3414	3/4" Socket Set 6 pt TTX4
9/9	TTX3404	3/4" Ratchet & Accessories Set TTX4



TKS26R1033T

£8,999.00











PRO35™

MEGA MASTER™



26" PRO35™ MEGA MASTER TOOL KIT 1033 PIECES BLACK

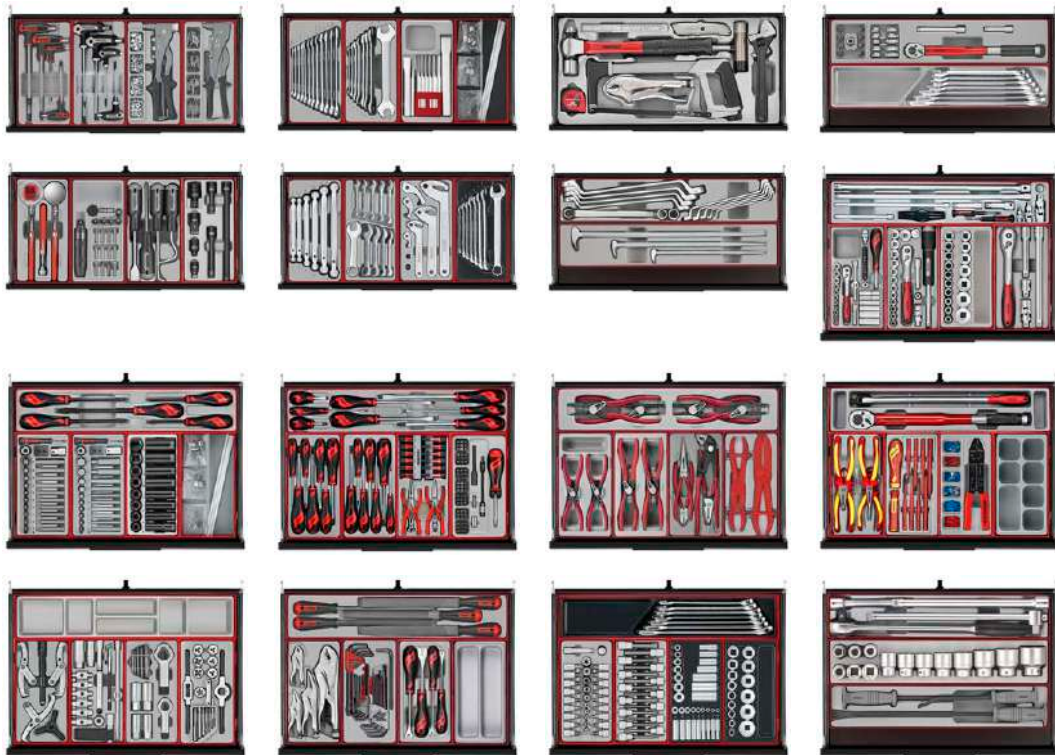

1033
PIECES

TT
SERIES

-  16 Drawer
-  3-Piece Cabinet Frame
-  Heavy Gauge Steel
-  5-Step Phosphate-Free Rust Protection
-  26" Wide Cabinet
-  5" x 1-1/4" Castor Wheels with Brakes
-  3 Step Ball Bearing Slides
-  Comfort Grip Handle
-  Combination Lock



		
TST26B4		26" PRO35™ tool chest 4 drawers black
TSM26B3		26" PRO35™ tool chest 3 drawers black
TSW26B9		26" PRO35™ roller cabinet 9 drawers black
TCF05		Fixing brackets for 26" 3-drawer tool chest
TCA08		Paper roll holder for side handle
580		Magnetic Bits Tray Round
1/4	TTHEX7	T-Handle Ball Point Hex Key Set TT1
1/4	TTTX7	T-Handle TX/TPX Key Set TT1
1/4	TTNR81	Nutsert Gun Set TT1
1/4	TTHR81	Rivet Gun Set TT1
2/4	TTI236	Combination Spanner Set TT1
2/4	TT6208	Double Open Ended Spanner Set TT1
2/4	TTPC09	Punch & Chisel Set TT1
2/4	TTALU	Clip Rail Set TT1
3/4	TTPS09	General Tool Set BP TT4
4/4	TTX3892	3/8" Torque Wrench Set 20-110 Nm TTX4
4/4	TTX2032	Combination Spanner Set TTX4
1/3	TTTM03	Inspection Set TT1
1/3	TTID20	1/2" Impact Driver Set TT1
1/3	TTSR04	Scraper Set TT1
1/3	TT9207A	1/2" Impact Socket Accessories Set ANSI TT1
2/3	TT6506	Double Flex Wrench Set TT1
2/3	TT6010M	Stubby Combination Spanner Set TT1
2/3	TTHP08	Hook & Pin Wrench Set TT1
2/3	TT3592	Combination Spanner Set AF TT1
3/3	TTX6311	Double Ring Spanner Set TTX4
3/3	TTXPB3	Pry Bar Set Roll/Heel TTX4
1/9	TT1435	1/4" Socket Set 6 pt TT1
1/9	TT3819	3/8" Socket Set 6 pt TT1
1/9	TT1217-6	1/2" Socket Set 6 pt TT1
1/9	TT1205	1/2" Ratchet & Accessories Set TT1
1/9	TTXEXT13	Extension Bars Set TTX4
2/9	TTTX23	1/2" TX Bit Socket Set TT1
2/9	TTHEX23	1/2" Hex Bit Socket Set TT1
2/9	TT9116N	1/2" Impact Socket Set ANSI TT1
2/9	TTALU	Clip Rail Set TT1
2/9	TTXMDTN	Power Through Screwdriver Set TTX4

		
3/9	TT917N	Screwdriver Set Mixed TT1
3/9	TT917TXN	Screwdriver Set TX & TPX TT1
3/9	TTM116	Mini Pliers & Screwdriver Set TT1
3/9	TTMD74	Ratcheting Screwdriver Bit Set TT1
3/9	TTX918N	Screwdriver Set Flat & PH TTX4
4/9	TT474-5E	Circlip Plier Set PRO 12-25 mm TT1
4/9	TT474-7E	Circlip Plier Set PRO 19-60 mm TT1
4/9	TT440Q	Plier Set Vinyl Grip Q TT1
4/9	TTHC03	Hose Clamp Set TT1
4/9	TTX474-9E	Circlip Plier Set PRO 40-100 mm TTX4
5/9	TTV440	Insulated Plier Set TT1
5/9	TTV710N	Insulated Screwdriver Set Interchangeable Blades TT1
5/9	TTCP121	Crimping Plier Set TT1
5/9	TT01	Storage Tray TT1 7 Compartments
5/9	TTX2493	1/2" Torque Wrench & Breaker Bar Set TTX4
6/9	TT804	Puller Set TT1
6/9	TTOS16	Oil Service Set TT1
6/9	TTSN11	Extractor & Nut Splitter Set TT1
6/9	TTTD17	Tap and Die Set TT1
6/9	TTX01	Storage Tray TTX4 6 Compartments
7/9	TTVG05	Power Grip Plier Set TT1
7/9	TTHT28	Ball Point Hex & TX Key Set TT1
7/9	TTSR04A	Clip & Panel Remover Set TT1
7/9	TT02	Storage Tray TT1 2 Compartments
7/9	TTXF05	Hand File Set TTX4
8/9	TTTX30	3/8" TX Bit Socket Set TT1
8/9	TTRS15	1/2" Long Ribe & XZN Bit Socket Set TT1
8/9	TTAF32	1/4" & 3/8" Socket Set AF 6 pt TT1
8/9	TT1215AF	1/2" Socket Set 12 pt AF TT1
8/9	TTX2640	Combination Spanner Set AF TTX4
9/9	TTXPB3A	Pry Bar Set TTX4
9/9	TTX3414	3/4" Socket Set 6 pt TTX4
9/9	TTX3404	3/4" Ratchet & Accessories Set TTX4



TKS26B1033T

£8,999.00



PRO35™



26" PRO35™ STACK TOOL KIT 1034 PIECES RED

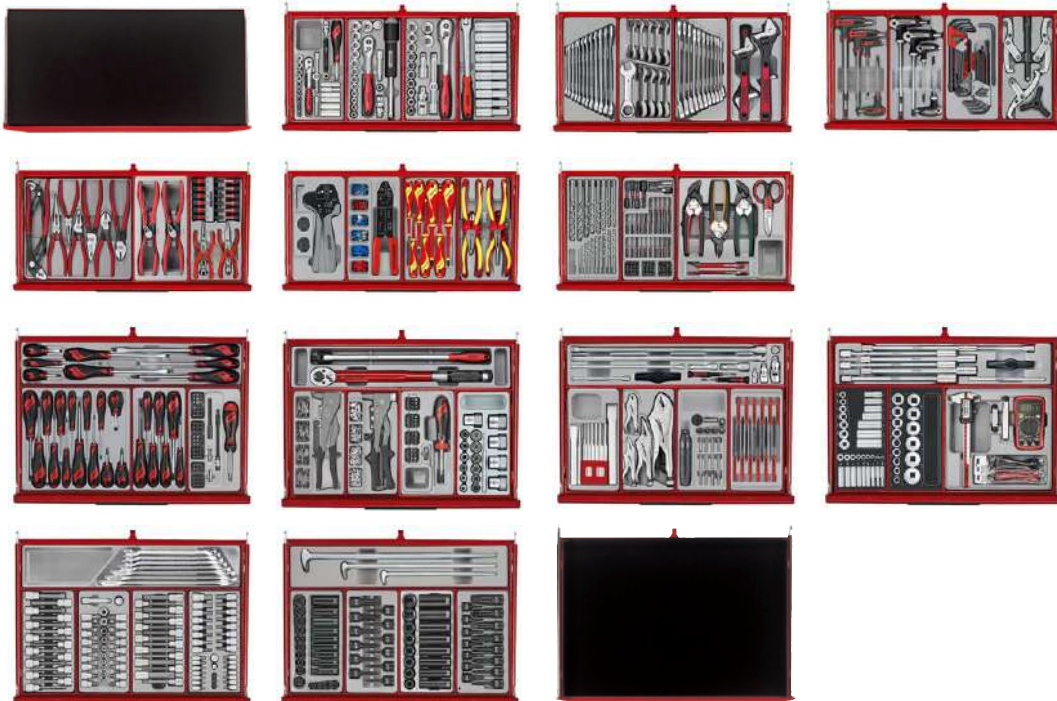

1034
PIECES

TT
SERIES

- 14 Drawer
- 3-Piece Cabinet Frame
- Heavy Gauge Steel
- 5-Step Phosphate-Free Rust Protection
- 26" Wide Cabinet
- 5" x 1-1/4" Castor Wheels with Brakes
- 3 Step Ball Bearing Slides
- Comfort Grip Handle
- Combination Lock



		
		TST26R4 26" PRO35™ tool chest 4 drawers red
		TSM26R3 26" PRO35™ tool chest 3 drawers red
		TSW26R7 26" PRO35™ roller cabinet 7 drawers red
		TCF05 Fixing brackets for 26" 3-drawer tool chest
		TCA08 Paper roll holder for side handle
1/4	EMPTY	
2/4	TT1435I2	1/4" Socket Set 12 pt TT1
2/4	TT3819I2	3/8" Socket Set 12 pt TT1
2/4	TT12I8	1/2" Socket Set 12 pt TT1
2/4	TT12I1	1/2" Deep Socket Set 12 pt TT1
3/4	TT1236	Combination Spanner Set TT1
3/4	TT6010MRS	Stubby Ratcheting Combination Spanner Set TT1
3/4	TT6511R	Ratcheting Combination Spanner Set R TT1
3/4	TTADJ04	Adjustable Wrench Set TT1
4/4	TTHEX7	T-Handle Ball Point Hex Key Set TT1
4/4	TTTX7	T-Handle TX/TPX Key Set TT1
4/4	TTHT28	Ball Point Hex & TX Key Set TT1
4/4	TT804	Puller Set TT1
1/3	TTD44IQ	Plier Set Vinyl Grip Q TT2
1/3	TT474-7E	Circlip Plier Set PRO 19-60 mm TT1
1/3	TTMI16	Mini Pliers & Screwdriver Set TT1
2/3	TTCP04	Crimping Plier Set TT1
2/3	TTCP12I	Crimping Plier Set TT1
2/3	TTV907N	Insulated Screwdriver Set Mixed TT1
2/3	TTV440	Insulated Plier Set TT1
3/3	TTDB28	Drill Bit Set 1.0-13.0 mm TT1
3/3	TTB553	Impact Bit Set TT1
3/3	TTDCT06	Cutting Tool Set TT2
1/7	TTD914N	Screwdriver Set Mixed TT2
1/7	TT917TXN	Screwdriver Set TX & TPX TT1
1/7	TTMD74	Ratcheting Screwdriver Bit Set TT1
1/7	TTX918N	Screwdriver Set Flat & PH TTX4
2/7	TTHR81	Rivet Gun Set TT1
2/7	TTNR81	Nutsert Gun Set TT1
2/7	TTSD38	Torque Screwdriver Set TT1
2/7	TTBE18	Stud Extractor Set TT1
2/7	TTX2493	1/2" Torque Wrench & Breaker Bar Set TTX4

		
3/7	TTPC09	Punsch & Chisel Set TT1
3/7	TTVG05	Power Grip Plier Set TT1
3/7	TTID20	1/2" Impact Driver Set TT1
3/7	TTNF12	Needle File Set TT1
3/7	TTXEXT13	Extension Bars Set TTX4
4/7	TTAF32	1/4" & 3/8" Socket Set AF 6 pt TT1
4/7	TT12I5AF	1/2" Socket Set 12 pt AF TT1
4/7	TTDCM	Measuring Tool Set TT2
4/7	TTXTB09	3/8" Long T Bar Socket Set TTX4
5/7	TTTXH15	1/2" Long Hex & TX Bit Socket Set TT1
5/7	TTTX30	3/8" TX Bit Socket Set TT1
5/7	TTRS15	1/2" Long Ribe & XZN Bit Socket Set TT1
5/7	TTBS35	1/4" & 3/8" Bit Socket Set TT1
5/7	TTX2032	Combination Spanner Set TTX4
6/7	TT9024	1/4" & 3/8" Impact Socket Set ANSI TT1
6/7	TT9212TX	1/2" TX Impact Socket Set DIN TT1
6/7	TT9116N	1/2" Impact Socket Set ANSI TT1
6/7	TT9015HX	3/8" & 1/2" Hex Impact Socket Set DIN TT1
6/7	TTXPB3	Pry Bar Set Roll/Heel TTX4
7/7	EMPTY	



TKS26R1034T

£9,149.00











PRO35™

26" PRO35™ STACK TOOL KIT 753 PIECES RED

753
PIECES

TT
SERIES

-  **16** Drawer
-  **3-Piece Cabinet Frame**
-  **Heavy Gauge Steel**
-  **5-Step Phosphate-Free Rust Protection**
-  **26" Wide Cabinet**
-  **5" x 1-1/4" Castor Wheels with Brakes**
-  **3 Step Ball Bearing Slides**
-  **Comfort Grip Handle**
-  **Combination Lock**

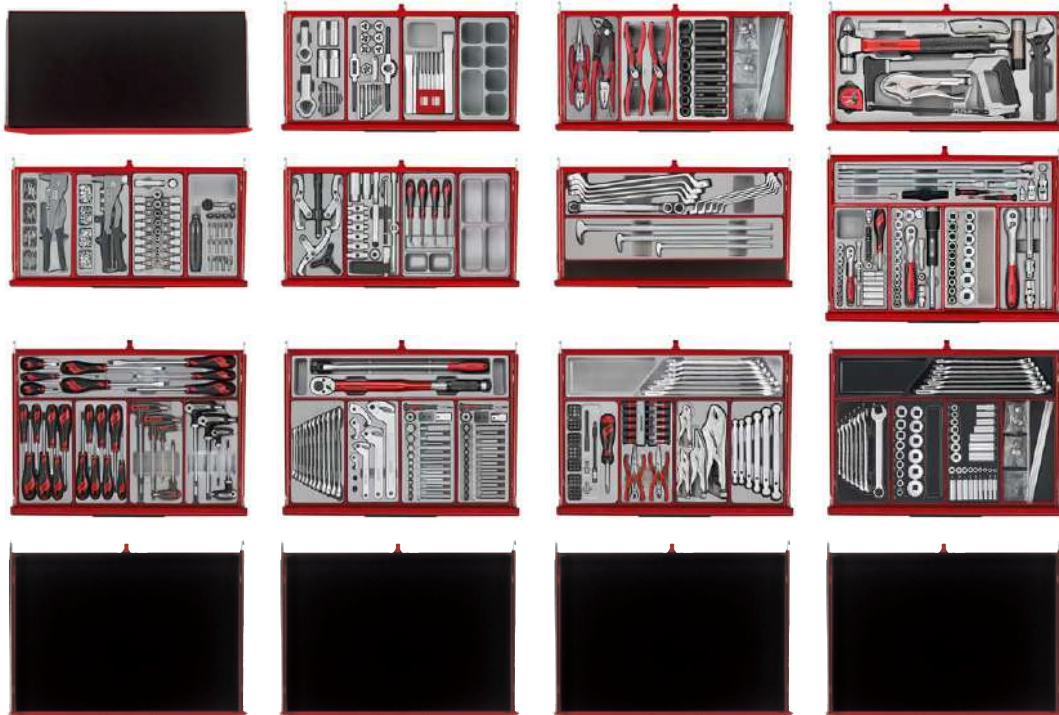

	TST26R4	26" PRO35™ tool chest 4 drawers red	
	TSM26R3	26" PRO35™ tool chest 3 drawers red	
	TSW26R9	26" PRO35™ roller cabinet 9 drawers red	
	TCF05	Fixing brackets for 26" 3-drawer tool chest	
	TCA08	Paper roll holder for side handle	
1/4	EMPTY		
2/4	TTSN11	Extractor & Nut Splitter Set TT1	
2/4	TTTD17	Tap and Die Set TT1	
2/4	TTPC09	Punch & Chisel Set TT1	
2/4	TT01	Storage Tray TT1 7 Compartments	
3/4	TT440Q	Plier Set Vinyl Grip Q TT1	
3/4	TT474-7E	Circlip Plier Set PRO 19-60 mm TT1	
3/4	TT9116N	1/2" Impact Socket Set ANSI TT1	
3/4	TTALU	Clip Rail Set TT1	
4/4	TTPS09	General Tool Set BP TT4	
1/3	TTHR81	Rivet Gun Set TT1	
1/3	TTNR81	Nutsert Gun Set TT1	
1/3	TTTX30	3/8" TX Bit Socket Set TT1	
1/3	TTID20	1/2" Impact Driver Set TT1	
2/3	TT804	Puller Set TT1	
2/3	TTOS16	Oil Service Set TT1	
2/3	TTMDP	Hook & Pick Set TT1	
2/3	TT03	Storage Tray TT1 4 Compartments	
3/3	TTX6311	Double Ring Spanner Set TTX4	
3/3	TTXPB3	Pry Bar Set Roll/Heel TTX4	
1/9	TT1435	1/4" Socket Set 6 pt TT1	
1/9	TT3819	3/8" Socket Set 6 pt TT1	
1/9	TT1217-6	1/2" Socket Set 6 pt TT1	
1/9	TT1205	1/2" Ratchet & Accessories Set TT1	
1/9	TTXEXT13	Extension Bars Set TTX4	
2/9	TT917N	Screwdriver Set Mixed TT1	
2/9	TT917TXN	Screwdriver Set TX & TPX TT1	
2/9	TTHEX7	T-Handle Ball Point Hex Key Set TT1	
2/9	TTTX7	T-Handle TX/TPX Key Set TT1	
2/9	TTX918N	Screwdriver Set Flat & PH TTX4	

3/9	TT1236	Combination Spanner Set TT1	
3/9	TTHP08	Hook & Pin Wrench Set TT1	
3/9	TTHEX23	1/2" Hex Bit Socket Set TT1	
3/9	TTTX23	1/2" TX Bit Socket Set TT1	
3/9	TTX2493	1/2" Torque Wrench & Breaker Bar Set TTX4	
4/9	TTMD74	Ratcheting Screwdriver Bit Set TT1	
4/9	TTM116	Mini Pliers & Screwdriver Set TT1	
4/9	TTVG05	Power Grip Plier Set TT1	
4/9	TT6506	Double Flex Wrench Set TT1	
4/9	TTX2032	Combination Spanner Set TTX4	
5/9	TT3592	Combination Spanner Set AF TT1	
5/9	TT1215AF	1/2" Socket Set 12 pt AF TT1	
5/9	TTAF32	1/4" & 3/8" Socket Set AF 6 pt TT1	
5/9	TTX2640	Combination Spanner Set AF TTX4	
5/9	TTALU	Clip Rail Set TT1	
6/9	EMPTY		
7/9	EMPTY		
8/9	EMPTY		
9/9	EMPTY		



TKS26R753T

£6,799.00



PRO35™

53" PRO35™ ROLLER CABINET TOOL KIT 615 PIECES RED

615
PIECES

TT
SERIES

- 9 Drawer
- 3-Piece Cabinet Frame
- Heavy Gauge Steel
- 5-Step Phosphate-Free Rust Protection
- 53" Wide Cabinet
- 6" x 2" Castor Wheels with Brakes
- 3 Step Ball Bearing Slides
- Comfort Grip Handle
- Combination Lock



TT		TT	
	TSW53R9	53" PRO35™ roller cabinet 9 drawers red	
	TCA08	Paper roll holder for side handle	
1/9	EMPTY		
2/9	TT1435	1/4" Socket Set 6 pt TT1	
2/9	TT3819	3/8" Socket Set 6 pt TT1	
2/9	TT1217-6	1/2" Socket Set 6 pt TT1	
2/9	TT1205	1/2" Ratchet & Accessories Set TT1	
2/9	TTXEXT13	Extension Bars Set TTX4	
3/9	TT440Q	Plier Set Vinyl Grip Q TT1	
3/9	TT474-7E	Circlip Plier Set PRO 19-60 mm TT1	
3/9	TTDCT05	Cutting Tool Set TT2	
3/9	TTX474-9E	Circlip Plier Set PRO 40-100 mm TTX4	
4/9	TTTX30	3/8" TX Bit Socket Set TT1	
4/9	TTBS35	1/4" & 3/8" Bit Socket Set TT1	
4/9	TTTXH15	1/2" Long Hex & TX Bit Socket Set TT1	
4/9	TTRS15	1/2" Long Ribe & XZN Bit Socket Set TT1	
4/9	TTXF05	Hand File Set TTX4	
5/9	TT3816	3/8" Socket Set 6 pt TT1	
5/9	TTAF32	1/4" & 3/8" Socket Set AF 6 pt TT1	
5/9	TT1215AF	1/2" Socket Set 12 pt AF TT1	
5/9	TT3592	Combination Spanner Set AF TT1	
5/9	TTX2640	Combination Spanner Set AF TTX4	
6/9	TT917N	Screwdriver Set Mixed TT1	
6/9	TT917TXN	Screwdriver Set TX & TPX TT1	
6/9	TTMD74	Ratcheting Screwdriver Bit Set TT1	
6/9	TTMDQ49	Bits Driver Set TT1	
6/9	TTX918N	Screwdriver Set Flat & PH TTX4	

TT		TT	
7/9	TTPC09	Punsch & Chisel Set TT1	
7/9	TTVG05	Power Grip Plier Set TT1	
7/9	TT1236	Combination Spanner Set TT1	
7/9	TT6508R	Ratcheting Combination Spanner Set R TT1	
7/9	TTX2032	Combination Spanner Set TTX4	
8/9	TTHEX7	T-Handle Ball Point Hex Key Set TT1	
8/9	TTTX7	T-Handle TX/TPX Key Set TT1	
8/9	TTHT28	Ball Point Hex & TX Key Set TT1	
8/9	TTDB28	Drill Bit Set 1.0-13.0 mm TT1	
8/9	TTX3414	3/4" Socket Set 6 pt TTX4	
9/9	TT9207	1/2" Impact Socket Accessories Set DIN TT1	
9/9	TT9120DN	1/2" Impact Socket Set DIN TT1	
9/9	TTID20	1/2" Impact Driver Set TT1	
9/9	TTBM	Measuring Tool Set TT1	
9/9	TTX3404	3/4" Ratchet & Accessories Set TTX4	



TKW53R615T

£7,799.00











PRO35™

37" PRO35™ ROLLER CABINET TOOL KIT 1008 PIECES BLACK

1008
PIECES

TT
SERIES

-  **8** Drawer
-  **3-Piece Cabinet Frame**
-  **Heavy Gauge Steel**
-  **5-Step Phosphate-Free Rust Protection**
-  **37" Wide Cabinet**
-  **5" x 2" Castor Wheels with Brakes**
-  **3 Step Ball Bearing Slides**
-  **Comfort Grip Handle**
-  **Combination Lock**



*Paper roll not included.

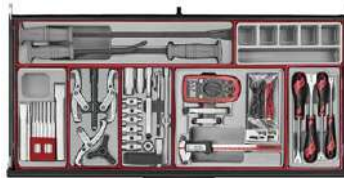
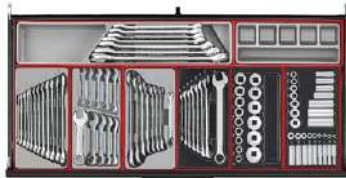

	TSW37B8	37" PRO35™ roller cabinet 8 drawers black	
	TC-TB03	Work Top for 37" Cabinet	
	TCATV	Side Shelf for Vice	
	TCA01	Paper Roll Holder	
	TCAV4	4" Work Bench Vice	
	580	Magnetic Bits Tray Round	
1/8	TT1435	1/4" Socket Set 6 pt TT1	
1/8	TT3819	3/8" Socket Set 6 pt TT1	
1/8	TT3816	3/8" Socket Set 6 pt TT1	
1/8	TTADP17	Socket Adaptor Set TT1	
1/8	TTTX30	3/8" TX Bit Socket Set TT1	
1/8	TT9015HX	3/8" & 1/2" Hex Impact Socket Set DIN TT1	
1/8	TTXEXT13	Extension Bars Set TTX4	
1/8	TTZ01	Storage Tray TTX2 6 Compartments	
2/8	TT1205	1/2" Ratchet & Accessories Set TT1	
2/8	TT1211	1/2" Deep Socket Set 12 pt TT1	
2/8	TT1217-6	1/2" Socket Set 6 pt TT1	
2/8	TTHEX16	1/2" Hex Bit Socket Set TT1	
2/8	TTID20	1/2" Impact Driver Set TT1	
2/8	TT9116N	1/2" Impact Socket Set ANSI TT1	
2/8	TTX2493	1/2" Torque Wrench & Breaker Bar Set TTX4	
2/8	TTZ01	Storage Tray TTX2 6 Compartments	
3/8	TTHT28	Ball Point Hex & TX Key Set TT1	
3/8	TT917TXN	Screwdriver Set TX & TPX TT1	
3/8	TTHEX7	T-Handle Ball Point Hex Key Set TT1	
3/8	TTTX7	T-Handle TX/TPX Key Set TT1	
3/8	TTB553	Impact Bit Set TT1	
3/8	TTMDR84	Ratcheting Bits Driver Set TT1	
3/8	TTX918N	Screwdriver Set Flat & PH TTX4	
3/8	TTZ01	Storage Tray TTX2 6 Compartments	
4/8	TT1236	Combination Spanner Set TT1	
4/8	TT6010M	Stubby Combination Spanner Set TT1	
4/8	TT6508R	Ratcheting Combination Spanner Set R TT1	
4/8	TT3592	Combination Spanner Set AF TT1	
4/8	TT1215AF	1/2" Socket Set 12 pt AF TT1	
4/8	TTAF32	1/4" & 3/8" Socket Set AF 6 pt TT1	
4/8	TTX2032	Combination Spanner Set TTX4	

4/8	TTZ01	Storage Tray TTX2 6 Compartments	
5/8	TTD441Q	Plier Set Vinyl Grip Q TT2	
5/8	TT474-7E	Circlip Plier Set PRO 19-60 mm TT1	
5/8	TTM116	Mini Pliers & Screwdriver Set TT1	
5/8	TTHR81	Rivet Gun Set TT1	
5/8	TTNR81	Nutsert Gun Set TT1	
5/8	TTX474-9E	Circlip Plier Set PRO 40-100 mm TTX4	
5/8	TTZVG03	Power Grip Plier Set TTX2	
6/8	TTD914N	Screwdriver Set Mixed TT2	
6/8	TTMDQ49	Bits Driver Set TT1	
6/8	TTCP121	Crimping Plier Set TT1	
6/8	TTV907N	Insulated Screwdriver Set Mixed TT1	
6/8	TTV440	Insulated Plier Set TT1	
6/8	TTX3892	3/8" Torque Wrench Set 20-110 Nm TTX4	
6/8	TTZ01	Storage Tray TTX2 6 Compartments	
7/8	TTPS09	General Tool Set BP TT4	
7/8	TTSR04	Scraper Set TT1	
7/8	TTTM03	Inspection Set TT1	
7/8	TTX2640	Combination Spanner Set AF TTX4	
7/8	TTZ01	Storage Tray TTX2 6 Compartments	
8/8	TTPC09	Punch & Chisel Set TT1	
8/8	TT804	Puller Set TT1	
8/8	TTOS16	Oil Service Set TT1	
8/8	TTDCM	Measuring Tool Set TT2	
8/8	TTSR04A	Clip & Panel Remover Set TT1	
8/8	TTXPB3A	Pry Bar Set TTX4	
8/8	TTZ01	Storage Tray TTX2 6 Compartments	



TTW37B1008T

£8,499.00



PRO35™



37" PRO35™ ROLLER CABINET TOOL KIT 663 PIECES RED



663
PIECES

TT
SERIES

- 7 Drawer
- 3-Piece Cabinet Frame
- Heavy Gauge Steel
- 5-Step Phosphate-Free Rust Protection
- 37" Wide Cabinet
- 5" x 2" Castor Wheels with Brakes
- 3 Step Ball Bearing Slides
- Comfort Grip Handle
- Combination Lock



		
	TSW37R7	37" PRO35™ roller cabinet 7 drawers red
	TC-TB03	Work Top for 37" Cabinet
	TCA08	Paper roll holder for side handle
1/7	TT1435	1/4" Socket Set 6 pt TT1
1/7	TT3819	3/8" Socket Set 6 pt TT1
1/7	TT1205	1/2" Ratchet & Accessories Set TT1
1/7	TT1217-6	1/2" Socket Set 6 pt TT1
1/7	TTHEX7	T-Handle Ball Point Hex Key Set TT1
1/7	TTTX7	T-Handle TX/TPX Key Set TT1
1/7	TTXEXT13	Extension Bars Set TTX4
1/7	TTZ01	Storage Tray TTX2 6 Compartments
2/7	TT1236	Combination Spanner Set TT1
2/7	TTOS16	Oil Service Set TT1
2/7	TTSN11	Extractor & Nut Splitter Set TT1
2/7	TT440Q	Plier Set Vinyl Grip Q TT1
2/7	TT474-7E	Circlip Plier Set PRO 19-60 mm TT1
2/7	TTMI16	Mini Pliers & Screwdriver Set TT1
2/7	TTX2032	Combination Spanner Set TTX4
2/7	TTZVG03	Power Grip Plier Set TTX2
3/7	TT3592	Combination Spanner Set AF TT1
3/7	TTAF32	1/4" & 3/8" Socket Set AF 6 pt TT1
3/7	TT1215AF	1/2" Socket Set 12 pt AF TT1
3/7	TTTX30	3/8" TX Bit Socket Set TT1
3/7	TTTD17	Tap and Die Set TT1
3/7	TT804	Puller Set TT1
3/7	TTX2640	Combination Spanner Set AF TTX4
3/7	TTZ01	Storage Tray TTX2 6 Compartments
4/7	TTPS09	General Tool Set BP TT4
4/7	TT917N	Screwdriver Set Mixed TT1
4/7	TT917TXN	Screwdriver Set TX & TPX TT1
4/7	TTX918N	Screwdriver Set Flat & PH TTX4
4/7	TTZ01	Storage Tray TTX2 6 Compartments

		
5/7	TT9116N	1/2" Impact Socket Set ANSI TT1
5/7	TTHEX23	1/2" Hex Bit Socket Set TT1
5/7	TTTX23	1/2" TX Bit Socket Set TT1
5/7	TTMD74	Ratcheting Screwdriver Bit Set TT1
5/7	TTID20	1/2" Impact Driver Set TT1
5/7	TTALU	Clip Rail Set TT1
5/7	TTX2493	1/2" Torque Wrench & Breaker Bar Set TTX4
5/7	TTZ01	Storage Tray TTX2 6 Compartments
6/7	TTXMD4IN	Socket & Bit Set Flexible Handle TTX4
6/7	TTX6311	Double Ring Spanner Set TTX4
6/7	TTXPB3	Pry Bar Set Roll/Heel TTX4
6/7	TTNR81	Nutsert Gun Set TT1
6/7	TTPC09	Punch & Chisel Set TT1
6/7	TTZ01	Storage Tray TTX2 6 Compartments
7/7	EMPTY	



TKW37R663T

£5,899.00



PRO35™



37" PRO35™ ROLLER CABINET TOOL KIT 595 PIECES RED

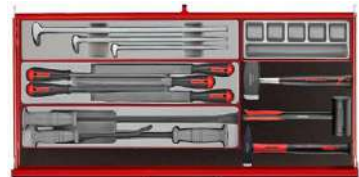

595
PIECES

TT
SERIES

- 7 Drawer
- 3-Piece Cabinet Frame
- Heavy Gauge Steel
- 5-Step Phosphate-Free Rust Protection
- 37" Wide Cabinet
- 5" x 2" Castor Wheels with Brakes
- 3 Step Ball Bearing Slides
- Comfort Grip Handle
- Combination Lock



		
	TSW37R7	37" PRO35™ roller cabinet 7 drawers red
	TC-TB03	Work Top for 37" Cabinet
	580T	Side shelf for roller cabinet 457 x 100 x 50mm
1/7	TT1435	1/4" Socket Set 6 pt TT1
1/7	TT3819	3/8" Socket Set 6 pt TT1
1/7	TT1205	1/2" Ratchet & Accessories Set TT1
1/7	TT1217-6	1/2" Socket Set 6 pt TT1
1/7	TTHEX23	1/2" Hex Bit Socket Set TT1
1/7	TTTX23	1/2" TX Bit Socket Set TT1
1/7	TTXEXT13	Extension Bars Set TTX4
1/7	TTZ01	Storage Tray TTX2 6 Compartments
2/7	TTHEX7	T-Handle Ball Point Hex Key Set TT1
2/7	TTTX7	T-Handle TX/TPX Key Set TT1
2/7	TT917N	Screwdriver Set Mixed TT1
2/7	TT917TXN	Screwdriver Set TX & TPX TT1
2/7	TTM116	Mini Pliers & Screwdriver Set TT1
2/7	TTMD74	Ratcheting Screwdriver Bit Set TT1
2/7	TTX918N	Screwdriver Set Flat & PH TTX4
2/7	TTZ01	Storage Tray TTX2 6 Compartments
3/7	TT1236	Combination Spanner Set TT1
3/7	TTADJ04	Adjustable Wrench Set TT1
3/7	TTVG05	Power Grip Plier Set TT1
3/7	TTPC09	Punsch & Chisel Set TT1
3/7	TTTX30	3/8" TX Bit Socket Set TT1
3/7	TTNR81	Nutsert Gun Set TT1
3/7	TTX6311	Double Ring Spanner Set TTX4
3/7	TTZ01	Storage Tray TTX2 6 Compartments
4/7	TT9116N	1/2" Impact Socket Set ANSI TT1
4/7	TT9212TX	1/2" TX Impact Socket Set DIN TT1
4/7	TT9015HX	3/8" & 1/2" Hex Impact Socket Set DIN TT1
4/7	TTID20	1/2" Impact Driver Set TT1
4/7	TT440Q	Plier Set Vinyl Grip Q TT1
4/7	TT474-7E	Circlip Plier Set PRO 19-60 mm TT1
4/7	TTX2493	1/2" Torque Wrench & Breaker Bar Set TTX4
4/7	TTZ01	Storage Tray TTX2 6 Compartments

		
5/7	TTPS09	General Tool Set BP TT4
5/7	TT804	Puller Set TT1
5/7	TTTD17	Tap and Die Set TT1
5/7	TTXMDTN	Power Through Screwdriver Set TTX4
5/7	TTZ01	Storage Tray TTX2 6 Compartments
6/7	TTXPB3A	Pry Bar Set TTX4
6/7	TTXF05	Hand File Set TTX4
6/7	TTXPB3	Pry Bar Set Roll/Heel TTX4
6/7	HMEG800	Engineers Hammer 800g
6/7	HMDH70PU	Deadblow Hammer PU 70mm 1500g
6/7	HMS1250	Lump Hammer 1250g
6/7	TTZ01	Storage Tray TTX2 6 Compartments
7/7	TTX2032	Combination Spanner Set TTX4
7/7	TTX3402E	3/4" Ratchet & Accessories Set TTX4
7/7	TTX3414	3/4" Socket Set 6 pt TTX4
7/7	TTOS16	Oil Service Set TT1
7/7	TTSN11	Extractor & Nut Splitter Set TT1
SIDE SHELF	3401	3/4" Breaker Bar



TKW37R595T

£7,249.00



PRO35™

26" PRO35™ ROLLER CABINET TOOL KIT 516 PIECES RED

516
PIECES

TT
SERIES

- 7** Drawer
- 3-Piece Cabinet Frame**
- Heavy Gauge Steel**
- 5-Step Phosphate-Free Rust Protection**
- 26" Wide Cabinet**
- 5" x 1-1/4" Castor Wheels with Brakes**
- 3 Step Ball Bearing Slides**
- Comfort Grip Handle**
- Combination Lock**

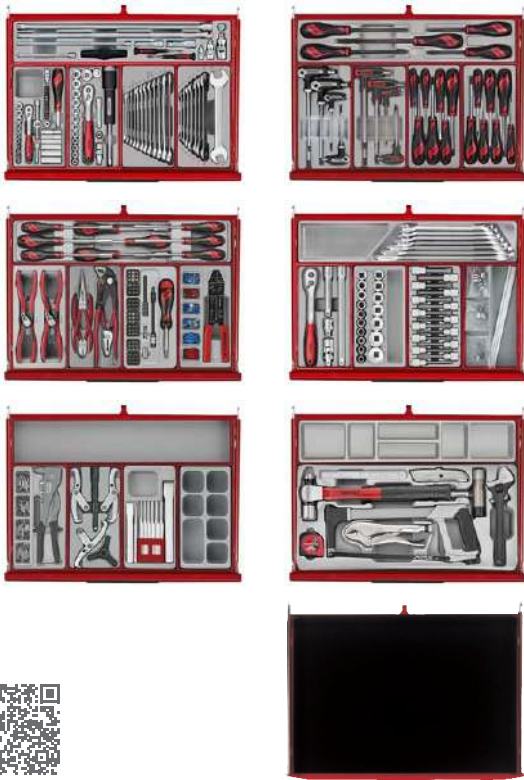

TKW26R516T

£3,629.00



Item Code	Description
TSW26R7	26" PRO35™ roller cabinet 7 drawers red
TCA08	Paper roll holder for side handle
1/7 TTI435	1/4" Socket Set 6 pt TT1
1/7 TT3819	3/8" Socket Set 6 pt TT1
1/7 TTI236	Combination Spanner Set TT1
1/7 TT6208	Double Open Ended Spanner Set TT1
1/7 TTXEXT13	Extension Bars Set TTX4
2/7 TTTX7	T-Handle TX/TPX Key Set TT1
2/7 TTHEX7	T-Handle Ball Point Hex Key Set TT1
2/7 TT917N	Screwdriver Set Mixed TT1
2/7 TT917TXN	Screwdriver Set TX & TPX TT1
2/7 TTXMDTN	Power Through Screwdriver Set TTX4
3/7 TT474-7E	Circlip Plier Set PRO 19-60 mm TT1
3/7 TT440Q	Plier Set Vinyl Grip Q TT1
3/7 TTMD74	Ratcheting Screwdriver Bit Set TT1
3/7 TTCPI21	Crimping Plier Set TT1
3/7 TTXND	Nut Driver Set TTX4
4/7 TT1205	1/2" Ratchet & Accessories Set TT1
4/7 TT1217-6	1/2" Socket Set 6 pt TT1
4/7 TTTXH15	1/2" Long Hex & TX Bit Socket Set TT1
4/7 TTALU	Clip Rail Set TT1
4/7 TTX2032	Combination Spanner Set TTX4
5/7 TT8R81	Rivet Gun Set TT1
5/7 TT804	Puller Set TT1
5/7 TTPC09	Punch & Chisel Set TT1
5/7 TT01	Storage Tray TT1 7 Compartments
5/7 TTX00	Storage Tray TTX4 1 Compartment
6/7 TT509	General Tool Set BP TT4
6/7 TTX01	Storage Tray TTX4 6 Compartments
7/7 EMPTY	



628
PIECES

TT
SERIES

26" PRO35™ ROLLER CABINET TOOL KIT 628 PIECES RED

- 7 Drawer**
- 3-Piece Cabinet Frame**
- Heavy Gauge Steel**
- 5-Step Phosphate-Free Rust Protection**
- 26" Wide Cabinet**
- 5" x 1-1/4" Castor Wheels with Brakes**
- 3 Step Ball Bearing Slides**
- Comfort Grip Handle**
- Combination Lock**



TSW26R7	26" PRO35™ roller cabinet 7 drawers red	
TCA08	Paper roll holder for side handle	

1/7	TT143512	1/4" Socket Set 12 pt TT1
1/7	TT381912	3/8" Socket Set 12 pt TT1
1/7	TT1205	1/2" Ratchet & Accessories Set TT1
1/7	TT1217	1/2" Socket Set 12 pt TT1
1/7	TTXEXT13	Extension Bars Set TTX4
2/7	TT917N	Screwdriver Set Mixed TT1
2/7	TT917TXN	Screwdriver Set TX & TPX TT1
2/7	TTMD74	Ratcheting Screwdriver Bit Set TT1
2/7	TTHT28	Ball Point Hex & TX Key Set TT1
2/7	TTXMDTN	Power Through Screwdriver Set TTX4
3/7	TT1236	Combination Spanner Set TT1
3/7	TT6208	Double Open Ended Spanner Set TT1
3/7	TTHEX7	T-Handle Ball Point Hex Key Set TT1
3/7	TTTX7	T-Handle TX/TPX Key Set TT1
3/7	TTX2032	Combination Spanner Set TTX4
4/7	TT440Q	Plier Set Vinyl Grip Q TT1
4/7	TT474-7E	Circlip Plier Set PRO 19-60 mm TT1
4/7	TTCP121	Crimping Plier Set TT1
4/7	TTALU	Clip Rail Set TT1
4/7	TTX00	Storage Tray TTX4 1 Compartment
5/7	TT804	Puller Set TT1
5/7	TTPC09	Punsch & Chisel Set TT1
5/7	TTTXH15	1/2" Long Hex & TX Bit Socket Set TT1
5/7	TT9116N	1/2" Impact Socket Set ANSI TT1
5/7	TTXND	Nut Driver Set TTX4
6/7	TTHR81	Rivet Gun Set TT1
6/7	TT1448	1/4" Socket & Bits Set TT1
6/7	TTNF12	Needle File Set TT1
6/7	TTSR04	Scraper Set TT1
6/7	TTX01	Storage Tray TTX4 6 Compartments
7/7	TTPS09	General Tool Set BP TT4
7/7	TTXF05	Hand File Set TTX4

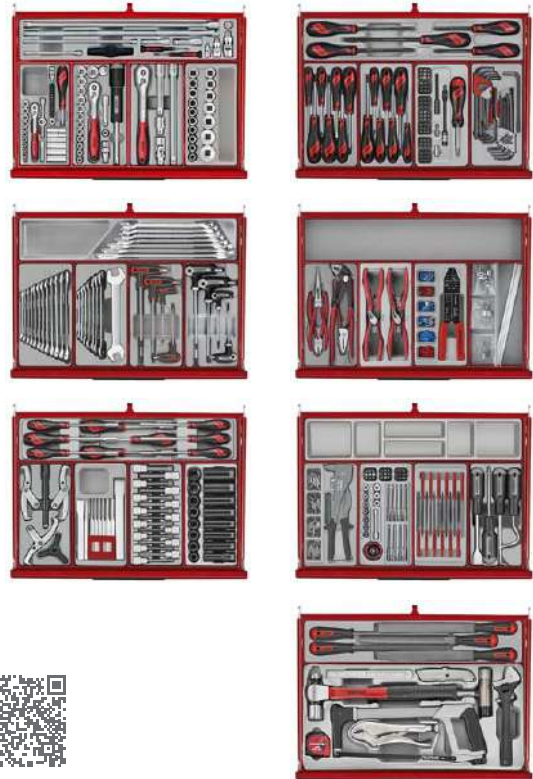

TKW26R628T

£4,019.00









PRO35™



26" PRO35™ TOOL CHEST TOOL KIT 137 PIECES RED

137
PIECES

TT
SERIES

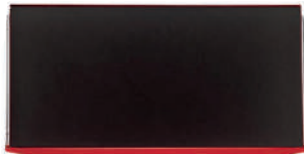
-  **4 Drawer**
-  **Heavy Gauge Steel**
-  **5-Step Phosphate-Free Rust Protection**
-  **26" Wide Cabinet**
-  **3 Step Ball Bearing Slides**
-  **Comfort Grip Handle**
-  **Combination Lock**



		
	TST26R4	26" PRO35™ tool chest 4 drawers red
1/4	TT1435	1/4" Socket Set 6 pt TT1
1/4	TT3819	3/8" Socket Set 6 pt TT1
1/4	TT1205	1/2" Ratchet & Accessories Set TT1
1/4	TT1217-6	1/2" Socket Set 6 pt TT1
2/4	TT1236	Combination Spanner Set TT1
2/4	TT917N	Screwdriver Set Mixed TT1
2/4	TTHT28	Ball Point Hex & TX Key Set TT1
2/4	TT440Q	Plier Set Vinyl Grip Q TT1
3/4	TTPS09	General Tool Set BP TT4
4/4	EMPTY	



TKT26R137T

£1,529.00

MECCA PRO™



MECCA PRO TC-9 TT TOOL KIT 113 PIECES

113
PIECES

TT
SERIES

 **Combination Lock**



		
1/3	TT1217	1/2" Socket Set 12 pt TT1 17 Pieces
1/3	TT1236	Combination Spanner Set TT1 12 Pieces
1/3	TT440-T	Plier Set TPR Grip TT1 4 Pieces
2/3	TT917N	Screwdriver Set Mixed TT1 7 Pieces
2/3	TT917TXN	Screwdriver Set TX & TPX TT1 7 Pieces
2/3	TTHEX7	T-Handle Ball Point Hex Key Set TT1 7 Pieces
3/3	TT1435	1/4" Socket Set 6 pt TT1 35 Pieces
3/3	TT3819	3/8" Socket Set 6 pt TT1 19 Pieces
3/3	TT1205	1/2" Ratchet & Accessories Set TT1 5 Pieces



SC01

£1,216.00

MECCA PRO™



MECCA PRO TC-9 TT TOOL KIT 232 PIECES

232
PIECES

TT
SERIES

 **Combination Lock**



		
1/3	TT440	Plier Set Vinyl Grip TT1 4 Pieces
1/3	TTM16	Mini Pliers & Screwdriver Set TT1 16 Pieces
1/3	TTCP121	Crimping Plier Set TT1 121 Pieces
2/3	TTM03	Inspection Set TT1 3 Pieces
2/3	TTNF12	Needle File Set TT1 12 Pieces
2/3	TTDB28	Drill Bit Set 1.0-13.0 mm TT2 28 Pieces
3/3	TT6508R	Ratcheting Spanner Set R TT1 8 Pieces
3/3	TTHT28	Ball Point Hex & TX Key Set TT1 28 Pieces
3/3	TTMD12D	Screwdriver Blade Set Mixed TT1 12 Pieces



SC02

£1,419.00



MECCA PRO™

MECCA PRO TC-9 TT TOOL KIT 193 PIECES

293 PIECES **TT** SERIES **COMBINATION** Lock



MECCA PRO™

MECCA PRO TC-9 TT TOOL KIT 100 PIECES

100 PIECES **TT** SERIES **COMBINATION** Lock



Icon	Part Number	Description
	TT440	Plier Set Vinyl Grip TT1 4 Pieces
	TTM116	Mini Pliers & Screwdriver Set TT1 16 Pieces
	TTMD12D	Screwdriver Blade Set Mixed TT1 12 Pieces
	TT917N	Screwdriver Set Mixed TT1 7 Pieces
	TT917TXN	Screwdriver Set TX & TPX TT1 7 Pieces
	TTMD74	Ratcheting Screwdriver Bit Set TT1 74 Pieces
	TT1435	1/4" Socket Set 6 pt TT1 35 Pieces
	TTBS35	1/4" & 3/8" Bit Socket Set TT1 35 Pieces
	TTTM03	Inspection Set TT1 3 Pieces



SC03

£1,196.00

Icon	Part Number	Description
	TT1236	Combination Spanner Set TT1 12 Pieces
	TT917N	Screwdriver Set Mixed TT1 7 Pieces
	TT440-T	Plier Set TPR Grip TT1 4 Pieces
	SCPS01	General Tool Set BP TT3 6 Pieces
	TT1435	1/4" Socket Set 6 pt TT1 35 Pieces
	TT3819	3/8" Socket Set 6 pt TT1 19 Pieces
	TT1218	1/2" Socket Set 12 pt TT1 17 Pieces



SC04

£1,206.00

MECCA PRO™

MECCA PRO TC-9 TT TOOL KIT E 100 PIECES

100
PIECES

TT
SERIES

Combination Lock



Icon	Icon	
1/3	TT1236	Combination Spanner Set TT1 12 Pieces
1/3	TT917N	Screwdriver Set Mixed TT1 7 Pieces
1/3	TT440-T	Plier Set TPR Grip TT1 4 Pieces
2/3	SCPS01E	General Tool Set E TT3 6 Pieces
3/3	TT1435	1/4" Socket Set 6 pt TT1 35 Pieces
3/3	TT3819	3/8" Socket Set 6 pt TT1 19 Pieces
3/3	TT1218	1/2" Socket Set 12 pt TT1 17 Pieces



SC04E

£1,206.00

MECCA PRO™

MECCA PRO TC-6T TT TOOL KIT 114 PIECES

114
PIECES

TT
SERIES

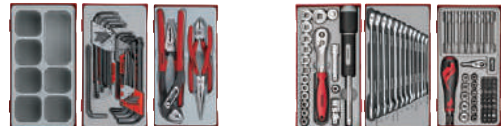

Icon	Icon	
1/2	TT01	Storage Tray TT1 7 Compartments
1/2	TT440	Plier Set Vinyl Grip TT1 4 Pieces
1/2	TTHT28	Ball Point Hex & TX Key Set TT1 28 Pieces
2/2	TT3819	3/8" Socket Set 6 pt TT1 19 Pieces
2/2	TT1236	Combination Spanner Set TT1 12 Pieces
2/2	TTMDQ49	Bits Driver Set TT1 49 Pieces



TC-6T01

£637.90



MECCA PRO™

MECCA PRO TC-6T TT MECHANICS TOOL KIT 37 PIECES

37
PIECES

TT
SERIES



Icon	Part Number	Description
	TTV440	Insulated Plier Set TT1 4 Pieces
	TTVSD09	Insulated Torque Screwdriver Blade Set TT1
	TTV3814	Insulated Socket Set 3/8" Drive TT1
	TTDV910N	Insulated Screwdriver Set Mixed TT2
	TT04	Storage Tray TT1 6 Compartments



TC-6T02

£832.90

TT SERIES TOOL TRAYS

A FLEXIBLE TOOL CONTROL SYSTEM WITH OVER 240 TOOL SETS

The TT Series offers a space-saving tool control system allowing you to fit more tools in each drawer. With our wide assortment you can build some of the largest tool kits in the market, with over 1000 tools in a 26" wide stack. The tool trays are made of recyclable plastic that is easy to clean and they are ideal for use in dirty or high moisture environments.

1 CHOOSE YOUR STORAGE

Storages for all needs.



2 CHOOSE YOUR TOOL SETS

Your kit. Your way.



3 ORGANISE YOUR KIT

Optimise your workflow.



TT
SERIES
SIZE



Portable
Service case



26" Top & Middle
box drawer



26" cabinet
drawer



37" cabinet
drawer

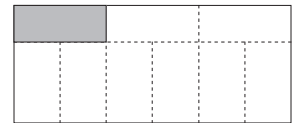
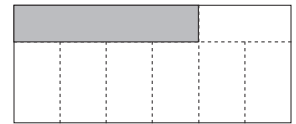
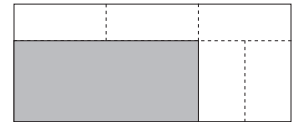
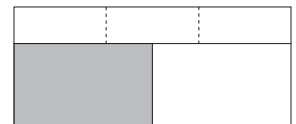
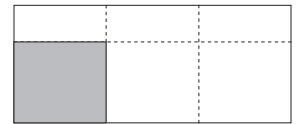
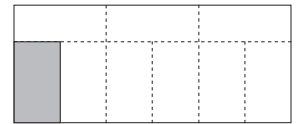
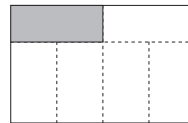
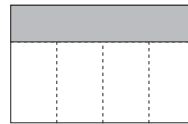
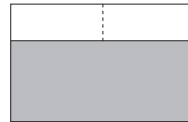
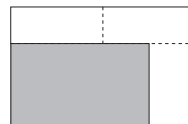
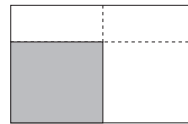
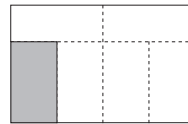
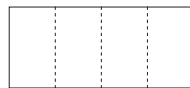
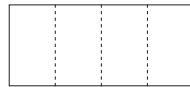
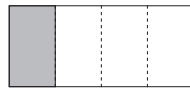
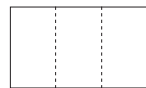
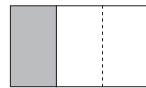
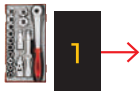



BIT SET WITH BELT CLIP MIXED 29 PIECES



- » 1/4" Mini Bits Ratchet
- » 1/4" Magnetic Bit Holder 50 mm
- » 1/4" Flat Bits 25 mm
- » 0.6×3.5, 1.0×5.5, 1.6×8.0
- » 1/4" Hex Bits 25 mm
- » 2, 3, 4, 5, 6, 8
- » 1/4" PH Bits 25 mm
- » PH1, PH2, PH3
- » 1/4" PZ Bits 25 mm
- » PZ1, PZ2, PZ3
- » 1/4" ROB Bits 25 mm
- » 1, 2, 3
- » 1/4" TPX Bits 25 mm
- » TPX20, TPX25, TPX30
- » 1/4" TX Bits 25 mm
- » TX10, TX15, TX20, TX25, TX30, TX40

TJ1429	261 g	£66.50



IMPACT NUT SETTER SET WITH BELT CLIP 5 PIECES

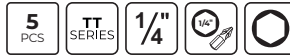

	» 1/4, 7, 8, 10, 13	
TJNS05	237 g	£48.80



IMPACT BIT SET WITH BELT CLIP MIXED 29 PIECES



- » 1/4" PH G Impact Bits 30 mm PH2G
- » 1/4" Hex Impact Bits 30 mm
- » 3, 4, 5, 6
- » 1/4" Magnetic Impact Bit Holder 60 mm
- » 1/4" PH Impact Bits 30 mm
- » PH1, PH2, PH3
- » 1/4" PZ Impact Bits 30 mm
- » PZ1, PZ2, PZ3
- » 1/4" Quick Chuck Impact Bit Holder 60 mm
- » 1/4" ROB Impact Bits 30 mm
- » 1, 2
- » 1/4" TX Impact Bits 30 mm
- » TX10, TX15, TX20, TX25, TX27, TX30, TX40

TJ1430	243 g	£67.50



BIT SET WITH BELT CLIP MIXED 28 PIECES

28 PCS TT SERIES 1/4"

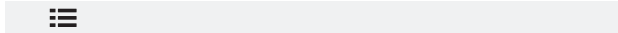

- » 1/4" Quick Chuck Bit Holder 50 mm
- » 1/4" Flat Bits 25 mm
 - » 0.6×4.5, 0.8×5.5, 1.2×6.5
- » 1/4" PH G Bits 25 mm PH2G x2
- » 1/4" Hex Bits 25 mm
 - » 4, 5, 6
- » Hex Socket Adaptor 1/4" Hex - 1/4" 25 mm
- » 1/4" PH Bits 25 mm
 - » PH1, PH2, PH3
- » 1/4" PZ Bits 25 mm
 - » PZ1, PZ2, PZ3
- » 1/4" ROB Bits 25 mm
 - » 1, 2, 3
- » 1/4" TPX Bits 25 mm
 - » TPX20, TPX25, TPX30
- » 1/4" TX Bits 25 mm
 - » TX10, TX15, TX20, TX25, TX30, TX40

TJ028	242 g	£47.20



HOOK & PICK SET WITH BELT CLIP 4 PIECES

4 PCS TT SERIES

TJ149	108 g	£25.50



TWIST EXTRACTOR SET 8-13 MM 5 PIECE

5 PCS TT SERIES 1/4" Mac

»	8, 10, 11, 12, 13

TJEP05	232 g	





SCREW EXTRACTOR SET WITH BELT CLIP 5 PIECES

5 PCS TT SERIES

»	1, 2, 3, 4, 5
TJSE055	187 g £30.20



1/4" SOCKET SET 6 PT WITH BELT CLIP 20 PIECES

20 PCS TT SERIES mm crv 1/4" 6

»	1/4" Mini Bits Ratchet
»	1/4" Magnetic Bit Holder 50 mm
»	1/4" Flat Bits 25 mm
»	0.6×4.5, 0.8×5.5, 1.2×6.5
»	Hex Socket Adaptor 1/4" Hex - 1/4" 25 mm
»	1/4" Socket 6 pt Metric
»	5.5, 6, 7, 8, 9, 10, 13
»	1/4" PH Bits 25 mm
»	PH1, PH2
»	1/4" PZ Bits 25 mm
»	PZ1, PZ2
»	1/4" TX Bits 25 mm
»	TX10, TX15, TX20
TJ1420	271 g £65.20



1/4" SOCKET SET 6 PT WITH BELT CLIP 19 PIECES

19 PCS TT SERIES mm crv 1/4" 6

»	1/4" Mini Bits Ratchet
»	1/4" Magnetic Bit Holder 50 mm
»	1/4" Flat Bits 25 mm
»	0.6×4.5, 0.8×5.5, 1.2×6.5
»	1/4" Hex Bits 25 mm
»	4, 5, 6
»	Hex Socket Adaptor 1/4" Hex - 1/4" 25 mm
»	1/4" Socket 6 pt Metric
»	8, 9, 10, 11, 12, 13
»	1/4" PH Bits 25 mm
»	PH1, PH2
»	1/4" PZ Bits 25 mm
»	PZ1, PZ2
TJ1419	275 g £62.80



STORAGE TRAY FOR TJ SETS TTI

TT SERIES SIZE 1

TTTJ04	233 g £16.20



CLIP RAIL SET TT1 32 PIECES



- » Socket Clips 10 × 1/2"
- » Socket Clips 10 × 1/4"
- » Socket Clips 10 × 3/8"



TTALU 143 g £27.90



STORAGE TRAY TT1 7 COMPARTMENTS



TT01 259 g £18.30



STORAGE TRAY WITH TOOL HOLDER TT1



TT00 233 g £18.30



STORAGE TRAY TT1 2 COMPARTMENTS



TT02 256 g £18.30





STORAGE TRAY TT1 4 COMPARTMENTS



TT03

253 g

£18.30



STORAGE TRAY TT2 4 COMPARTMENTS



TTD00

479 g

£28.90



STORAGE TRAY TT1 6 COMPARTMENTS



TT04

256 g

£18.30



STORAGE TRAY TT2 8 COMPARTMENTS



TTD01

476 g

£28.90



STORAGE TRAY TT2 16 COMPARTMENTS



TTD02

485 g

£28.90

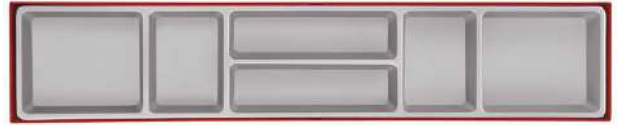

STORAGE TRAY TTX4 6 COMPARTMENTS



TTX01

378 g

£20.90

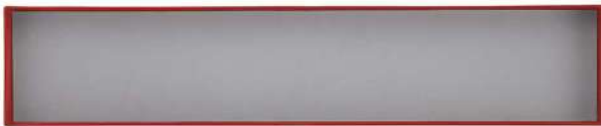

STORAGE TRAY TTX4 1 COMPARTMENT



TTX00

240 g

£17.70



STORAGE TRAY TTX4 4 COMPARTMENTS



TTX02

378 g

£20.90



TT SERIES | Tool Trays



STORAGE TRAY TTX4 8 COMPARTMENTS



TTX03

361 g

£20.40



STORAGE TRAY TTX2 6 COMPARTMENTS



TTZ01

206 g

£18.50



GENERAL TOOL SET BP TT4 9 PIECES



- » Adjustable Wrench 150 mm
- » Adjustable Wrench 250 mm
- » Curved Jaw Power Grip Plier 235 mm
- » Hacksaw 24TPI Metal
- » Utility Knife
- » Ball Pein Hammer 24oz
- » Soft Face Hammer
- » Measuring Tape Metric/Inch 3m
- » Steel Rule mm/AF 200 mm



TTPS09

3935 g

£228.90



GENERAL TOOL SET BP TT3 6 PIECES



- » Adjustable Wrench 200 mm
- » Curved Jaw Power Grip Plier 235 mm
- » Hacksaw 24TPI Metal
- » Quick Action Utility Knife
- » Ball Pein Hammer 16oz
- » Measuring Tape Metric/Inch 3m



SCPS01

2355 g

£148.90



GENERAL TOOL SET E TT4 9 PIECES

9 PCS TT SERIES SIZE 4

- » Adjustable Wrench 150 mm
- » Adjustable Wrench 250 mm
- » Curved Jaw Power Grip Plier 235 mm
- » Hacksaw 24TPI Metal
- » Utility Knife
- » Engineers Hammer 800g
- » Soft Face Hammer
- » Measuring Tape Metric/Inch 3m
- » Steel Rule mm/AF 200 mm



TTPS09E 4028 g £225.90



LONG ARM RATCHET SET TTX4 3 PIECES

3 PCS TT SERIES SIZE x4 1/4" 3/8" 1/2" DIN 3122D

- » 1/4" Ratchet Long Arm 43 Teeth 200 mm
- » 3/8" Ratchet Long Arm 41 Teeth 300 mm
- » 1/2" Ratchet Long Arm 45 Teeth 400 mm



TTXRL03 1063 g £141.90



FLEX HANDLE SET TTX4 3 PIECES

3 PCS TT SERIES SIZE x4 1/4" 3/8" 1/2"

- » 1/4" Flex Handle 200 mm
- » 3/8" Flex Handle 300 mm
- » 1/2" Flex Handle 400 mm



TTXBR03 1435 g £146.90



GENERAL TOOL SET E TT3 6 PIECES

6 PCS TT SERIES SIZE 3

- » Adjustable Wrench 200 mm
- » Curved Jaw Power Grip Plier 235 mm
- » Hacksaw 24TPI Metal
- » Quick Action Utility Knife
- » Engineers Hammer 500g
- » Measuring Tape Metric/Inch 3m



SCPS01E 2608 g £147.90





LONG ARM RATCHET FLEX HEAD SET TTX4 3 PIECES



- » 1/4" Long Ratchet Flexible Head 43 Teeth 200 mm
- » 3/8" Long Ratchet Flexible Head 41 Teeth 300 mm
- » 1/2" Long Ratchet Flexible Head 45 Teeth 400 mm



TTXRF03

1830 g

£163.90



1/4" SOCKET SET 6 PT TTI 35 PIECES

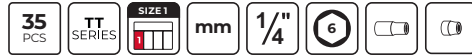

- » 1/4" Ratchet 72 Teeth IP5X
- » 1/4" Flat Bits 25 mm
- » 0.8x4.0, 0.8x5.5
- » 1/4" Hex Bits 25 mm
- » 5, 6
- » 1/4" Spinner Handle
- » 1/4" Extension Bar 50 mm
- » 1/4" Extension Bar 100 mm
- » 1/4" Universal Joint
- » 1/4" Bit Adaptor Hex Bit Coupler
- » 1/4" Socket 6 pt Metric
- » 4, 5, 5.5, 6, 7, 8, 9, 10, 11, 12, 13
- » 1/4" Deep Socket 6 pt Metric
- » 6, 7, 8, 10, 12, 13
- » 3/8" Drive Adaptor 3/8"F:1/4"M with 1/4" hole
- » 1/4" PH Bits 25 mm
- » PH1, PH2
- » 1/4" PZ Bits 25 mm
- » PZ1, PZ2
- » 1/4" TPX Bits 25 mm
- » TPX10, TPX15, TPX20



TTI435

1038 g

£107.90



1/4" SOCKET SET 12 PT TTI 35 PIECES

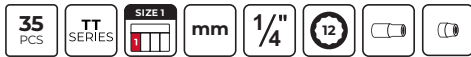

- » 1/4" Ratchet 72 Teeth IP5X
- » 1/4" Flat Bits 25 mm
 - » 0.8x4.0, 0.8x5.5
- » 1/4" Hex Bits 25 mm
 - » 5, 6
- » 1/4" Spinner Handle
- » 1/4" Extension Bar 50 mm
- » 1/4" Extension Bar 100 mm
- » 1/4" Universal Joint
- » 1/4" Bit Adaptor Hex Bit Coupler
- » 1/4" Socket 12 pt Metric
 - » 4, 5, 5.5, 6, 7, 8, 9, 10, 11, 12, 13
- » 1/4" Deep Socket 12 pt Metric
 - » 6, 7, 8, 10, 12, 13
- » 3/8" Drive Adaptor 3/8"F:1/4"M with 1/4" hole
- » 1/4" PH Bits 25 mm
 - » PH1, PH2
- » 1/4" PZ Bits 25 mm
 - » PZ1, PZ2
- » 1/4" TPX Bits 25 mm
 - » TPX10, TPX15, TPX20

TT143512	1038 g
	£107.90

1/4" & 3/8" SOCKET SET AF 6 PT TTI 32 PIECES

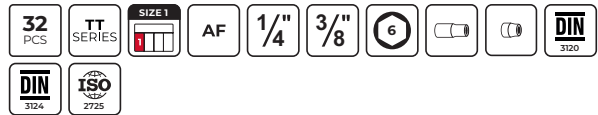

- » 1/4" Socket 6 pt AF
 - » 3/16, 7/32, 1/4, 9/32, 5/16, 11/32, 3/8, 7/16, 1/2
- » 1/4" Deep Socket 6 pt AF
 - » 3/16, 7/32, 1/4, 9/32, 5/16, 11/32, 3/8, 7/16, 1/2
- » 3/8" Socket 6 pt AF
 - » 3/8, 7/16, 1/2, 9/16, 5/8, 11/16, 3/4
- » 3/8" Deep Socket 6 pt AF
 - » 3/8, 7/16, 1/2, 9/16, 5/8, 11/16, 3/4

TTAF32	1422 g
	£98.90





1/4" & 3/8" SOCKET SET 12 PT AF TTI 32 PIECES

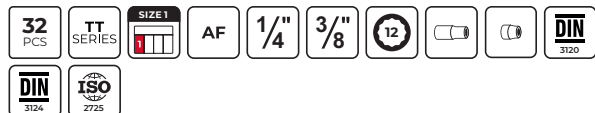

- » 1/4" Socket 12 pt AF
 - » 3/16, 7/32, 1/4, 9/32, 5/16, 11/32, 3/8, 7/16, 1/2
- » 1/4" Deep Socket 12 pt AF
 - » 3/16, 7/32, 1/4, 9/32, 5/16, 11/32, 3/8, 7/16, 1/2
- » 3/8" Socket 12 pt AF
 - » 3/8, 7/16, 1/2, 9/16, 5/8, 11/16, 3/4
- » 3/8" Deep Socket 12 pt AF
 - » 3/8, 7/16, 1/2, 9/16, 5/8, 11/16, 3/4

TTAF3212	1422 g		£99.90

1/4" SOCKET & BITS SET TTI 48 PIECES

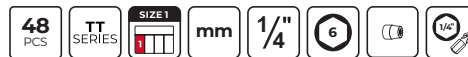

- » 1/4" Flat Bits 25 mm
 - » 0.6×3.5, 1.0×5.5, 1.6×8.0
- » 1/4" Flat Bits 89 mm
 - » 0.5×3.0, 0.8×4.0
- » 1/4" Hex Bits 25 mm
 - » 2, 3, 4, 5, 6, 8
- » 1/4" Extension Bar 75 mm
- » 1/4" Socket 6 pt Metric
 - » 5, 5.5, 6, 7, 8, 9, 10, 11, 12, 13
- » 1/4" PH Bits 25 mm
 - » PH1, PH2, PH3
- » 1/4" PH Bits 89 mm
 - » PH1, PH2
- » 1/4" Gearless Palm Ratchet
- » 1/4" PZ Bits 25 mm
 - » PZ1, PZ2, PZ3
- » 1/4" PZ Bits 89 mm
 - » PZ1, PZ2
- » 1/4" ROB Bits 25 mm
 - » 1, 2, 3
- » 1/4" TPX Bits 25 mm
 - » TPX20, TPX25, TPX30
- » 1/4" TX Bits 25 mm
 - » TX10, TX15, TX20, TX25, TX30, TX40
- » 1/4" TX Bits 89 mm
 - » TX10, TX20, TX25

TT1448	802 g	£101.90



3/8" SOCKET SET 6 PT TTI 19 PIECES



- » 3/8" Ratchet 72 Teeth IP5X
- » Reducing Adaptor 1/2"F - 3/8"M
- » 3/8" Wobble Extension Bar 75 mm
- » 3/8" Universal Joint
- » 3/8" Bit Adaptor Hex bit coupler 1/4" Hex
- » 3/8" Socket 6 pt Metric
 - » 8, 9, 10, 11, 12, 13, 14, 15, 16, 17, 18, 19, 22
- » 3/8" Rotating Spinner Handle



TT3819 1508 g £124.90



3/8" SOCKET SET 12 PT TTI 19 PIECES



- » 3/8" Ratchet 72 Teeth IP5X
- » Reducing Adaptor 1/2"F - 3/8"M
- » 3/8" Wobble Extension Bar 75 mm
- » 3/8" Universal Joint
- » 3/8" Bit Adaptor Hex bit coupler 1/4" Hex
- » 3/8" Socket 12 pt Metric
 - » 8, 9, 10, 11, 12, 13, 14, 15, 16, 17, 18, 19, 22
- » 3/8" Rotating Spinner Handle



TT381912 1508 g £124.90



3/8" SOCKET SET 6 PT TTI 16 PIECES



- » 7, 8, 9, 10, 11, 12, 13, 14, 15, 16, 17, 18, 19, 20, 21, 22



TT3816 1611 g £80.50



3/8" SOCKET SET 12 PT TTI 16 PIECES



- » 7, 8, 9, 10, 11, 12, 13, 14, 15, 16, 17, 18, 19, 20, 21, 22



TT381612 1611 g £80.50





3/8" TX BIT SOCKET SET TTI 30 PIECES



- » 1/4" TX-E Socket
 - » E4, E5, E6, E7, E8
- » 3/8" Extension Bar 75 mm
- » 3/8" Drive Adaptor 3/8"F:1/4"M with 1/4" hole
- » 3/8" TX-E Socket
 - » E10, E12, E14, E16, E18
- » 3/8" TPX Bit Socket
 - » TPX10, TPX15, TPX20, TPX25, TPX27, TPX30, TPX40, TPX45, TPX50
- » 3/8" TX Bit Socket
 - » TX10, TX15, TX20, TX25, TX27, TX30, TX40, TX45, TX50

TTTX30	1239 g	£123.50



1/4" & 3/8" BIT SOCKET SET TTI 35 PIECES



- » Step Up Adaptor 1/4"F - 3/8"M
- » 1/4" TX Bit Socket
 - » 10, 15, 20, 25, 27, 30, 40
- » 1/4" PH Bit Socket
 - » PH0, PH1, PH2, PH3
- » 1/4" Flat Bit Socket
 - » 4, 5.5, 7
- » 1/4" PZ Bit Socket
 - » PZ1, PZ2, PZ3
- » 3/8" Drive Adaptor 3/8"F:1/4"M with 1/4" hole
- » 3/8" Hex Bit Socket AF
 - » 1/8, 5/32, 3/16, 7/32, 1/4, 5/16, 3/8
- » 3/8" Hex Bit Socket Metric
 - » 3, 4, 5, 5.5, 6, 7, 8, 10, 12

TTBS35	1194 g	£80.90



1/2" RATCHET & ACCESSORIES SET TTI 5 PIECES

5 PCS TT SERIES SIZE 1 mm 1/2"

- » 1/2" Ratchet 72 Teeth IP5X
- » 1/2" Extension Bar 125 mm
- » 1/2" Extension Bar 255 mm
- » 1/2" Universal Joint
- » Step Up Adaptor 3/8"F - 1/2"M

TT1205	1546 g	£116.20



1/2" SOCKET SET 12 PT TTI 17 PIECES

17 PCS TT SERIES SIZE 1 mm 1/2" 12

» 10, 11, 12, 13, 14, 15, 16, 17, 18, 19, 20, 21, 22, 24, 27, 30, 32

TT1217	1662 g	£85.60



1/2" SOCKET SET 12 PT TTI 11 PIECES

11 PCS TT SERIES SIZE 1 mm 1/2" 12

- » 1/2" Flex Handle 265 mm
- » 1/2" Deep Socket 12 pt Metric
- » 10, 11, 12, 13, 14, 15, 16, 17, 18, 19

TT1211	1955 g	£113.20



1/2" SOCKET SET 6 PT TTI 17 PIECES

17 PCS TT SERIES SIZE 1 mm 1/2" 6

» 10, 11, 12, 13, 14, 15, 16, 17, 18, 19, 20, 21, 22, 24, 27, 30, 32

TT1217-6	1732 g	£85.60





1/2" SOCKET SET 12 PT TTI 17 PIECES



- » 1/2" Ratchet 72 Teeth IP5X
- » 1/2" Extension Bar 63.5 mm
- » 1/2" Extension Bar 150 mm
- » 1/2" Universal Joint
- » 1/2" Socket 12 pt Metric
- » 10, 11, 12, 13, 14, 15, 16, 17, 18, 19, 22, 24
- » Step Up Adaptor 3/8"F - 1/2"M

TT1218	2018 g	£142.70



1/2" SOCKET SET 6 PT TTI 18 PIECES



- » 1/2" Ratchet 72 Teeth IP5X
- » 1/2" Extension Bar 63.5 mm
- » 1/2" Extension Bar 150 mm
- » 1/2" Universal Joint
- » 1/2" Socket 6 pt Metric
- » 10, 11, 12, 13, 14, 15, 16, 17, 18, 19, 22, 24
- » Step Up Adaptor 3/8"F - 1/2"M

TT1218-6	2046 g	£142.70



1/2" SOCKET SET 12 PT AF TTI 15 PIECES



- » 3/8, 7/16, 1/2, 9/16, 5/8, 11/16, 3/4, 13/16, 7/8, 15/16, 1, 1 1/16, 1 1/8, 1 3/16, 1 1/4

TT1215AF	1720 g	£85.20



1/2" HEX BIT SOCKET SET TTI 16 PIECES



- » 1/2" Hex Bit Socket Metric
- » 5, 6, 7, 8, 9, 10, 12, 14, 17
- » 1/2" Long Hex Bit Socket Metric
- » 5, 6, 10, 12, 14, 17
- » 1/2" Extra Long Hex Bit Socket Metric 8 mm

TTHEX16	1610 g	£116.90



1/2" HEX BIT SOCKET SET TTI 23 PIECES

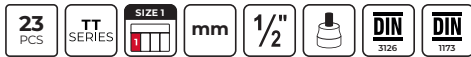

- » Hex Bits 40 mm
 - » 5, 6, 7, 8, 9, 10, 12, 14, 17, 19
- » Hex Bits 75 mm
 - » 5, 6, 7, 8, 9, 10, 12, 14, 17, 19
- » 1/2" Bit Adaptor 10 mm
- » 1/2" Bit Adaptor 12 mm
- » Hex Mini Screwdriver 2

TTHex23 1475 g £87.90



1/2" TX BIT SOCKET SET TTI 23 PIECES



- » TX Bits 40 mm
 - » TX20, TX25, TX27, TX30, TX40, TX45, TX50, TX55, TX60, TX70
- » TX Bits 75 mm
 - » TX20, TX25, TX27, TX30, TX40, TX45, TX50, TX55, TX60, TX70
- » 1/2" Bit Adaptor 10 mm
- » 1/2" Bit Adaptor 12 mm
- » Hex Mini Screwdriver 2

TTTX23 1160 g £87.90



1/2" TX BIT SOCKET SET TTI 18 PIECES



- » 1/2" TX Bit Socket
 - » TX20, TX25, TX27, TX30, TX40, TX45, TX50, TX55, TX60
- » 1/2" Long TX Bit Socket
 - » TX20, TX25, TX27, TX30, TX40, TX45, TX50, TX55, TX60

TTTX18 1512 g £120.50



1/2" LONG HEX & TX BIT SOCKET SET TTI 15 PIECES



- » 1/2" Long TX Bit Socket
 - » TX20, TX25, TX27, TX30, TX40, TX45, TX50, TX55, TX60
- » 1/2" Long Hex Bit Socket Metric
 - » 5, 6, 7, 8, 10, 12

TTTX15 1482 g £118.90





**1/2" LONG RIBE® & XZN/TRIPLE SQUARE BIT SOCKET SET
TTI 15 PIECES**



- » 1/2" Long Ribe® Bit Socket
4, 5, 6, 8, 10, 11, 12, 13
- » 1/2" Long XZN/Triple Square Bit Socket
5, 6, 8, 10, 12, 14, 16



TTRS15

1689 g

£124.90



EXTENSION BARS SET TTX4 13 PIECES



- » 1/2" Wobble Extension Bar 75 mm
- » 1/2" Extension Bar 500 mm
- » 1/2" Universal Joint
- » 1/4" Extension Bar 150 mm
- » 1/4" Extension Bar 305 mm
- » 1/4" Universal Joint
- » 3/8" Wobble Extension Bar 75 mm
- » 3/8" Extension Bar 500 mm
- » 3/8" Universal Joint
- » 3/8" Drive Adaptor 3/8"F:1/4"M with 1/4" hole
- » Hex Mini Screwdriver
2, 2.5
- » T Bar Handle Grip



TTXEXT13

2088 g

£149.90



3/4" RATCHET & ACCESSORIES SET TTX4 4 PIECES

4 PCS TT SERIES SIZE x4 3/4"

- » 3/4" Ratchet Heavy Duty 72 Teeth
- » 3/4" Extension Bar 200 mm
- » 3/4" Extension Bar 400 mm
- » 3/4" Sliding T Bar

TTX3404	6063 g	£312.90



3/4" RATCHET & ACCESSORIES SET TTX4 2 PIECES

2 PCS TT SERIES SIZE x4 3/4" DIN 3122 DIN 3122D

- » 3/4" Extendable Ratchet 72 Teeth 545-860 mm

TTX3402E	4766 g	£329.90



3/4" SOCKET SET 6 PT TTX4 14 PIECES

14 PCS TT SERIES SIZE x4 mm 3/4" 6 DIN 3120 DIN 3124

- » 19, 21, 22, 24, 27, 30, 32, 33, 34, 36, 38, 41, 46, 50

TTX3414	5463 g	£210.90



3/4" SOCKET SET 12 PT AF TTX4 14 PIECES

15 PCS TT SERIES SIZE x4 AF 3/4" 12 DIN 3120

- » 7/8, 15/16, 1, 1 1/16, 1 1/8, 1 3/16, 1 1/4, 1 5/16, 1 3/8, 1 7/16, 1 1/2, 1 5/8, 1 3/4, 1 7/8

TTX34AF	5072 g	£216.90





SOCKET ADAPTOR SET TTI 17 PIECES



- » 1/4" Quick Chuck Bit Holder 50 mm
- » 1/4" Magnetic Bit Holder 50 mm
- » 1/4" Magnetic Bit Holder 70 mm
- » 1/4" Hex drive impact socket adaptor for 1/2" sockets
- » 1/4" Hex drive impact socket adaptor for 1/4" sockets
- » 1/4" Hex drive impact socket adaptor for 3/8" sockets
- » Reducing Adaptor 1/2"F - 3/8"M
- » Step Up Adaptor 1/2"F - 3/4"M
- » Step Up Adaptor 1/4"F - 3/8"M
- » Hex Socket Adaptor 1/4" Hex - 1/4" 25 mm
- » 1/4" Bit Adaptor Hex Bit Coupler
- » Step Up Adaptor 3/4"F - 1"M
- » Reducing Adaptor 3/4"F - 1/2"M
- » 3/8" Drive Adaptor 3/8"F:1/4"M with 1/4" hole
- » Step Up Adaptor 3/8"F - 1/2"M
- » Hex Socket Adaptor 1/4" Hex - 3/8" 32 mm
- » 3/8" Bit Adaptor Hex bit coupler 1/4" Hex



TTADP17

1286 g

£113.90



1/4" & 3/8" IMPACT SOCKET SET ANSI TTI 24 PIECES



- » 1/4" Impact Socket ANSI Metric
6, 7, 8, 10, 13
- » Impact Reducing Adaptor 3/8"F - 1/4"M DIN
- » 3/8" Impact Socket ANSI Metric
8, 10, 11, 12, 13, 14, 16, 17, 19
- » 3/8" Deep Impact Socket ANSI Metric
8, 10, 11, 12, 13, 14, 16, 17, 19



TT9024

1792 g

£112.90



1/2" IMPACT SOCKET ACCESSORIES SET DIN TTI 11 PIECES



- » 1/2" Impact Extension Bar DIN 75 mm
- » 1/2" Impact Extension Bar DIN 125 mm
- » 1/2" Impact Extension Bar DIN 250 mm
- » 1/2" Impact Universal Joint DIN
- » Impact Reducing Adaptor 1/2"F (DIN) - 3/8"M (ANSI)
- » Impact Step Up Adaptor 1/2"F - 3/4"M DIN
- » Impact Step Up Adaptor 3/8"F - 1/2"M DIN
- » Retaining Ring
 - » 19x4, 24x4
- » Retaining Pin
 - » 3x20, 3x25



TT9207

1323 g

£117.90

1/2" IMPACT SOCKET ACCESSORIES SET ANSI TTI 11 PIECES



- » 1/2" Impact Extension Bar DIN (F) ANSI (M) 75 mm
- » 1/2" Impact Extension Bar DIN (F) ANSI (M) 125 mm
- » 1/2" Impact Extension Bar DIN (F) ANSI (M) 250 mm
- » 1/2" Impact Universal Joint DIN (F) ANSI (M)
- » Impact Reducing Adaptor 1/2"F (DIN) - 3/8"M (ANSI)
- » Impact Step Up Adaptor 1/2"F (DIN) - 3/4"M (ANSI)
- » Impact Step Up Adaptor 3/8"F (DIN) - 1/2"M (ANSI)
- » Retaining Ring
 - » 19x4, 24x4
- » Retaining Pin
 - » 3x20, 3x25



TT9207A

1554 g

£117.90





1/2" IMPACT SOCKET SET ANSI TTI 16 PIECES



- » 1/2" Impact Socket ANSI Metric
13, 15, 16, 17, 18, 19, 22, 24
- » 1/2" Deep Impact Socket ANSI Metric
13, 15, 16, 17, 18, 19, 22, 24



TT9116N

3020 g

£137.90



1/2" IMPACT SOCKET SET DIN TTI 20 PIECES



- » 1/2" Impact Socket DIN Metric
13, 15, 16, 17, 18, 19, 22, 24
- » 1/2" Deep Impact Socket DIN Metric
13, 15, 16, 17, 18, 19, 22, 24
- » Retaining Ring
19×4, 24×4
- » Retaining Pin
3×20, 3×25



TT9120DN

3244 g

£174.90



1/2" IMPACT SOCKET SET DIN TTI 12 PIECES



- » 1/2" Impact Socket DIN Metric
19, 21, 22, 24, 27, 30, 32
- » 1/2" Deep Impact Socket DIN Metric
19, 21, 22, 24, 27
- » Retaining Ring 24 × 4.0 mm
- » Retaining Pin 3 × 25 mm



TT9212

3066 g

£161.90



1/2" TX IMPACT SOCKET SET DIN TTI 12 PIECES

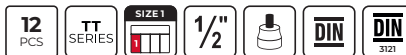

- » TX10, TX15, TX20, TX25, TX27, TX30, TX40, TX45, TX50, TX55, TX60, TX70



TT9212TX

1350 g

£205.90



1/2" TORQUE STICKS & WHEEL NUT SET TTI 8 PIECES

8 PCS TT SERIES SIZE 1 1/2" DIN

- » 1/2" Impact Socket Wheel Nut 17, 19, 21
- » 1/2" Torque Stick 90Nm
- » 1/2" Torque Stick 110Nm
- » 1/2" Torque Stick 120Nm
- » 1/2" Torque Stick 140Nm
- » Impact Step Up Adaptor 3/8"F - 1/2"M DIN

TTTS08 1989 g £170.90



3/4" IMPACT SOCKET SET DIN TT2 16 PIECES

16 PCS TT SERIES SIZE 2 mm 3/4" 6

- » 3/4" Impact Extension Bar DIN 175 mm
- » 3/4" Impact Socket DIN Metric 19, 24, 27, 30, 32, 33, 34, 36, 38
- » Retaining Ring 36 x 5.0 mm
- » Retaining Pin 4 x 35 mm

TTD9416 5111 g £251.90



3/8" & 1/2" HEX IMPACT SOCKET SET DIN TTI 15 PIECES

15 PCS TT SERIES SIZE 1 3/8" 1/2" DIN 3129

- » 1/2" Hex Impact Socket DIN Metric 5, 6, 8, 10, 12, 14, 17, 19
- » 3/8" Hex Bit Impact Socket DIN Metric 4, 5, 6, 7, 8, 10, 12

TT9015HX 1658 g £233.90



3/4" IMPACT SOCKET SET DIN TTX4 15 PIECES

15 PCS TT SERIES SIZE x4 mm 3/4" 6

- » 3/4" Impact Socket DIN Metric 19, 24, 27, 28, 30, 32, 34, 36
- » 3/4" Deep Impact Socket DIN Metric 19, 24, 27, 30, 32, 33, 36

TTX9415 8963 g £398.90





1/2" IMPACT DRIVER SET TT1 20 PIECES



- » 5/16" Hex Impact Driver Bits
 - » 4, 5, 6, 8
- » 1/2" Impact Coupler Adaptor 5/16" Hex
- » 5/16" PH Impact Driver Bits
 - » PH1, PH2, PH3, PH4
- » 5/16" Flat Impact Driver Bits
 - » 6, 8, 10, 12
- » 5/16" TX Impact Driver Bits
 - » TX30, TX40, TX45, TX50, TX55
- » Hex Socket Adaptor 5/16" Hex - 3/8"
- » 1/2" Impact Driver Heavy Duty



TTID20

1225 g

£56.90



1/4" IMPACT DRIVER SET TT1 19 PIECES



- » 1/4" Impact Socket ANSI Metric
 - » 8, 10, 13
- » 1/4" Hex Impact Bits 50 mm
 - » 3, 4, 5, 6
- » 1/4" Impact Bit Adaptor 1/4" Hex
- » 1/4" Impact Driver
- » 1/4" PH Impact Bits 50 mm
 - » PH2, PH3
- » 1/4" PZ Impact Bits 50 mm
 - » PZ2, PZ3
- » 1/4" Screw Extractor
 - » 1, 2, 3
- » 1/4" TX Impact Bits 50 mm
 - » TX25, TX30, TX40



TTID19

721 g

£61.20



TORQUE SCREWDRIVER SET TTI 38 PIECES



☰

- » 1/4" Torque Screwdriver 1-5Nm
- » 1/4" Flat Bits 25 mm
 - » 0.5 x 3.0, 0.6 x 4.5, 0.8 x 5.5, 1.2 x 6.5
- » 1/4" PH G Bits 25 mm PH2G
- » 1/4" Hex Bits 25 mm
 - » 2, 3, 4, 5, 6
- » Hex Socket Adaptor 1/4" Hex - 1/4" 30 mm
- » 1/4" PH Bits 25 mm
 - » PH1, PH2, PH3 (*2)
- » 1/4" PZ Bits 25 mm
 - » PZ1, PZ2, PZ3 (*2)
- » 1/4" ROB Bits 25 mm
 - » 1, 2, 3
- » 1/4" TPX Bits 25 mm
 - » TPX10, TPX15, TPX20, TPX30, TPX40
- » 1/4" TX Bits 25 mm
 - » TX8, TX9, TX10, TX15, TX20, TX25, TX27, TX30, TX40



TTSD38

650 g

£151.90





3/8" TORQUE WRENCH SET 20-110 NM TTX4 22 PIECES



- » TX Bits 40 mm
TX08, TX10, TX15, TX20, TX25, TX27, TX30, TX40
- » 3/8" Torque Wrench 20 - 110Nm
- » 3/8" Extension Bar 75 mm
- » 3/8" Extension Bar 125 mm
- » 3/8" Bit Adaptor Hex bit coupler 10 mm Hex
- » 3/8" Crow Foot Wrench
10, 11, 12, 13, 14, 15, 16, 17, 18, 19



TTX3892 2166 g £241.90



1/2" TORQUE WRENCH & BREAKER BAR SET TTX4



- » 1/2" Torque Wrench 40 - 210Nm
- » 1/2" Breaker Bar 17"



TTX2493 2652 g £159.90



1/2" TORQUE WRENCH P-SERIES 40-200 NM TTX4



- » 1/2" Torque Wrench P-Series 40-200 Nm TTX4
- » 1/2" Torque Wrench Plus 40 - 200Nm



TTXP1292 1588 g £211.90



COMBINATION SPANNER SET ANTI SLIP TT1 12 PIECES



- » 8, 9, 10, 11, 12, 13, 14, 15, 16, 17, 18, 19



TT8012 1288 g £135.90



STUBBY COMBINATION SPANNER SET TT1 10 PIECES



» 10, 11, 12, 13, 14, 15, 16, 17, 18, 19

TT6010M 1035 g £102.90



COMBINATION SPANNER SET AF TT1 8 PIECES



» 5/16, 3/8, 7/16, 1/2, 9/16, 5/8, 11/16, 3/4

TT3592 932 g £85.50



COMBINATION SPANNER SET TT1 12 PIECES



» 8, 9, 10, 11, 12, 13, 14, 15, 16, 17, 18, 19

TT1236 1250 g £92.90



COMBINATION SPANNER SET TTX4 7 PIECES



» 20, 21, 22, 24, 27, 30, 32

TTX2032 2631 g £156.90





COMBINATION SPANNER SET AF TTX4 7 PIECES



» 13/16, 7/8, 15/16, 1, 1 1/16, 1 1/8, 1 1/4		
TTX2640	2781 g	£156.90



RATCHETING COMBINATION SPANNER SET R TT1 8 PIECES



» 8, 10, 11, 12, 13, 14, 17, 19		
TT6508R	1119 g	£224.90



COMBINATION SPANNER SET TTX4 6 PIECES



» 24, 27, 30, 32, 34, 36		
TTX2436	3570 g	£216.50



RATCHETING COMBINATION SPANNER SET R TT1 11 PIECES



» 8, 10, 11, 12, 13, 14, 15, 16, 17, 18, 19		
TT6511R	1506 g	£299.90



RATCHETING COMBINATION SPANNER SET R AF TTI 8 PIECES

8 PCS TT SERIES SIZE 1 AF DIN 1711-1

» 5/16, 3/8, 7/16, 1/2, 9/16, 5/8, 11/16, 3/4



TT6508RAF 1163 g £249.90



STUBBY RATCHETING COMBINATION SPANNER SET TTI 10 PIECES

10 PCS TT SERIES SIZE 1 mm

» 10, 11, 12, 13, 14, 15, 16, 17, 18, 19



TT6010MRS 1137 g £221.90



RATCHETING COMBINATION SPANNER SET RF TTI 8 PIECES

8 PCS TT SERIES SIZE 1 mm

» 8, 10, 11, 12, 13, 14, 17, 19



TT6508RF 1176 g £262.90



DOUBLE RING SPANNER SET TTX4 11 PIECES

11 PCS TT SERIES SIZE x4 mm DIN 838

» 6×7, 8×9, 10×11, 12×13, 14×15, 16×17, 18×19, 20×22, 21×23, 24×27, 30×32



TTX6311 3113 g £189.90





DOUBLE OPEN ENDED SPANNER SET AF TTX4 7 PIECES



» 1/4×5/16, 3/8×7/16, 1/2×9/16, 5/8×3/4, 13/16×7/8, 15/16×1, 1 1/8×1 1/4



TTX6607

1739 g

£129.90



LONG DOUBLE RING SPANNER SET TTX4 6 PIECES



» 8×10, 11×13, 12×14, 16×18, 17×19, 22×24



TTXFLS06

1836 g

£291.90



DOUBLE RING SPANNER SET AF TTX4 7 PIECES



» 1/4×5/16, 3/8×7/16, 1/2×7/16, 13/16×7/8, 15/16×1 1/16, 1×1 1/8, 1 1/8×1 1/4



TTX6707

2584 g

£177.90



DOUBLE OPEN ENDED SPANNER SET TTI 8 PIECES



» 6×7, 8×9, 10×11, 12×13, 14×15, 16×17, 18×19, 20×22



TT6208

1101 g

£65.90



DOUBLE FLEX WRENCH SET TTI 6 PIECES



» 8×9, 10×11, 12×13, 14×15, 16×17, 18×19		
TT6506	1613 g	£168.90



HOOK & PIN WRENCH SET TTI 8 PIECES



» Hook Wrench 19 - 50 mm		
» Hook Wrench 32 - 75 mm		
» Hook Wrench 50 - 120 mm		
» Pin Arm 4 mm, 19 - 50 mm		
» Pin Arm 5 mm, 32 - 75 mm		
» Pin 6 mm, 19 - 50 mm & 32 - 75 mm		
» Pin Arm 6 mm, 50 - 120 mm		
» Pin 8 mm, 50 - 120 mm		
TTHP08	1210 g	£184.90



RATCHETING RING SPANNER SET TTI 6 PIECES



» 6×8, 7×9, 10×13, 12×14, 17×19, 21×22		
TTR0RS	1189 g	£122.90



ADJUSTABLE WRENCH SET TTI 4 PIECES



» Adjustable Wrench TPR Grip 150 mm		
» Adjustable Wrench TPR Grip 200 mm		
» Adjustable Wrench Wide Jaw 200 mm		
» Adjustable Wrench TPR Grip 250 mm		
TTADJ04	1297 g	£147.90





RATCHETING SCREWDRIVER SET TTI 15 PIECES



- » 1/4" Hex ratcheting bits driver set 13 pieces
 - » 1/4" Hex Bits 25 mm
 - » 3, 4, 5
 - » 1/4" hex bit with magnetic tip 25 mm
 - » 1/4" PH Bits 25 mm
 - » PH1, PH2
 - » 1/4" PZ Bits 25 mm
 - » PZ1, PZ2
 - » 1/4" TX Bits 25 mm
 - » TX15, TX20, TX25, TX30
 - » 1/4" bits driver extension 141 mm
 - » 1/4" bits driver extension 238 mm



TTRSD15



608 g



SCREWDRIVER SET MIXED WITH MAGNETIC CHARGER TTI 5 PIECES



- » Flat Screwdriver 1.0 × 5.5 × 75 mm M
- » PH Screwdriver
 - » PH1, PH2
- » PZ Screwdriver PZ2 × 100 mm L
- » Magnetic Screwdriver Charger



TT905N



622 g



SCREWDRIVER SET MIXED TTI 7 PIECES



- » Flat Screwdriver
 - » 0.5×3.0, 1.0×5.5, 1.2×6.5
- » PH Screwdriver
 - » PH0, PH1, PH2
- » PZ Screwdriver PZ2 × 100 mm L Hex Shaft



TT917N



728 g

£63.50



SCREWDRIVER SET MIXED TT2 14 PIECES



- » Flat Screwdriver
 - » 0.5×3.0, 0.6×3.5, 1.0×5.5 (×2), 1.2×6.5 (×2)
- » PH Screwdriver
 - » PH0, PH1, PH2 (×2)
- » PZ Screwdriver
 - » PZ0, PZ1, PZ2 (×2)



TTD914N 1014 g £119.90



SCREWDRIVER SET TX & TPX TTI 7 PIECES



- » TPX Screwdriver
 - » TPX10, TPX15, TPX20, TPX25, TPX30
- » TX Screwdriver
 - » TX8, TX9



TT917TXN 689 g £64.50



SCREWDRIVER SET FLAT & PH TTX4 8 PIECES



- » Flat Screwdriver
 - » 0.5×3.0, 1.0×5.5, 1.2×6.5 (×2), 1.2×8.0, 1.6×10.0
- » PH Screwdriver
 - » PH2, PH3



TTX918N 1252 g £94.90



SCREWDRIVER SET TX TT2 12 PIECES



- » TX6, TX7, TX8, TX9, TX10, TX15, TX20, TX25, TX27, TX30, TX40, TX45



TTD912TXN 1353 g £117.90





SCREWDRIVER BLADE SET MIXED TTI 12 PIECES



- » 0.8×4;1.0×5.5, 1.2×6.5;PH3, 3;3 Ballpoint, 4;4 Ballpoint, 5;5 Ballpoint, 6;6 Ballpoint, PH1;PH2, PZ1;PZ2, TX10;TX15, TX20;TX25, TX30;TX40



TTMD12D

824 g

£67.90



MINI PLIERS & SCREWDRIVER SET TTI 16 PIECES



- » Mini Side Cutting Plier 115 mm
- » Mini End Cutting Plier 110 mm
- » Mini Long Nose Plier 140 mm
- » Mini Flat Nose Plier 140 mm
- » Flat Mini Screwdriver
- » 2, 2.5, 3
- » PH Mini Screwdriver
- » PH00, PH0, PH1
- » TX Mini Screwdriver
- » TX6, TX7, TX8, TX9, TX10, TX15



TTM16

722 g

£141.90



POWER THROUGH SCREWDRIVER SET TTX4 5 PIECES



- » Flat Power Through Screwdriver
- » 1.2×6.5, 1.2×8, 1.6×10
- » PH Power Through Screwdriver
- » PH2, PH3



TTXMDTN

1361 g

£76.90



BITS DRIVER SET TTI 49 PIECES



- » 1/4" Flat Bits 25 mm
- » 0.6×3.5, 1.0×5.5, 1.6×8.0
- » 1/4" Flat Bits 89 mm 0.8 × 4.0 mm
- » 1/4" Hex Bits 25 mm
- » 2, 3, 4, 5, 6, 8
- » 1/4" Hex Bits 89 mm Hex 4 mm
- » Hex Socket Adaptor 1/4" Hex - 1/4" 30 mm
- » 1/4" Socket 6 pt Metric
- » 4, 5, 5.5, 6, 7, 8, 9, 10, 11, 12, 13
- » 1/4" Quick Chuck Bits Driver 147 mm
- » 1/4" PH Bits 25 mm
- » PH1, PH2, PH3
- » 1/4" PH Bits 89 mm
- » PH1, PH2
- » 1/4" PZ Bits 25 mm
- » PZ1, PZ2, PZ3
- » 1/4" PZ Bits 89 mm PZ2
- » 1/4" Ratchet Head Hex/Square Drive
- » 1/4" ROB Bits 25 mm
- » 1, 2, 3
- » 1/4" TPX Bits 25 mm
- » TPX20, TPX25, TPX30
- » 1/4" TX Bits 25 mm
- » TX10, TX15, TX20, TX25, TX30, TX40
- » 1/4" TX Bits 89 mm
- » TX20, TX25, TX30



TTMDQ49

831 g

£102.90



RATCHETING BITS DRIVER SET TTI 84 PIECES



- » 1/4" Flat Bits 25 mm
- » 0.6×3.5, 0.6×4.5, 0.8×4.0, 0.8×5.5, 1.0×5.5 (*2), 1.2×6.5, 1.4×7.0, 1.6×8.0
- » 1/4" PH G Bits 25 mm PH2G
- » 1/4" Hex Bits 25 mm
- » 2, 3, 4, 5, 6, 8
- » Hex Socket Adaptor 1/4" Hex - 1/4" 25 mm
- » Hex Socket Adaptor 1/4" Hex - 1/4" 30 mm
- » 1/4" Socket 6 pt Metric
- » 4, 5, 5.5, 6, 7, 8, 9, 10, 11, 12, 13
- » 1/4" Ratcheting Quick Chuck Bits Driver
- » 1/4" Flat Bits 25 mm
- » 1.0×5.5, 1.4×7.0
- » Hex Socket Adaptor 1/4" Hex - 1/4" 25 mm
- » 1/4" PH Bits 25 mm
- » PH1, PH2
- » 1/4" PZ Bits 25 mm
- » PZ1, PZ2
- » 1/4" PH Bits 25 mm
- » PH1 (*4), PH2 (*7), PH3
- » 1/4" PZ Bits 25 mm
- » PZ1 (*4), PZ2 (*7), PZ3
- » 1/4" ROB Bits 25 mm
- » 1, 2, 3
- » 1/4" TPX Bits 25 mm
- » TPX10, TPX15, TPX20 (*2), TPX25 (*2), TPX27, TPX30, TPX40
- » 1/4" Bits Driver Extension 150 mm Flexible
- » 1/4" TX Bits 25 mm
- » TX6, TX7, TX8, TX9, TX10, TX15, TX20 (*3), TX25 (*3), TX27, TX30, TX40



TTMDR84

947 g

£96.50





BITS DRIVER SET TTI 38 PIECES



- » 1/4" Flat Bits 25 mm
 - » 0.6×3.5, 1.0×5.5, 1.6×8.0
- » 1/4" Flat Bits 89 mm
 - » 0.5×3.0, 0.8×4.0
- » 1/4" Hex Bits 25 mm
 - » 2, 3, 4, 5, 6, 8
- » 1/4" Quick Chuck Bits Driver 147 mm
- » 1/4" Quick Chuck Bits Driver 183 mm
- » 1/4" PH Bits 25 mm
 - » PH1, PH2, PH3
- » 1/4" PH Bits 89 mm
 - » PH1, PH2
- » 1/4" PZ Bits 25 mm
 - » PZ1, PZ2, PZ3
- » 1/4" PZ Bits 89 mm
 - » PZ1, PZ2
- » 1/4" ROB Bits 25 mm
 - » 1, 2, 3
- » 1/4" TPX Bits 25 mm
 - » TPX20, TPX25, TPX30
- » 1/4" TX Bits 25 mm
 - » TX10, TX15, TX20, TX25, TX30, TX40
- » 1/4" TX Bits 89 mm
 - » TX10, TX20, TX25



TTMDQ38

740 g

£79.50

RATCHETING SCREWDRIVER BIT SET TTI 74 PIECES



- » 1/4" Flat Bits 25 mm
 - » 0.6×3.5, 0.6×4.5, 0.8×4.0, 0.8×5.5 (×3), 1.2×6.5, 1.4×7.0, 1.6×8.0
- » 1/4" PH G Bits 25 mm PH2G
- » 1/4" Hex Bits 25 mm
 - » 2, 3, 4, 5, 6, 8
- » Hex Socket Adaptor 1/4" Hex - 1/4" 25 mm
- » Hex Socket Adaptor 1/4" Hex - 1/4" 30 mm
- » 1/4" Bit Adaptor Hex Bit Coupler
- » 1/4" Ratcheting Bits Driver Set
 - » 1/4" Flat Bits 25 mm
 - » 1.0×5.5, 1.4×7.0
 - » Hex Socket Adaptor 1/4" Hex - 1/4" 25 mm
- » 1/4" PH Bits 25 mm
 - » PH1, PH2
- » 1/4" PZ Bits 25 mm
 - » PZ1, PZ2
- » 1/4" PH Bits 25 mm
 - » PH1 (×4), PH2 (×7), PH3
- » 1/4" PZ Bits 25 mm
 - » PZ1 (×4), PZ2 (×7), PZ3
- » 1/4" ROB Bits 25 mm
 - » 1, 2, 3
- » 1/4" TPX Bits 25 mm
 - » TPX10, TPX15, TPX20 (×2), TPX25 (×2), TPX27, TPX30, TPX40
- » 1/4" Bits Driver Extension 100 mm
- » 1/4" Bits Driver Extension 150 mm Flexible
- » 1/4" TX Bits 25 mm
 - » TX6, TX7, TX8, TX9, TX10, TX15, TX20 (×3), TX25 (×3), TX27, TX30, TX40



TTMD74

837 g

£76.50



ANGLED RATCHETING BITS DRIVER SET TTI 64 PIECES



- » 1/4" Flat Bits 25 mm
- » 0.6×3.5, 0.6×4.5, 0.8×4.0, 0.8×5.5, 1.0×5.5 (×2), 1.2×6.5, 1.4×7.0, 1.6×8.0
- » 1/4" PH G Bits 25 mm PH2G
- » 1/4" Hex Bits 25 mm
- » 2, 3, 4, 5, 6, 8
- » Hex Socket Adaptor 1/4" Hex - 1/4" 25 mm
- » 1/4" Socket 6 pt Metric
- » 4, 5, 5.5, 6, 7, 8, 9, 10, 11, 12, 13
- » 1/4" Ratcheting Angled Bits Driver Set
- » 1/4" Flat Bits 25 mm
- » 1.0×5.5, 1.4×7.0
- » Hex Socket Adaptor 1/4" Hex - 1/4" 25 mm
- » 1/4" PH Bits 25 mm
- » PH1, PH2
- » 1/4" PZ Bits 25 mm
- » PZ1, PZ2
- » 1/4" PH Bits 25 mm
- » PH1 (×4), PH2 (×4), PH3 (×2)
- » 1/4" PZ Bits 25 mm
- » PZ1 (×3), PZ2 (×3)
- » 1/4" ROB Bits 25 mm
- » 1, 2, 3
- » 1/4" TX Bits 25 mm
- » TX6, TX7, TX8, TX9, TX10, TX15, TX20 (×3), TX25 (×3), TX27, TX30, TX40



TTMDRT64

869 g

£99.90



SOCKET & BIT SET FLEXIBLE HANDLE TTX4 41 PIECES



- » 1/4" Flat Bits 25 mm
- » 0.8×4.0, 0.8×5.5, 1.6×8.0
- » 1/4" Hex Bits 25 mm
- » 3, 4, 5, 6, 8, 10
- » Hex Socket Adaptor 1/4" Hex - 1/4" 25 mm
- » 1/4" Socket 6 pt Metric
- » 4, 4.5, 5, 5.5, 6, 7, 8, 9, 10, 11, 12, 13
- » 1/4" Extra Long Flexible Socket Driver 555 mm
- » 1/4" Long Flexible Bits Driver
- » 1/4" PH Bits 25 mm
- » PH0, PH1, PH2, PH3 (×2)
- » 1/4" PZ Bits 25 mm
- » PZ0, PZ1, PZ2, PZ3
- » 1/4" TX Bits 25 mm
- » TX8, TX10, TX15, TX20, TX25, TX27, TX30, TX40



TTXMD41N

1206 g

£91.50





IMPACT BIT SET TTI 53 PIECES



- » 1/4" PH G Impact Bits 30 mm PH2G
- » 1/4" PH G Impact Bits 50 mm PH2G
- » 1/4" Hex Impact Bits 30 mm
 - » 3, 4 (x2), 5, 6
- » 1/4" Hex Impact Bits 50 mm
 - » 3, 4, 5, 6
- » 1/4" Magnetic Impact Bit Holder 60 mm
- » 1/4" Impact Nut Setter
 - » 1/4, 8, 10, 13
- » 1/4" PH Impact Bits 30 mm
 - » PH1, PH2 (x2), PH3
- » 1/4" PH Impact Bits 89 mm PH2
- » 1/4" PZ Impact Bits 30 mm
 - » PZ1, PZ2 (x2), PZ3
- » 1/4" PZ Impact Bits 89 mm PZ2
- » 1/4" Quick Chuck Impact Bit Holder 60 mm
- » 1/4" ROB Impact Bits 30 mm
 - » 1, 2
- » 1/4" ROB Impact Bits 50 mm
 - » 1, 2, 3
- » 1/4" TX Impact Bits 30 mm
 - » TX10, TX15, TX20 (x2), TX25 (x2), TX27, TX30 (x2), TX40
- » 1/4" TX Impact Bits 50 mm
 - » TX10, TX15, TX20, TX25, TX27, TX30, TX40
- » 1/4" TX Impact Bits 89 mm
 - » TX20, TX25, TX30

TTBS53	416 g	£139.90

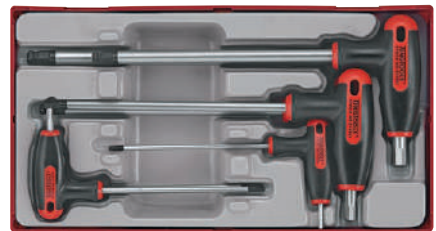

T-HANDLE BALL POINT HEX KEY SET TTI 7 PIECES



»	2.5, 3, 4, 5, 6, 7, 8	
TTHEX7	810 g	£68.50



T-HANDLE HEX KEY SET TTI 7 PIECES



»	2.5, 3, 4, 5, 6, 7, 8	
TTHEX7S	805 g	£68.50



T-HANDLE BALL POINT HEX KEY SET AF TTI 7 PIECES



» 3/32, 1/8, 5/32, 3/16, 7/32, 1/4, 5/16		
TTHEX7AF	811 g	£68.50



BALL POINT HEX & TX KEY SET TTI 28 PIECES



» Ball Point Hex Key AF 5/64, 3/32, 1/8, 5/32, 3/16, 7/32, 1/4, 5/16, 3/8		
» Ball Point Hex Key Metric 1.5, 2, 2.5, 3, 4, 5, 6, 7, 8, 10		
» TX Key TX8, TX9, TX10, TX15, TX20, TX25, TX27, TX30, TX40		
TTHT28	1177 g	£92.50



T-HANDLE TX/TPX KEY SET TTI 7 PIECES



» TX10, TX15, TX20, TX25, TX27, TX30, TX40		
TTTX7	675 g	£65.50



NUT DRIVER SET TTX4 9 PIECES



» 5, 5.5, 6, 7, 8, 10, 11, 12, 13		
TTXND	1449 g	£146.90





PLIER SET VINYL GRIP TTI 3 PIECES



- » Heavy Duty Side Cutting Plier 160 mm
- » Heavy Duty Combination Plier 185 mm
- » Long Nose Plier 200 mm



TTMB03

781 g

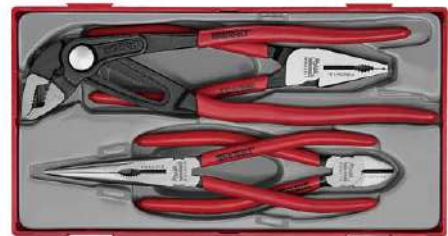

PLIER SET VINYL GRIP Q TTI 4 PIECES



- » Side Cutting Plier 160 mm
- » Heavy Duty Combination Plier 185 mm
- » Long Nose Plier 200 mm
- » Quick Set Water Pump Plier HRC60 250 mm



TT440Q

1085 g

£122.50

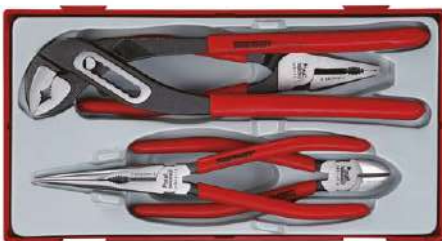

PLIER SET VINYL GRIP TTI 4 PIECES



- » Side Cutting Plier 160 mm
- » Heavy Duty Combination Plier 185 mm
- » Long Nose Plier 200 mm
- » Water Pump Plier 240 mm



TT440

1087 g

£116.90



PLIER SET TPR GRIP TTI 4 PIECES



- » Side Cutting Plier TPR Grip 160 mm
- » Heavy Duty Combination Plier TPR Grip 190 mm
- » Long Nose Plier TPR Grip 205 mm
- » Water Pump Plier TPR Grip 250 mm



TT440-T

1190 g

£124.90



PLIER SET TPR GRIP Q TTI 4 PIECES



- » Side Cutting Plier TPR Grip 160 mm
- » Heavy Duty Combination Plier TPR Grip 190 mm
- » Long Nose Plier TPR Grip 205 mm
- » Quick Set Water Pump Plier TPR Grip HRC60 250 mm



TT440-TQ

1153 g

£133.50

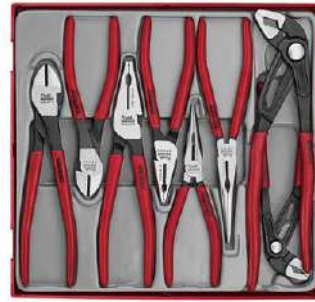

PLIER SET VINYL GRIP Q TT2 8 PIECES



- » Heavy Duty Side Cutting Plier 160 mm
- » Heavy Duty Side Cutting Plier 200 mm
- » Heavy Duty Combination Plier 165 mm
- » Heavy Duty Combination Plier 200 mm
- » Long Nose Plier 165 mm
- » Long Nose Plier 200 mm
- » Quick Set Water Pump Plier HRC60 250 mm
- » Quick Set Water Pump Plier HRC60 185 mm



TTD441Q

1995 g

£256.90





CIRCLIP PLIER SET PRO 10-25 MM TTI 4 PIECES



- » Circlip Plier Inner Straight PRO 135 mm
- » Circlip Plier Inner Bent PRO 125 mm
- » Circlip Plier Outer Straight PRO 135 mm
- » Circlip Plier Outer Bent PRO 125 mm



TT474-5E

605 g

£108.90



CIRCLIP PLIER SET PRO 40-100 MM TTX4 4 PIECES



- » Circlip Plier Inner Straight PRO 225 mm
- » Circlip Plier Inner Bent PRO 220 mm
- » Circlip Plier Outer Straight PRO 225 mm
- » Circlip Plier Outer Bent PRO 220 mm



TTX474-9E

1592 g

£184.90



CIRCLIP PLIER SET PRO 19-60 MM TTI 4 PIECES



- » Circlip Plier Inner Straight PRO 175 mm
- » Circlip Plier Inner Bent PRO 175 mm
- » Circlip Plier Outer Straight PRO 175 mm
- » Circlip Plier Outer Bent PRO 165 mm



TT474-7E

922 g

£114.90



POWER GRIP PLIER SET TTI 5 PIECES



- » Curved Jaw Power Grip Plier 235 mm
- » Curved Jaw Power Grip Plier 105 mm
- » Curved Jaw Power Grip Plier 190 mm
- » Long Nose Power Grip Plier 125 mm
- » Long Nose Power Grip Plier 170 mm



TTVG05

1494 g

£102.90

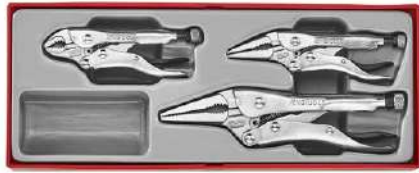

POWER GRIP PLIER SET TTX2 3 PIECES



- » Curved Jaw Power Grip Plier 105 mm
- » Long Nose Power Grip Plier 125 mm
- » Long Nose Power Grip Plier 170 mm



TTVVG03 559 g £61.90

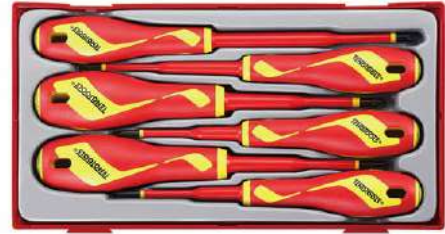

INSULATED SCREWDRIVER SET MIXED TTI 6 PIECES



- » Flat Slim Insulated Screwdriver
0.8×4.0, 1.0×5.5
- » PH Slim Insulated Screwdriver
PH1, PH2
- » PZ Slim Insulated Screwdriver
PZ1, PZ2



TTV706N 648 g £60.50



POWER GRIP PLIER SET TT4 4 PIECES



- » Long Nose Power Grip Plier 170 mm
- » C Clamp Power Grip Plier 280 mm
- » Welding Power Grip Plier 230 mm
- » Sheet Metal Power Grip Plier 230 mm



TTPSPG 2376 g £119.90



INSULATED SCREWDRIVER SET MIXED TTI 7 PIECES



- » Flat Insulated Screwdriver
0.4×2.5, 0.8×4.0, 1.0×5.5
- » PH Insulated Screwdriver
PH0, PH1, PH2
- » PZ Insulated Screwdriver PZ2



TTV907N 671 g £59.90





INSULATED SCREWDRIVER SET MIXED TT2 10 PIECES



- » Flat Insulated Screwdriver
 - » 0.4×2.5, 0.5×3.0, 0.8×4.0, 1.0×5.5
- » PH Insulated Screwdriver
 - » PH0, PH1, PH2
- » PZ Insulated Screwdriver
 - » PZ0, PZ1, PZ2

TTDV910N	1026 g	£93.90



INSULATED TORQUE SCREWDRIVER SET TTI 9 PIECES



- » Insulated Torque Screwdriver 1-5Nm
- » Interchangeable Blade Insulated Screwdriver
 - » 3, 4, 5.5, 6.5, PH1, PH2, PZ1, PZ2

TTVSD09	639 g	£199.90



INSULATED SCREWDRIVER SET INTERCHANGEABLE BLADES TTI 10 PIECES



- » Insulated Handle for Interchangeable Blades L
- » Insulated Handle for Interchangeable Blades S
- » Interchangeable Blade Insulated Screwdriver
 - » 3, 4, 5.5, 6.5, PH1, PH2, PZ1, PZ2

TTV710N	509 g	£62.50



INSULATED PLIER SET TTI 4 PIECES



- » Insulated Side Cutting Plier 160 mm
- » Insulated Combination Plier 185 mm
- » Insulated Long Nose Plier 215 mm
- » Insulated Wire Stripping Plier

TTV440	987 g	£143.90



3/8" INSULATED SOCKET SET TTI 14 PIECES



- » 3/8" Insulated Ratchet 72 Teeth
- » 3/8" Insulated Extension Bar 75 mm
- » 3/8" Insulated Socket
- » 8, 9, 10, 11, 12, 13, 14, 15, 16, 17, 18, 19



TTV3814

1204 g

£332.90



CUTTING TOOL SET TT2 6 PIECES



- » Compact tin snip straight cut Cr-Mo 190 mm
- » Compact tin snip straight/right cut Cr-Mo 182 mm
- » Compact tin snip straight/left cut Cr-Mo 182 mm
- » Scissors 5-1/2"
- » Deburring Tool Pocket Clip
- » Scriber With Carbide Tip



TTDCT06

1250 g

£181.50



CUTTING TOOL SET TT2 5 PIECES



- » Tin Snip Right/Straight
- » Tin Snip Left/Straight
- » Heavy Duty Cable Cutter Bi Material Handle 250 mm
- » Scissors 5-1/2"
- » Quick Action Utility Knife



TTDCT05

2102 g

£169.90



KNIFE SET TTI 40 PIECES



- » Replacement Snap Off Blades 9 mm 10 pcs
- » Snap Off Knife 18 mm Plastic Housing
- » Snap Off Knife Knife 9 mm Plastic Housing
- » Replacement Snap Off Blades 18 mm 10 pcs
- » Replacement Blades Mini Folding Utility Knife 10 pcs
- » Safety Utility Knife
- » Folding Utility Knife
- » Mini Folding Utility Knife



TTK40

942 g

£93.50





DRILL BIT SET 1.0-13.0 MM TT2 28 PIECES



- » 1 (×3), 1.5 (×3), 2 (×2), 2.5 (×2), 3, 3.5, 4, 4.5, 5, 5.5, 6, 6.5, 7, 7.5, 8, 8.5, 9, 10, 10.5, 11, 12, 13



TTDB28

864 g

£137.50



TAP AND DIE SET TT1 17 PIECES



- » Die Handle M3 - M12
- » Pitch Gauge
- » Tap Handle M3 - M12
- » Die
 - » M3×0.5, M4×0.7, M5×0.8, M6×1.0, M8×1.25, M10×1.5, M12×1.75
- » Tap
 - » M3×0.5, M4×0.7, M5×0.8, M6×1.0, M8×1.25, M10×1.5, M12×1.75



TTTD17

773 g

£104.50



TAP AND DIE SET TT2 34 PIECES



- » 1/4" Mini Palm Ratchet 45 Teeth
- » Drill Bits Fully Ground
 - » 2.5, 3.3, 4.2, 5, 6.8, 8.5, 10.5
- » 1/4" Extension Bar 100 mm
- » 1/4" Die Chuck M3 - M12
- » 1/4" Tap Chuck
 - » M3 - M8, M5 - M12
- » 3/8" Drive Adaptor 3/8" F: 1/4" M with 1/4" hole
- » Hex Mini Screwdriver 2.5
- » Pitch Gauge
- » Screw Extractor
 - » 1, 2, 3, 4, 5
- » Die
 - » M3×0.5, M4×0.7, M5×0.8, M6×1.0, M8×1.25, M10×1.5, M12×1.75
- » Tap
 - » M3×0.5, M4×0.7, M5×0.8, M6×1.0, M8×1.25, M10×1.5, M12×1.75



TTDTD34

1456 g

£285.50



NEEDLE FILE SET TTI 12 PIECES

12 PCS TT SERIES SIZE 1

- » Needle File Flat
- » Needle File Half round
- » Needle File Triangular
- » Needle File Square
- » Needle File Round
- » Needle File Flat point
- » Needle File Knife type
- » Needle File Barrette
- » Needle File Crossing
- » Needle File Oval
- » Needle File Feather
- » Needle File Round edge flat

TTNF12 433 g £55.50



HAND FILE SET TTX4 5 PIECES

5 PCS TT SERIES SIZE x/4

- » Hand File 250 mm Flat
- » Hand File 250 mm Flat Tapered
- » Hand File 250 mm Half round
- » Hand File 250 mm Round
- » Hand File 250 mm Triangular

TTXF05 1715 g £92.90



MEASURING TOOL SET TTI 4 PIECES

4 PCS TT SERIES SIZE 1 AF mm

- » Vernier Caliper 0-150 mm
- » Scriber With Carbide Tip
- » Square Base 100 x 70 mm
- » Steel Rule mm/AF 150 mm

TTBM 605 g £114.50





MEASURING TOOL SET TT2 4 PIECES



- » Digital Caliper 0-150 mm
- » Digital Multimeter
- » Feeler Gauge 0.05-1.0 mm 100 mm 20 Blades
- » Gauge Thread MM/UNC 0.25-6.0 mm



TTDCM



1136 g

£199.90



SCRAPER SET TTI 4 PIECES



- » Gasket Scraper 22 mm
- » Awl Round Tip
- » Hook Tool Curved
- » Cotter Pin Puller



TTSR04



682 g

£54.30



HOCK & PICK SET TTI 4 PIECES



- » Awl Straight
- » Hook Tool 125°
- » Hook Tool 35°
- » Cotter Pin Puller S



TTMDP



361 g

£33.90



CLIP & PANEL REMOVER SET TTI 4 PIECES



- » Panel clip removal tool U-shape
- » Panel clip removal tool U-shape large
- » Trim clip removal tool V-shape
- » Trim clip removal tool V-shape large



TTSR04A



666 g

£49.90



HOSE CLAMP SET TTI 3 PIECES

3 PCS TT SERIES SIZE 1

- » Hose Clamp 6 - 19 mm
- » Hose Clamp 6 - 32 mm
- » Hose Clamp 19 - 57 mm



TTHC03

478 g

£54.90



OIL SERVICE SET TTI 16 PIECES

16 PCS TT SERIES SIZE 1 3/8"

- » Telescopic Inspection Tool 3 in 1
- » 1/2" Oil Filter Removal Tool Strap Type 130 mm
- » Drain Plug
 - » 5/16x3/8, 8x10, 8x3/8, 11, 13, 17x1/2
- » Feeler Gauge 0.05-1.0 mm 100 mm 20 Blades
- » Reducing Adaptor 1/2"F - 3/8"M
- » 3/8" Extension Bar 75 mm
- » 3/8" Wobble Extension Bar 255 mm
- » 3/8" Spark Plug Socket
 - » 16, 21
- » 3/8" Socket 6 pt Metric 21 mm



TTOS16

1789 g

£124.50



AUTOMOTIVE SOCKET SET TTI 7 PIECES

7 PCS TT SERIES SIZE 1 3/8" 1/2"

- » 1/2" Fuel Injector Socket
- » 1/2" Lambda Oxygen Sensor Sockets Straight 29 mm
- » 3/8" Lambda Oxygen Sensor Sockets Offset 7/8"
- » 3/8" Vacuum Switch Socket 7/8"
- » 3/8" Oil Pressure Sender Socket 11/16"
- » 1/2" Heated Lambda Oxygen Sensor Sockets 7/8"
- » 3/8" Lambda Oxygen Sensor Sockets 22 mm



TTSS07

2050 g

£165.90



3/8" LONG T BAR SOCKET SET TTX4 9 PIECES

9 PCS TT SERIES SIZE x4 mm 3/8" 6

- » T Bar Handle Grip
- » T Bar for T Bar Sockets
- » 3/8" T-Bar Deep Socket 6 pt Metric
 - » 8, 10, 12, 13, 14, 17, 19



TTXTB09

2338 g

£174.90





FLARING TOOL SET TTI 10 PIECES

10 PCS TT SERIES SIZE 1

- » Pipe Cutter 3 - 32 mm
- » Flaring Tool
- » Clamp
- » Adaptor 4 mm
- » Adaptor 4.75 mm
- » Adaptor 6 mm
- » Adaptor 8 mm
- » Adaptor 10 mm
- » Adaptor 12 mm
- » Adaptor 14 mm

TTTF10 1648 g £119.90



PULLER SET TTI 4 PIECES

4 PCS TT SERIES SIZE 1

- » Long Screw
- » Replacement Arm
- » Plate
- » Screw
- » Three Arm Holder
- » Two Arm Holder

TT804 1419 g £89.90



BODYWORK HAMMER SET TT4 5 PIECES

5 PCS TT SERIES SIZE 4

- » Body Working Hammer Round Crown Face/Straight Pein
- » Body Working Hammer Round Crown Face/Point Pin
- » Body Working Hammer Round Crown Face/Square Milled
- » Hammer Dead Blow 35 mm Diameter Head 300g
- » Hammer Dead Blow 55 mm Diameter Head 980g

TTPSAD 2659 g £224.90



EXTRACTOR & NUT SPLITTER SET TTI 11 PIECES

11 PCS TT SERIES SIZE 1

- » Nut Splitter Set 2 Pieces 5-20mm & 14-27 mm
- » Screw Extractor Set Spiral 5 Pieces
- » 1/2" Stud Extractor Socket 6, 8, 10, 12

TTSN11 1520 g £124.90



STUD EXTRACTOR SET TTI 18 PIECES

18 PCS TT SERIES SIZE 1 3/8" 1/2" DIN 3120

☰		
»	Parallel Pin Punch 4 mm	
»	1/2" Stud Extractor	
»	19, 21, 22, 24, 25	
»	3/8" Stud Extractor	
»	3/8, 1/2, 11/16, 6, 8, 10, 11, 12, 13, 14, 16, 17	
TTBE18	1834 g	£555.90



PRY BAR SET TTX4 3 PIECES

3 PCS TT SERIES SIZE x4

☰		
»	Pry Bar 300 mm	
»	Pry Bar 450 mm	
»	Pry Bar 550 mm	
TTXPB3A	1816 g	£83.50



PRY BAR SET ROLL/HEEL TTX4 3 PIECES

3 PCS TT SERIES SIZE x4

☰		
»	Pry Bar Roll Heel Type 300 mm	
»	Pry Bar Roll Heel Type 400 mm	
»	Pry Bar Roll Heel Type 500 mm	
TTXPB3	2117 g	£102.50



CRIMPING PLIER SET TTI 121 PIECES

121 PCS TT SERIES SIZE 1

☰		
»	Butt Splice Connector Blue 1.5-2.5 mm ² × 20	
»	Butt Splice Connector Red 0.5-1.5 mm ² × 20	
»	Crimping Plier 9" Red Handle	
»	Female Spade Terminal Blue 1.5-2.5 mm ² × 20	
»	Fork Terminal Blue 1.5-2.5 mm ² × 20	
»	Male Spade Terminal Blue 1.5-2.5 mm ² × 20	
»	Ring Terminal Red M4/0.5-1.5 mm ² × 20	
TTCP121	577 g	£53.90





CRIMPING PLIER SET TTI 4 PIECES



» Ratcheting Crimping Plier With Three Heads



TTCP04

877 g

£147.90



RIVET GUN SET TTI 81 PIECES



- » Aluminium Rivets 2.4 mm × 20
- » Aluminium Rivets 3.2 mm × 20
- » Aluminium Rivets 4.0 mm × 20
- » Aluminium Rivets 4.8 mm × 20
- » Hand Rivet Gun Aluminium Alloy 2.4/3.2/4.0/4.8 mm



TTHR81

917 g

£113.90



PIPE CUTTER SET TTI 6 PIECES



- » Deburring Tool
- » Pipe Cutter 3 - 22 mm
- » Rotating Pipe Cutter 10 mm
- » Rotating Pipe Cutter 12 mm
- » Rotating Pipe Cutter 15 mm
- » Rotating Pipe Cutter 22 mm



TTTC06

1067 g

£154.90



NUTSERT GUN SET TTI 81 PIECES



- » Nutsert Gun M3/M4/M5/M6
- » Nutsert M3 × 20
- » Nutsert M4 × 20
- » Nutsert M5 × 20
- » Nutsert M6 × 15



TTNR81

1043 g

£212.90



INSPECTION SET TTI 3 PIECES

3 PCS TT SERIES SIZE 1

- » Telescopic Magnifying Glass
- » Telescopic Inspection Mirror
- » Telescopic Magnetic Pick Up Tool



TTTM03 476 g £83.20



RECHARGEABLE LAMP SET TTI 3 PIECE

3 PCS TT SERIES SIZE 1

- » Rechargeable LED flashlight 1200 lm
- » Rechargeable multi-purpose LED headlamp 400 lm
- » Rechargeable LED worklight 1000 lm



TTLA03 857 g



PUNCH & CHISEL SET TTI 9 PIECES

9 PCS TT SERIES SIZE 1

- » Flat Cold Chisel
- » 18, 25
- » Centre Punch 5 mm
- » Parallel Pin Punch
- » 3, 4, 5, 6, 7, 8



TTPC09 1428 g £86.90



FOAM SERIES TOOL KITS

BETTER TOOLS BRING BETTER RESULTS

Each tool kit has been compiled with the help of technicians from various trades and are available in many shapes and sizes. From full stacks to roller cabinets, and top boxes to portable solutions, there is a kit to fit your exact needs

FOAM SERIES



Protection: FOAM Series tool trays provide a protective layer between the tools and the storage solution, helping to prevent damage and scratching.



Organisation: Each tool has its own place with its description imprinted in the 3-coloured foam. The contrasting colours make it easy to identify tools and see when a tool is missing.



Customisability: We can provide a bespoke custom FOAM Series toolkit based around your existing tools and equipment. Contact your local retailer for more information.



Safety: FOAM Series tool trays can also help reduce the risk of injury by keeping sharp or dangerous tools secure and separated from other tools.



Cold environments: The high quality FOAM stays soft and flexible even in cold environments and gives the tool kit a premium look.

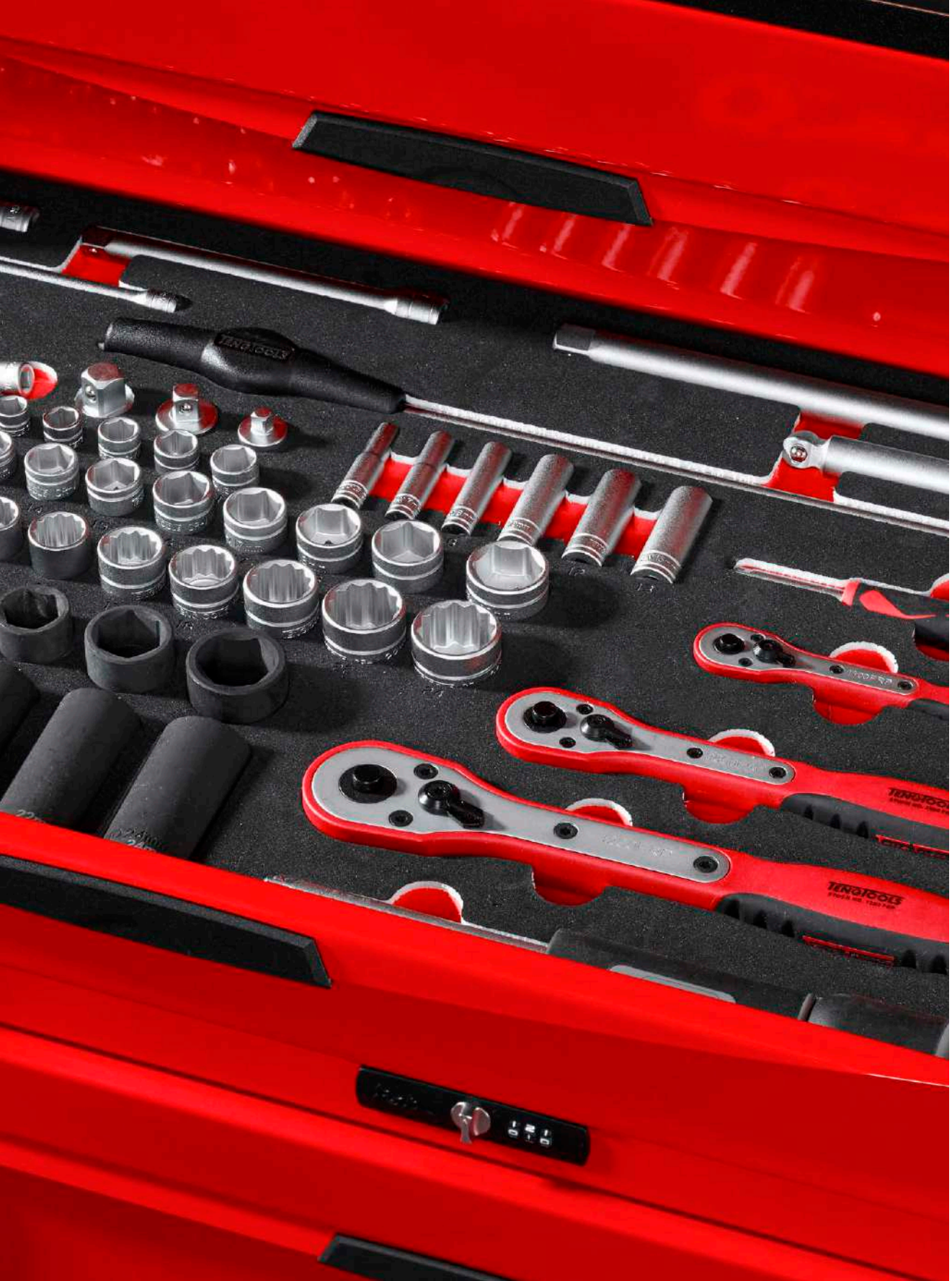

PRO35™









MONSTER™

NEW

53" PRO35™ MONSTER STACK FOAM TOOL KIT 1133 PIECES RED

1133
PIECES

FOAM
SERIES

-  **19** Drawer
-  **3-Piece Cabinet Frame**
-  **Heavy Gauge Steel**
-  **5-Step Phosphate-Free Rust Protection**
-  **53" Wide Cabinet**
-  **6" x 2" Castor Wheels with Brakes**
-  **3 Step Ball Bearing Slides**
-  **Comfort Grip Handle**
-  **Combination Lock**



Drawer	Item ID	Description
	TST53R10F	53" PRO35™ tool chest 10 drawers red
	TSW53R9	53" PRO35™ roller cabinet 9 drawers red
	TCF07	Fixing brackets for 26", 37" & 53" deep tool chest
	TCA08	Paper roll holder for side handle
1/10	TEABS50	Impact Bit Set FOAM1
1/10	TEAMDQ78	Bits Driver Set FOAM1
1/10	TEAHR81	Rivet Gun Set FOAM1
1/10	TEAMDV10	Insulated Interchangeable Blade Set FOAM1
1/10	TEXEXT13	Extension Bars Set FOAMX4
2/10	TEDV3818	3/8" Insulated Socket Set FOAM2
2/10	TEDV440	Insulated Plier Set FOAM2
2/10	TEXTB05	3/8" T Bar Spark Plug Socket Set FOAMX4
3/10	TEDSD14	Torque Screwdriver Set FOAM2
3/10	TEDHT42	Ball Point Hex & TX Key Set FOAM2
3/10	TEXMDTN	Power Through Screwdriver Set FOAMX4
4/10	TEDPC14	Punsch & Chisel Set FOAM2
4/10	TEDDF7	Double Flex Wrench Set FOAM2
4/10	TEXFLS06	Long Double Ring Spanner Set FOAMX4
5/10	TEDADJ4	Adjustable Wrench Set FOAM2
5/10	TEDIMM	Measuring Tool Set FOAM2
5/10	TEXPB4	Pry Bar Set Roll/Heel FOAMX4
6/10	TEX1238	3/8" & 1/2" Torque Wrench Set FOAMX4
6/10	TEXW05	Wheel Tool Set FOAMX4
7/10	TTEVG11	Power Grip Plier Set FOAM4X4
8/10	TTEMB14Q	Plier Set Vinyl Grip Q FOAM4X4
9/10	TTEMDI22N	Screwdriver Set Mixed FOAM4X4
10/10	TTEX23N	Nut Driver & Hex/TX T-Handle Set FOAM4X4
1/9	TTESK86	1/4" & 3/8" Socket Set FOAM4X4
1/9	TTESK63	1/2" Socket Set 12 pt FOAM4X4
2/9	TTESK85	1/4", 3/8" & 1/2" Socket Set FOAM4X4
3/9	TTEPS12	General Tool Set FOAM4X4
4/9	TTESP37	Spanner Set FOAM4X4
5/9	TTESP31	Combination Spanner Set FOAM4X4
6/9	TTEAF62	Socket & Combination Spanner Set AF FOAM4X4
7/9	TTEISK73	3/8" & 1/2" Impact Socket Set FOAM4X4
8/9	TTESK32	3/4" Socket Set FOAM4X4
9/9	TTEISK33	3/4" Impact Socket Set DIN FOAM4X4



TKSS3R1133F

£17,649.00











PRO35™

26" PRO35™ STACK FOAM TOOL KIT 418 PIECES RED

418
PIECES

FOAM
SERIES

-  **11** Drawer
-  **3-Piece Cabinet Frame**
-  **Heavy Gauge Steel**
-  **5-Step Phosphate-Free Rust Protection**
-  **26" Wide Cabinet**
-  **5" x 1-1/4" Castor Wheels with Brakes**
-  **3 Step Ball Bearing Slides**
-  **Comfort Grip Handle**
-  **Combination Lock**

NEW



Drawer	Item ID	Description
	TST26R4	26" PRO35™ tool chest 4 drawers red
	TSW26R7	26" PRO35™ roller cabinet 7 drawers red
	TCF06	Fixing brackets for 26" 4-drawer tool chest
	TCA08	Paper roll holder for side handle
1/4	EMPTY	
2/4	EMPTY	
3/4	EMPTY	
4/4	TEDTX7	T-Handle Ball Point TX Key Set FOAM2
4/4	TEDHEX7	T-Handle Ball Point Hex Key Set FOAM2
1/7	TED1489	1/4" Socket Set 6 pt FOAM2
1/7	TED3836	3/8" Socket Set 6 pt FOAM2
1/7	TEXEXT13	Extension Bars Set FOAMX4
2/7	TED1227	1/2" Socket Set 12 pt FOAM2
2/7	TED441Q	Plier Set Vinyl Grip Q FOAM2
2/7	TEX1238	3/8" & 1/2" Torque Wrench Set FOAMX4
3/7	TED911N	Screwdriver Set Mixed FOAM2
3/7	TED909TXN	Screwdriver Set TX FOAM2
3/7	TEX915N	Screwdriver Set Flat & PH FOAMX4
4/7	TEDPC14	Punch & Chisel Set FOAM2
4/7	TEDSD14	Torque Screwdriver Set FOAM2
4/7	TEXPB4	Pry Bar Set Roll/Heel FOAMX4
5/7	TED8012	Combination Spanner Set Anti Slip FOAM2
5/7	TEDADJ4	Adjustable Wrench Set FOAM2
5/7	TEX2032	Combination Spanner Set FOAMX4
6/7	TED9121	1/2" Impact Socket Set ANSI FOAM2
6/7	TEDHT42	Ball Point Hex & TX Key Set FOAM2
6/7	TEXW05	Wheel Tool Set FOAMX4
7/7	EMPTY	



TKS26R418F

£5,199.00











PRO35™

26" PRO35™ STACK FOAM TOOL KIT 528 PIECES RED

528
PIECES

FOAM
SERIES

-  **12** Drawer
-  **3-Piece Cabinet Frame**
-  **Heavy Gauge Steel**
-  **5-Step Phosphate-Free Rust Protection**
-  **26" Wide Cabinet**
-  **5" x 1-1/4" Castor Wheels with Brakes**
-  **3 Step Ball Bearing Slides**
-  **Comfort Grip Handle**
-  **Combination Lock**

NEW



Drawer	Item ID	Description
	TST26R5F	26" PRO35™ deep tool chest 5 drawers red
	TSW26R7	26" PRO35™ roller cabinet 7 drawers red
	TCA08	Paper roll holder for side handle
1/5	TTESK86	1/4" & 3/8" Socket Set FOAM4X4
2/5	TTESK63	1/2" Socket Set 12 pt FOAM4X4
3/5	TTEISK73	3/8" & 1/2" Impact Socket Set FOAM4X4
4/5	TTEISK33	3/4" Impact Socket Set DIN FOAM4X4
5/5	TTESK32	3/4" Socket Set FOAM4X4
1/7	TTEX23N	Nut Driver & Hex/TX T-Handle Set FOAM4X4
2/7	TTEMB14Q	Plier Set Vinyl Grip Q FOAM4X4
3/7	TTEMD122N	Screwdriver Set Mixed FOAM4X4
4/7	TTEVG11	Power Grip Plier Set FOAM4X4
5/7	TTESP31	Combination Spanner Set FOAM4X4
6/7	TTESP37	Spanner Set FOAM4X4
7/7	EMPTY	



TKS26R528F

£9,311.00











PRO35™

26" PRO35™ STACK FOAM TOOL KIT 702 PIECES RED

702
PIECES

FOAM
SERIES

-  **12** Drawer
-  **3-Piece Cabinet Frame**
-  **Heavy Gauge Steel**
-  **5-Step Phosphate-Free Rust Protection**
-  **26" Wide Cabinet**
-  **5" x 1-1/4" Castor Wheels with Brakes**
-  **3 Step Ball Bearing Slides**
-  **Comfort Grip Handle**
-  **Combination Lock**

NEW



Drawer	Item ID	Description
	TST26R5F	26" PRO35™ deep tool chest 5 drawers red
	TSW26R7	26" PRO35™ roller cabinet 7 drawers red
	TCA08	Paper roll holder for side handle
1/5	TTEMD115N	Screwdriver Set Mixed FOAM4X4
2/5	TTEX18	General Tool Set FOAM4X4
3/5	TTEX219	General Service Tool Set FOAM4X4
4/5	TTEMB13Q	Plier Set Q FOAM4X4
5/5	EMPTY	
1/7	TTEX23N	Nut Driver & Hex/TX T-Handle Set FOAM4X4
2/7	TTESP31A	Combination Spanner Set FOAM4X4
3/7	TTESK67	1/4", 3/8" & 1/2" drive metric socket set
4/7	TTESK85	1/4", 3/8" & 1/2" Socket Set FOAM4X4
5/7	TTESK25	3/4" Socket & Spanner Set
6/7	TTEISK103	1/2" Impact Socket Set FOAM4X4
7/7	EMPTY	



TKS26R702F

£7,899.00



NEW

PRO35™

37" PRO35™ ROLLER CABINET FOAM TOOL KIT 637 PIECES RED

637
PIECES

FOAM
SERIES

- 7 Drawer
- 3-Piece Cabinet Frame
- Heavy Gauge Steel
- 5-Step Phosphate-Free Rust Protection
- 37" Wide Cabinet
- 5" x 2" Castor Wheels with Brakes
- 3 Step Ball Bearing Slides
- Comfort Grip Handle
- Combination Lock



Drawer	Item ID	Description
	TSW37R7	37" PRO35™ roller cabinet 7 drawers red
	TC-TB03	Work Top for 37" Cabinet
	TCA08	Paper roll holder for side handle
1/7	TTESK77	1/4", 3/8" & 1/2" Socket Set FOAM4X4
1/7	TEDHT42	Ball Point Hex & TX Key Set FOAM2
1/7	TEZ01	Storage Tray FOAMX2 3 Compartments
2/7	TTEX32	Spanner & File Set FOAM4X4
2/7	TEDDF7	Double Flex Wrench Set FOAM2
2/7	TEZ01	Storage Tray FOAMX2 3 Compartments
3/7	TTEM122N	Screwdriver Set Mixed FOAM4X4
3/7	TEDV909N	Insulated Screwdriver Set Mixed FOAM2
3/7	TEZ01	Storage Tray FOAMX2 3 Compartments
4/7	TTEMB13Q	Plier Set Q FOAM4X4
4/7	TEDV440	Insulated Plier Set FOAM2
4/7	TEZ01	Storage Tray FOAMX2 3 Compartments
5/7	TTESK85	1/4", 3/8" & 1/2" Socket Set FOAM4X4
5/7	TEDSD14	Torque Screwdriver Set FOAM2
5/7	TEZ01	Storage Tray FOAMX2 3 Compartments
6/7	TTEPS12	General Tool Set FOAM4X4
6/7	TEAHR81	Rivet Gun Set FOAM1
6/7	TEABS50	Impact Bit Set FOAM1
6/7	TEZ01	Storage Tray FOAMX2 3 Compartments
7/7	EMPTY	



TKW37R637F

£5,999.00



NEW

PRO35™

37" PRO35™ ROLLER CABINET FOAM TOOL KIT 513 PIECES RED

513
PIECES

FOAM
SERIES

- 7 Drawer
- 3-Piece Cabinet Frame
- Heavy Gauge Steel
- 5-Step Phosphate-Free Rust Protection
- 37" Wide Cabinet
- 5" x 2" Castor Wheels with Brakes
- 3 Step Ball Bearing Slides
- Comfort Grip Handle
- Combination Lock



Drawer	Item ID	Description
	TSW37R7	37" PRO35™ roller cabinet 7 drawers red
	TCA08	Paper roll holder for side handle
1/7	TED911N	Screwdriver Set Mixed FOAM2
1/7	TEDTX7	T-Handle Ball Point TX Key Set FOAM2
1/7	TEDHEX7	T-Handle Ball Point Hex Key Set FOAM2
1/7	TEXMDTN	Power Through Screwdriver Set FOAMX4
1/7	TEZVG03	Power Grip Plier Set FOAMX2
2/7	TTESP31A	Combination Spanner Set FOAM4X4
2/7	TED1489	1/4" Socket Set 6 pt FOAM2
2/7	TEZSN06	Extractor and Nut Splitter Set FOAMX2
3/7	TTESK63	1/2" Socket Set 12 pt FOAM4X4
3/7	TED3836	3/8" Socket Set 6 pt FOAM2
3/7	TEZ01	Storage Tray FOAMX2 3 Compartments
4/7	TTESK85	1/4", 3/8" & 1/2" Socket Set FOAM4X4
4/7	TED441-TQ	Plier Set TPR Grip Q FOAM2
4/7	TEZ01	Storage Tray FOAMX2 3 Compartments
5/7	TTEISK33	3/4" Impact Socket Set DIN FOAM4X4
5/7	TED909TXN	Screwdriver Set TX FOAM2
5/7	TEZ01	Storage Tray FOAMX2 3 Compartments
6/7	TTESK25	3/4" Socket & Spanner Set
6/7	TED6512R	Ratcheting Combination Spanner Set R FOAM2
6/7	TEZ01	Storage Tray FOAMX2 3 Compartments
7/7	TTEISK73	3/8" & 1/2" Impact Socket Set FOAM4X4
7/7	TEDPC14	Punsch & Chisel Set FOAM2
7/7	TEZ01	Storage Tray FOAMX2 3 Compartments



TKW37R513F

£7,999.00



NEW

PRO35™

26" PRO35™ ROLLER CABINET FOAM TOOL KIT 335 PIECES RED

335
PIECES

FOAM
SERIES

- 7 Drawer
- 3-Piece Cabinet Frame
- Heavy Gauge Steel
- 5-Step Phosphate-Free Rust Protection
- 26" Wide Cabinet
- 5" x 1-1/4" Castor Wheels with Brakes
- 3 Step Ball Bearing Slides
- Comfort Grip Handle
- Combination Lock



Drawer	Item ID	Description
	TSW26R7	26" PRO35™ roller cabinet 7 drawers red
	TCA08	Paper roll holder for side handle
1/7	TTEMB13Q	Plier Set Q FOAM4X4
2/7	TTEMD98N	Screwdriver Set Mixed FOAM4X4
3/7	TTEPS12	General Tool Set FOAM4X4
4/7	TTESK85	1/4", 3/8" & 1/2" Socket Set FOAM4X4
5/7	TTESK77	1/4", 3/8" & 1/2" Socket Set FOAM4X4
6/7	TTEX17	General Tool Set FOAM4X4
7/7	TTEX32	Spanner & File Set FOAM4X4



TKW26R335F

£4,699.00

PRO35™

NEW

26" PRO35™ ROLLER CABINET FOAM TOOL KIT 278 PIECES RED

278
PIECES

FOAM
SERIES

- 7** Drawer
- 3-Piece Cabinet Frame**
- Heavy Gauge Steel**
- 5-Step Phosphate-Free Rust Protection**
- 26" Wide Cabinet**
- 5" x 1-1/4" Castor Wheels with Brakes**
- 3 Step Ball Bearing Slides**
- Comfort Grip Handle**
- Combination Lock**

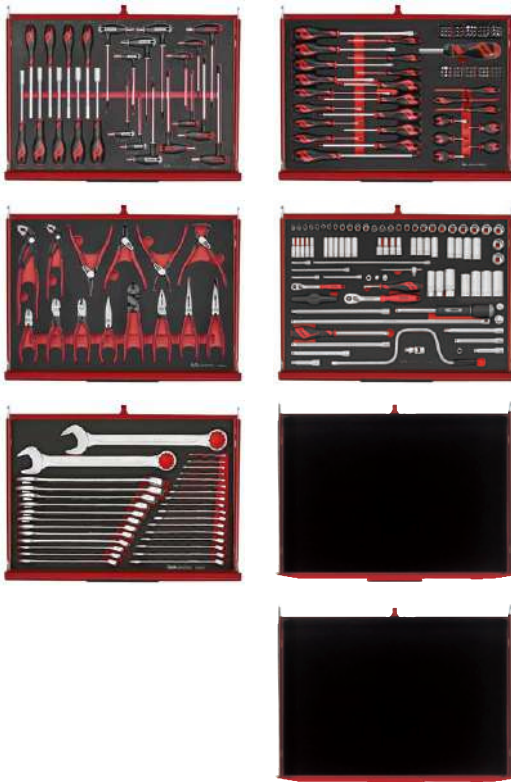

Drawer	Item ID	Description
	TSW26R7	26" PRO35™ roller cabinet 7 drawers red
	TCA08	Paper roll holder for side handle
1/7	TTEX23N	Nut Driver & Hex/TX T-Handle Set FOAM4X4
2/7	TTEM122N	Screwdriver Set Mixed FOAM4X4
3/7	TTESK86	1/4" & 3/8" Socket Set FOAM4X4
4/7	TTEMB14Q	Plier Set Vinyl Grip Q FOAM4X4
5/7	TTESP31	Combination Spanner Set FOAM4X4
6/7	EMPTY	
7/7	EMPTY	



TKW26R278F

£3,769.00



CLASSIC™

26" CLASSIC ROLLER CABINET FOAM TOOL KIT
179 PIECES RED

179
PIECES

FOAM
SERIES



Drawer	Item ID	Description
	TCW707EV	26" CLASSIC Cabinet 7 Drawers Red
1/7	TTEPS25	General Tool Set FOAM4X4 25 Pieces
2/7	TTESK126	1/4" & 1/2" Socket Set 6 pt FOAM4X4 126 Pieces
3/7	TTESP28	General Tool Set FOAM4X4 28 Pieces
4, 5, 6, 7	EMPTY	



TCMME179

£2,099.00

CLASSIC™

27" CABINET FOAM TOOL KIT 217 PIECES RED

217
PIECES

FOAM
SERIES

DIN

ISO

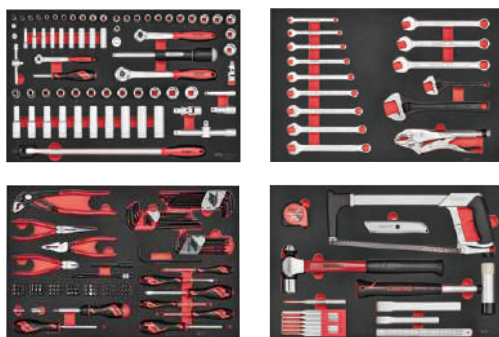

Drawer	Item ID	Description
	TCW707K	27" Classic roller cabinet 7 drawers red
1/7	TTESK73	1/4", 3/8" & 1/2" Socket set FOAM4X4 73 pieces
2/7	TTEMD114	Screwdriver & plier set FOAM4X4 114 pieces
3/7	TTESP15	Spanner set FOAM4X4 15 pieces
4/7	TTEX15	General tool set FOAM4X4 15 pieces
5, 6, 7	EMPTY	



TCMME217K

27" Classic roller cabinet foam tool kit
217 pieces red

£2,375.00

MECCA PRO™

MECCA PRO TC-9 FOAM TOOL KIT 118 PIECES

118
PIECES

FOAM
SERIES



Combination Lock



Section	Item ID	Description
1/3	TEFMD54	Screwdriver, Hex Key & MM Tape FOAM3 54 Pieces
2/3	TEFMB7	General Tool Set Carpenters Hammer FOAM3 7 Pieces
3/3	TEFSK57	Spanner & Socket Set FOAM3 57 Pieces



SCE1

£1,199.00



MECCA PRO™

MECCA PRO TC-9 FOAM BP TOOL KIT 118 PIECES

118 PIECES **FOAM SERIES** **COMBINATION LOCK**



Section	Item ID	Description
1/3	TEFMD54	Screwdriver, Hex Key & MM Tape FOAM3 54 Pieces
2/3	TEFMB7	General Tool Set Carpenters Hammer FOAM3 7 Pieces
3/3	TEFSK57	Spanner & Socket Set FOAM3 57 Pieces



SCE2

£1,219.00

MECCA PRO™

MECCA PRO TC-9 FOAM TOOL KIT 53 PIECES

56 PIECES **FOAM SERIES** **COMBINATION LOCK**



Section	Item ID	Description
1/3	TEFXV11	Insulated Plier & Screwdriver Set FOAM3 11 Pieces
2/3	TEFSPV17	Insulated Spanner Set FOAM3 17 Pieces
3/3	TEFXV27	Insulated Torque Screwdriver Set FOAM3 27 Piece



SCE3

£1,819.00

MECCA PRO™

MECCA PRO TC-9 FOAM TOOL KIT 226 PIECES

226
PIECES

FOAM
SERIES



Combination Lock



Section	Item ID	Description
1/3	TED911N	Screwdriver Set Mixed FOAM2 11 Pieces
1/3	TEASD38	Torque Screwdriver Set FOAM1 38 Pieces
2/3	TED441-TQ	Plier Set TPR Grip Q FOAM2 5 Pieces
2/3	TEAHR81	Rivet Gun Set FOAM1 81 Pieces
3/3	TED8012	Combination Spanner Set Anti Slip FOAM2 12 Pieces
3/3	TEAMDQ78	Bits Driver Set FOAM1 78 Pieces



SCE4

£1,299.00

MECCA PRO™

MECCA PRO TC-9 FOAM TOOL KIT 52 PIECES

52
PIECES

FOAM
SERIES



Combination Lock



Section	Item ID	Description
1/3	TEFX07A	Electrician Tool Set FOAM3 7 Pieces
2/3	TEFSPV17	Insulated Spanner Set FOAM3 17 Pieces
3/3	TEFXV27	Insulated Torque Screwdriver Set FOAM3 27 Pieces



SCES

£1,899.00



MECCA PRO™

MECCA PRO TC-6T FOAM TOOL KIT 112 PIECES

112
PIECES

FOAM
SERIES



MECCA PRO™

MECCA PRO TC-6T FOAM ELECTRICIAN TOOL KIT 29 PIECES

29
PIECES

FOAM
SERIES



Section	Item ID	Description
1/2	TEFMDI54	Screwdriver, Hex Key & MM/AF Tape FOAM3 54 Pieces
2/2	TEFSK57	Spanner & Socket Set FOAM3 57 Pieces

Section	Item ID	Description
1/2	TEDV909N	Insulated Screwdriver Set Mixed FOAM2
2/2	TEAVSD09	Insulated Torque Screwdriver Set FOAM1 9 Pieces
2/2	TEDV440	Insulated Plier Set FOAM2 4 Pieces
2/2	TEA01	Storage Tray FOAM1 7 Compartments



TC-6TE01

£679.90



TC-6TE02

£596.90

MECCA PRO™

NEW

MECCA PRO TC-6T FOAM ELECTRICIAN TOOL KIT 37 PIECES

37
PIECES

FOAM
SERIES

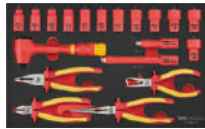

Section	Item ID	Description
1/2	TEFXV17	Insulated Screwdriver Set Mixed FOAM2
2/2	TEFSKV19	Insulated Socket & Pliers Set FOAM3 19 Pieces



TC-6TE03

£914.00

MECCA PRO™

NEW

MECCA PRO TC-6 FOAM ELECTRICIAN TOOL KIT 36 PIECES

36
PIECES

FOAM
SERIES



Section	Item ID	Description
1/2	TEDV440	Insulated Plier Set FOAM2 4 Pieces
1/2	TEAMDV04N	Insulated Screwdriver Set Flat FOAM1 4 Pieces
2/2	TEDV3818	3/8" Insulated Socket Set FOAM2 18 Pieces
2/2	TEAVSD09	Insulated Torque Screwdriver Set FOAM1 9 Pieces



TC-6TE04

£927.00



MECCA PRO™

NEW

MECCA PRO TC-6 FOAM ELECTRICIAN TOOL KIT 29 PIECES

29
PIECES

FOAM
SERIES

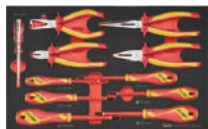

MECCA PRO™

NEW

MECCA PRO TC-6 FOAM ELECTRICIAN TOOL KIT 39 PIECES

39
PIECES

FOAM
SERIES

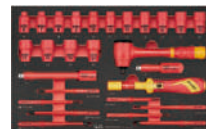
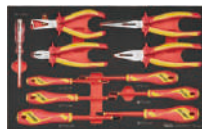

Section	Item ID	Description
1/2	TEFXV11	Insulated Plier & Screwdriver Set FOAM3 11 Pieces
2/2	TEFSPV17	Insulated Spanner Set FOAM3 17 Pieces

Section	Item ID	Description
1/2	TEFXV11	Insulated Plier & Screwdriver Set FOAM3 11 Pieces
2/2	TEFXV27	Insulated Torque Screwdriver Set FOAM3 27 Pieces



TC-6TE05

£893.00



TC-6TE06

£969.00



FOAM SERIES TOOL TRAYS

A FLEXIBLE TOOL CONTROL SYSTEM WITH OVER 240 TOOL SETS

The Foam Series offers the ultimate tool organisation. Each tool has its own place with its description imprinted in the 3-coloured foam. The contrast colours makes it easy to identify tools and see when a tool is missing. The high quality foam stays soft and flexible even in cold environments and gives the tool kit a premium look.

1 CHOOSE YOUR STORAGE

Storages for all needs.



2 CHOOSE YOUR TOOL SETS

Your kit. Your way.



3 ORGANISE YOUR KIT

Optimise your workflow.



FOAM SERIES

SIZE

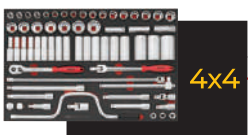
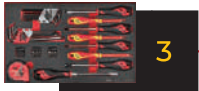

Portable Service case



26" Top & Middle box drawer



26" cabinet drawer



37" cabinet drawer

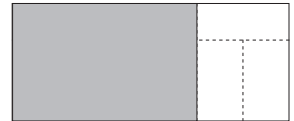
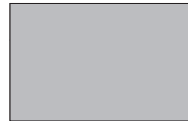
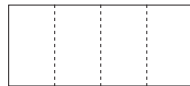
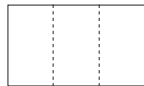
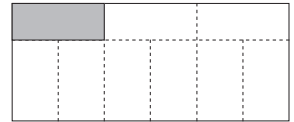
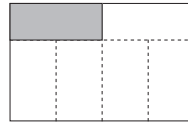
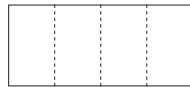
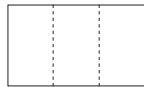
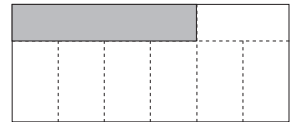
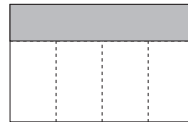
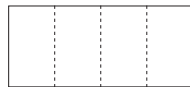
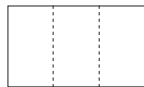
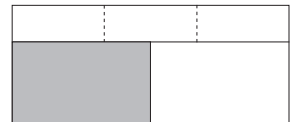
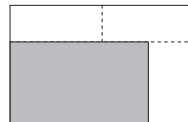
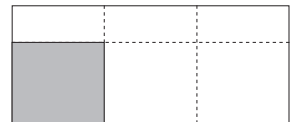
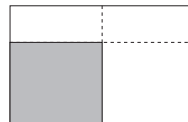
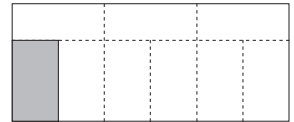
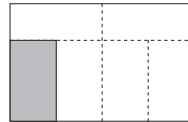
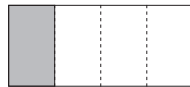
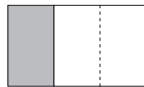



IMPACT BIT SET WITH BELT CLIP MIXED 12 PIECES



- » 1/4" PH G Impact Bits 30 mm PH2G
- » 1/4" Hex Impact Bits 30 mm 3, 4, 5
- » 1/4" Magnetic Impact Bit Holder 60 mm
- » 1/4" PZ Impact Bits 30 mm PZ1, PZ2
- » 1/4" ROB Impact Bits 30 mm 1, 2
- » 1/4" TX Impact Bits 30 mm TX20, TX25, TX30

TJ1413	138 g	£36.90



IMPACT BIT SET CONSTRUCTION WITH BELT CLIP MIXED 12 PIECES



- » 1/4" PH G Impact Bits 30 mm PH2G
- » 1/4" Magnetic Impact Bit Holder 60 mm
- » 1/4" PH Impact Bits 30 mm PH2
- » 1/4" PZ Impact Bits 30 mm PZ1, PZ2, PZ3
- » 1/4" ROB Impact Bits 30 mm 1, 2
- » 1/4" TX Impact Bits 30 mm TX10, TX20, TX25, TX30

TJ1412	138 g	£36.90



IMPACT BIT SET WITH BELT CLIP TX 12 PIECES



- » 1/4" Magnetic Impact Bit Holder 60 mm
- » 1/4" TX Impact Bits 30 mm TX10, TX15, TX20 (*3), TX25 (*2), TX27, TX30 (*2), TX40

TJ1414	138 g	£35.20



STORAGE TRAY FOAM 7 COMPARTMENTS



TEA01	222 g	£24.30



STORAGE TRAY FOAM1 2 COMPARTMENTS



TEA02



216 g

£24.30

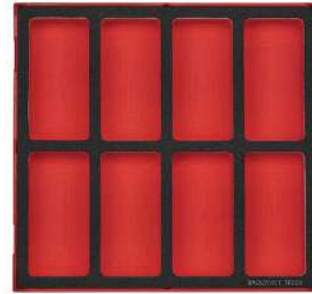

STORAGE TRAY FOAM2 8 COMPARTMENTS



TED01



416 g

£42.20



STORAGE TRAY FOAM2 4 COMPARTMENTS



TED00



400 g

£42.20



STORAGE TRAY FOAMX4 4 COMPARTMENTS



TEX02



306 g

£34.50





STORAGE TRAY FOAMX2 3 COMPARTMENTS



TEZ01

168 g

£21.90



GENERAL TOOL SET FOAM3 7 PIECES



- » Adjustable Wrench Wide Jaw 200 mm
- » Tin Snip High Leverage Straight
- » Utility Knife
- » Carpenters Claw Hammer 16oz
- » Side Cutting Plier TPR Grip 160 mm
- » Long Nose Plier TPR Grip 205 mm
- » Quick Set Water Pump Plier HRC60 250 mm



TEFMB7

2100 g

£260.90



GENERAL TOOL SET BP FOAM3 7 PIECES



- » Adjustable Wrench Wide Jaw 200 mm
- » Tin Snip High Leverage Straight
- » Utility Knife
- » Ball Pein Hammer 16oz
- » Side Cutting Plier TPR Grip 160 mm
- » Long Nose Plier TPR Grip 205 mm
- » Quick Set Water Pump Plier HRC60 250 mm



TEFMBP7

1880 g

£267.90



GENERAL TOOL SET E FOAM3 7 PIECES



- » Adjustable Wrench Wide Jaw 200 mm
- » Tin Snip High Leverage Straight
- » Utility Knife
- » Engineers Hammer 500g
- » Side Cutting Plier TPR Grip 160 mm
- » Long Nose Plier TPR Grip 205 mm
- » Quick Set Water Pump Plier HRC60 250 mm



TEFMBP7E

2305 g

£266.90



GENERAL TOOL SET BP FOAM3 6 PIECES

6 PCS FOAM SERIES SIZE 3

- » Adjustable Wrench Wide Jaw 200 mm
- » Hacksaw Blade Holder 24TPI Metal
- » Utility Knife
- » Snap Off Knife Knife 9 mm Metal Casing
- » Ball Pein Hammer 16oz
- » Quick Set Water Pump Plier HRC60 250 mm



TEFX06 1691 g £187.90



PLUMBER TOOL SET FOAM3 7 PIECES

7 PCS FOAM SERIES SIZE 3

- » Adjustable Wrench Wide Jaw 200 mm
- » Hacksaw Blade Holder 24TPI Metal
- » Vernier Caliper 0-150 mm
- » Deburring Tool
- » Quick Set Water Pump Plier HRC60 250 mm
- » Torpedo Spirit Level Aluminium 230 mm
- » Pipe Cutter 3 - 32 mm



TEFX07 1469 g £304.90



GENERAL TOOL SET E FOAM3 6 PIECES

6 PCS FOAM SERIES SIZE 3

- » Adjustable Wrench Wide Jaw 200 mm
- » Hacksaw Blade Holder 24TPI Metal
- » Utility Knife
- » Snap Off Knife Knife 9 mm Metal Casing
- » Engineers Hammer 500g
- » Quick Set Water Pump Plier HRC60 250 mm



TEFX06E 1714 g £187.90



GENERAL TOOL SET FOAM4x4 15 PIECES

15 PCS FOAM SERIES SIZE 4x4

- » Hacksaw 24TPI Metal
- » Utility Knife
- » Flat Cold Chisel 18, 25
- » Centre Punch 5 mm
- » Ball Pein Hammer 24oz
- » Soft Face Hammer
- » Measuring Tape Metric/Inch 3m
- » Parallel Pin Punch 3, 4, 5, 6, 7, 8
- » Steel Rule mm/AF 200 mm



TTEX15 3950 g £281.00





GENERAL TOOL SET FOAM4X4 15 PIECES



- » Hacksaw Ergonomic Handle 24TPI Metal
- » Folding Utility Knife
- » Flat Cold Chisel 250 × 25 mm
- » Engineers Hammer 800g
- » Heavy Duty Side Cutting Plier TPR Grip 200 mm
- » Heavy Duty Combination Plier TPR Grip 200 mm
- » Long Nose Plier TPR Grip 205 mm
- » Water Pump Plier TPR Grip 250 mm
- » Measuring Tape Metric 3m
- » Parallel Pin Punch
- » 3, 4, 5, 6, 7, 8



TTEPS15

4360 g

£399.90



GENERAL TOOL SET FOAM4X4 17 PIECES



- » Adjustable Wrench TPR Grip 150 mm
- » Adjustable Wrench TPR Grip 250 mm
- » Hacksaw 24TPI Metal
- » Utility Knife
- » Flat Cold Chisel
- » 18, 25
- » Centre Punch 5 mm
- » Engineers Hammer 800g
- » Soft Face Hammer
- » Measuring Tape Metric/Inch 3m
- » Parallel Pin Punch
- » 3, 4, 5, 6, 7, 8
- » Steel Rule mm/AF 200 mm



TTEPS12

4080 g

£349.90



GENERAL TOOL SET FOAM4X4 25 PIECES

25 PCS FOAM SERIES SIZE 4x4 4X4

- » Hacksaw 24TPI Metal
- » Snap Off Knife 18 mm Plastic Housing
- » Replacement Snap Off Blades 18 mm 10 pcs
- » Engineers Hammer 500g
- » Soft Face Hammer
- » Heavy Duty Side Cutting Plier 160 mm
- » Heavy Duty Combination Plier 185 mm
- » Long Nose Plier 165 mm
- » Water Pump Plier 240 mm
- » Measuring Tape Metric/Inch 3m
- » Parallel Pin Punch
- » 3, 4, 5, 6, 7, 8



TTEPS25

3810 g

£349.90



GENERAL TOOL SET FOAM4X4 18 PIECES

18 PCS FOAM SERIES SIZE 4x4 4X4

- » Adjustable Wrench Wide Jaw 150 mm
- » Adjustable Wrench Wide Jaw 250 mm
- » Hacksaw Ergonomic Handle 24TPI Metal
- » Utility Knife
- » Flat Cold Chisel
- » 18, 25
- » Centre Punch 5 mm
- » Ball Pein Hammer 24oz
- » Soft Face Hammer
- » Measuring Tape Metric/Inch 3m
- » Parallel Pin Punch Set 6 Pieces
- » Parallel Pin Punch
- » 3, 4, 5, 6, 7, 8
- » Scriber
- » Steel Rule mm/AF 200 mm



TTEX18

4580 g

£382.90





GENERAL SERVICE TOOL SET FOAM4X4 219 PIECES



- » 1/2" Torque Wrench 40 - 210Nm
- » 1/4" Mini Palm Ratchet 45 Teeth
- » 3/8" Torque Wrench 20 - 110Nm
- » Aluminium Rivets 2.4 mm x 20
- » Aluminium Rivets 3.2 mm x 20
- » Aluminium Rivets 4.0 mm x 20
- » Aluminium Rivets 4.8 mm x 20
- » Drill Bits Fully Ground
 - » 1 (*3), 1.5 (*3), 2 (*2), 2.5, 3, 3.3, 3.5, 4, 4.2, 4.5, 5, 5.5, 6, 6.5, 6.8, 7, 7.5, 8, 8.5, 9, 9.5, 10, 10.5
- » Nutsert Gun M3/M4/M5/M6
- » Hand Rivet Gun Aluminium Alloy 2.4/3.2/4.0/4.8 mm
- » 1/4" Extension Bar 100 mm
- » 1/4" Die Chuck M3 - M12
- » 1/4" Tap Chuck
 - » M3 - M8, M5 - M12
- » 3/8" Drive Adaptor 3/8"F:1/4"M with 1/4" hole
- » Hex Mini Screwdriver 2.5
- » Nutsert M3 x 20
- » Nutsert M4 x 20
- » Nutsert M5 x 20
- » Nutsert M6 x 15
- » Pitch Gauge
- » Screw Extractor
 - » 1, 2, 3, 4, 5
- » Die
 - » M3x0.5, M4x0.7, M5x0.8, M6x1.0, M8x1.25
- » Tap
 - » M3x0.5, M4x0.7, M5x0.8, M6x1.0, M8x1.25, M10x1.5, M12x1.75
- » Screw Extractor Set With Belt Clip 5 Pieces
- » Screw Extractor
 - » 1, 2, 3, 4, 5



TTEX219 5250 g £942.90



GENERAL TOOL SET FOAM4X4 17 PIECES



- » 1/2" Torque Wrench 40 - 210Nm
- » Folding Key Set Mixed 8 Pieces
- » Ball Point Hex Key Metric
 - » 1.5, 2, 2.5, 3, 4, 5, 6, 7, 8, 10
- » TX Key
 - » TX8, TX9, TX10, TX15, TX20, TX25, TX27, TX30, TX40
- » T Handle Ball Point Hex Key Metric
 - » 2.5, 3, 4, 5, 6, 7, 8
- » Telescopic Magnifying Glass
- » Telescopic Inspection Mirror
- » Telescopic Magnetic Pick Up Tool
- » LED Torch With Pocket Clip
- » Hook & Pick Set With Belt Clip 4 Pieces



TTEX17 2770 g £442.90



GENERAL TOOL SET FOAM4X4 28 PIECES

28 PCS **FOAM** SERIES **SIZE 4x4** 4X4

- » Ball Point Hex Key Metric
- » 1.5, 2, 2.5, 3, 4, 5, 6, 8, 10
- » Adjustable Wrench Wide Jaw 200 mm
- » Combination Spanner Metric
- » 8, 10, 11, 12, 13, 14, 15, 16, 17, 18, 19
- » Claw Pick Up Tool
- » Flat Screwdriver
- » 0.6×3.5, 1.0×5.5
- » PH Screwdriver
- » PH1, PH2
- » PZ Screwdriver
- » PZ1, PZ2



TTESP28 2330 g £294.90



SCREWDRIVER SET MIXED FOAM4X4 115 PIECES

115 PCS **FOAM** SERIES **SIZE 4x4** 4X4

- » 1/4" Mini Bits Ratchet
- » 1/4" Flat Bits 25 mm
- » 0.6×3.5, 0.6×4.5, 0.8×4.0, 0.8×5.5, 1.0×5.5, 1.2×6.5, 1.6×8.0
- » 1/4" Flat Bits 50 mm
- » 0.6×3.5, 0.8×4.0, 0.8×5.5, 1.0×5.5, 1.2×6.5
- » 1/4" PH G Bits 25 mm PH2G
- » 1/4" Hex Bits 25 mm
- » 2, 3, 4, 5, 6, 8
- » 1/4" Hex Bits 50 mm
- » 4, 5, 6, 8
- » Flat Screwdriver
- » 0.5×2.5, 0.5×3.0, 0.6×3.5, 0.8×4.0, 1.0×5.5 (×2), 1.2×6.5 (×2), 1.2×8.0, 1.6×10.0
- » PH Screwdriver
- » PH0, PH1, PH2, PH3, PH4
- » PZ Screwdriver
- » PZ0, PZ1 (×2), PZ2, PZ3
- » 1/4" Stubby Bits Driver
- » 1/4" Quick Chuck Bits Driver 217 mm
- » 1/4" T Handle Quick Chuck Bits Driver
- » 1/4" PH Bits 25 mm
- » PH1, PH2, PH3
- » 1/4" PH Bits 50 mm
- » PH1, PH2, PH3
- » 1/4" PZ Bits 25 mm
- » PZ1, PZ2, PZ3
- » 1/4" PZ Bits 50 mm
- » PZ1, PZ2, PZ3
- » 1/4" Ratchet Head Hex/Square Drive
- » 1/4" ROB Bits 25 mm
- » 1, 2, 3
- » 1/4" TPX Bits 25 mm
- » TPX10, TPX15, TPX20, TPX25, TPX27, TPX30, TPX40
- » 1/4" TX Bits 25 mm
- » TX6, TX7, TX8, TX9, TX10, TX15, TX20, TX25, TX27, TX30, TX40
- » 1/4" TX Bits 50 mm
- » TX8, TX10, TX15, TX20, TX25, TX27, TX30



TTEM115N 3060 g £360.90





FLEX HANDLE SET FOAMX4 3 PIECES



- » 1/4" Flex Handle 200 mm
- » 3/8" Flex Handle 300 mm
- » 1/2" Flex Handle 400 mm



TEXBR03

1386 g

£149.90



LONG ARM RATCHET SET FOAMX4 3 PIECES



- » 1/4" Ratchet Long Arm 43 Teeth 200 mm
- » 3/8" Ratchet Long Arm 41 Teeth 300 mm
- » 1/2" Ratchet Long Arm 45 Teeth 400 mm



TEXRL03

1651 g

£152.90



LONG ARM RATCHET FLEX HEAD SET FOAMX4 3 PIECES



- » 1/4" Long Ratchet Flexible Head 43 Teeth 200 mm
- » 3/8" Long Ratchet Flexible Head 41 Teeth 300 mm
- » 1/2" Long Ratchet Flexible Head 45 Teeth 400 mm



TEXRF03

1791 g

£172.90



1/4" SOCKET & BITS SET FOAM1 87 PIECES

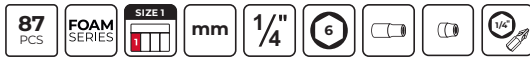

- » Bi-flex Wrench 1/4" Hex x 1/4"
- » 1/4" Flat Bits 25 mm
 - » 0.6x3.5, 0.6x4.5, 0.8x4.0, 0.8x5.5, 1.0x5.5, 1.2x6.5, 1.6x8.0
- » 1/4" PH G Bits 25 mm PH2G
- » 1/4" Hex Bits 25 mm
 - » 2, 3, 4, 5, 6, 8
- » 1/4" Extension Bar 75 mm
- » Hex Socket Adaptor 1/4" Hex - 1/4" 30 mm
- » 1/4" Socket 6 pt AF
 - » 1/4, 5/16, 3/8
- » 1/4" Socket 6 pt Metric
 - » 5.5, 6, 7, 8, 9, 10, 11, 12, 13
- » 1/4" Deep Socket 6 pt Metric
 - » 6, 7, 8, 9, 10, 11, 12, 13
- » 1/4" PH Bits 25 mm
 - » PH1 (x3), PH2 (x6), PH3
- » 1/4" Gearless Palm Ratchet
- » 1/4" PZ Bits 25 mm
 - » PZ1 (x3), PZ2 (x6), PZ3
- » 1/4" ROB Bits 25 mm
 - » 1, 2, 3
- » 1/4" TPX Bits 25 mm
 - » TPX10, TPX15, TPX20 (x2), TPX25 (x2), TPX27, TPX30, TPX40
- » 1/4" TX Bits 25 mm
 - » TX6, TX7, TX8, TX9, TX10, TX15, TX20 (x3), TX25 (x3), TX27, TX30, TX40



TEA1487

1248 g

£162.90

1/4" SOCKET SET 6 PT FOAM2 89 PIECES



- » 1/4" Ratchet 72 Teeth IP5X
- » 1/4" Flat Bits 25 mm
 - » 0.5 x 3.0, 0.8x4.0, 0.8x5.5, 1.4x7.0
- » 1/4" Hex Bits 25 mm
 - » 3, 4, 5, 6, 8, 10
- » 1/4" Hex Bits 25 mm AF
 - » 1/8, 9/64, 5/32, 3/16, 1/4
- » 1/4" Spinner Handle
- » 1/4" Extension Bar 50 mm
- » 1/4" Extension Bar 100 mm
- » 1/4" Universal Joint
- » Hex Socket Adaptor 1/4" Hex - 1/4" 25 mm
- » 1/4" Bit Adaptor Hex Bit Coupler
- » 1/4" Socket 6 pt Metric
 - » 4, 5, 5.5, 6, 7, 8, 9, 10, 11, 12, 13
- » 1/4" Deep Socket 6 pt Metric
 - » 4, 5, 5.5, 6, 7, 8, 9, 10, 12, 13
- » 1/4" TX Bit Socket
 - » 10, 15, 20, 25, 27, 30, 40
- » 1/4" PH Bit Socket
 - » PH0, PH1, PH2, PH3
- » 1/4" Flat Bit Socket
 - » 4, 5.5, 7
- » 1/4" PZ Bit Socket
 - » PZ1, PZ2, PZ3
- » 3/8" Drive Adaptor 3/8"F:1/4"M with 1/4" hole
- » 1/4" PH Bits 25 mm
 - » PH0, PH1, PH2, PH3 (x2)
- » 1/4" PZ Bits 25 mm
 - » PZ0, PZ1, PZ2, PZ3
- » 1/4" XZN/Triple Square Bits 25 mm
 - » 5, 6
- » 1/4" TPX Bits 25 mm
 - » TPX10, TPX15, TPX20, TPX25, TPX27, TPX30, TPX40
- » 1/4" TX Bits 25 mm
 - » TX8, TX10, TX15, TX20, TX25, TX27, TX30, TX40, TX45



TED1489

1600 g

£199.90





3/8" SOCKET SET 6 PT FOAM2 36 PIECES



- » 3/8" Ratchet 72 Teeth IP5X
- » Reducing Adaptor 1/2"F - 3/8"M
- » 3/8" Wobble Extension Bar 75 mm
- » 3/8" Universal Joint
- » 3/8" Socket 6 pt Metric
 - 8, 9, 10, 11, 12, 13, 14, 15, 16, 17, 18, 19, 22
- » 3/8" TX Bit Socket
 - TX10, TX15, TX20, TX25, TX27, TX30, TX40, TX45, TX50
- » 3/8" Hex Bit Socket Metric
 - 3, 4, 5, 5.5, 6, 7, 8, 10, 12
- » 3/8" Rotating Spinner Handle



TED3836

2379 g

£195.90

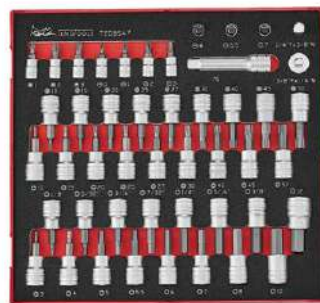

1/4" & 3/8" BIT SOCKET SET FOAM2 47 PIECES

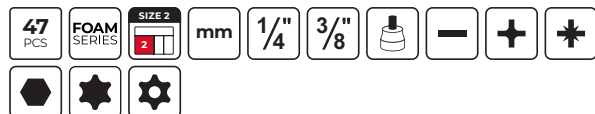

- » Step Up Adaptor 1/4"F - 3/8"M
- » 1/4" PH Bit Socket
 - PH0, PH1, PH2, PH3
- » 1/4" Flat Bit Socket
 - 4, 5.5, 7
- » 1/4" PZ Bit Socket
 - PZ1, PZ2, PZ3
- » 3/8" Extension Bar 75 mm
- » 3/8" Drive Adaptor 3/8"F:1/4"M with 1/4" hole
- » 3/8" Hex Bit Socket AF
 - 1/8, 5/32, 3/16, 7/32, 1/4, 5/16, 3/8
- » 3/8" TPX Bit Socket
 - TPX10, TPX15, TPX20, TPX25, TPX27, TPX30, TPX40, TPX45, TPX50
- » 3/8" TX Bit Socket
 - TX10, TX15, TX20, TX25, TX27, TX30, TX40, TX45, TX50
- » 3/8" Hex Bit Socket Metric
 - 3, 4, 5, 5.5, 6, 7, 8, 10, 12



TEDBS47

2075 g

£220.90



1/2" SOCKET SET 12 PT FOAM2 27 PIECES

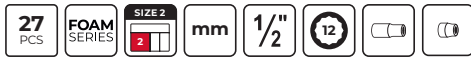

- » 1/2" Ratchet 72 Teeth IP5X
- » 1/2" Extension Bar 63.5 mm
- » 1/2" Extension Bar 150 mm
- » 1/2" Universal Joint
- » 1/2" Socket 12 pt Metric
 - » 10, 11, 12, 13, 14, 15, 16, 17, 18, 19, 22, 24
- » 1/2" Deep Socket 12 pt Metric
 - » 10, 11, 12, 13, 14, 15, 16, 17, 18, 19
- » Step Up Adaptor 3/8" F - 1/2" M



TEDI227 3505 g £224.50

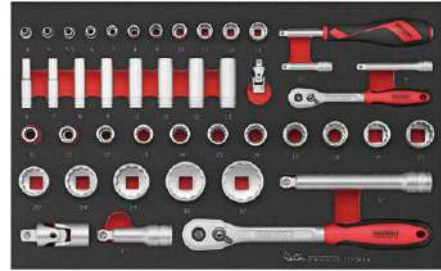

1/4" & 1/2" SOCKET SET FOAM3 44 PIECES

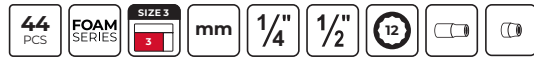

- » 1/2" Ratchet 72 Teeth IP5X
- » 1/4" Ratchet 72 Teeth IP5X
- » 1/2" Wobble Extension Bar 75 mm
- » 1/2" Wobble Extension Bar 150 mm
- » 1/2" Universal Joint
- » 1/2" Socket 12 pt Metric
 - » 10, 11, 12, 13, 14, 15, 16, 17, 18, 19, 21, 22, 24, 27, 30, 32
- » 1/4" Spinner Handle
- » 1/4" Extension Bar 50 mm
- » 1/4" Extension Bar 75 mm
- » 1/4" Universal Joint
- » 1/4" Socket 12 pt Metric
 - » 4, 5, 5.5, 6, 7, 8, 9, 10, 11, 12, 13
- » 1/4" Deep Socket 12 pt Metric
 - » 6, 7, 8, 9, 10, 11, 12, 13



TEFSK44 3166 g £383.90

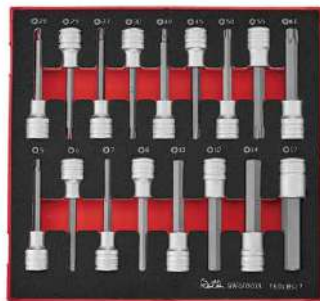

1/2" LONG HEX & TX BIT SOCKET SET FOAM2 17 PIECES



- » 1/2" Long TX Bit Socket
 - » TX20, TX25, TX27, TX30, TX40, TX45, TX50, TX55, TX60
- » 1/2" Long Hex Bit Socket Metric
 - » 5, 6, 7, 8, 10, 12, 14, 17



TEDLBS17 1990 g £172.90





SPANNER & SOCKET SET FOAM3 57 PIECES



- » 1/4" Ratchet 72 Teeth IP5X
- » 3/8" Ratchet 72 Teeth IP5X
- » Combination Spanner Metric
- » 8, 9, 10, 11, 12, 13, 14, 15, 16, 17, 18, 19
- » Reducing Adaptor 1/2"F - 3/8"M
- » 1/4" Extension Bar 50 mm
- » 1/4" Extension Bar 75 mm
- » 1/4" Universal Joint
- » Hex Socket Adaptor 1/4" Hex - 1/4" 30 mm
- » 1/4" Bit Adaptor Hex Bit Coupler
- » 1/4" Socket 6 pt Metric
- » 4, 5, 5.5, 6, 7, 8, 10, 11, 12, 13
- » 1/4" Deep Socket 6 pt Metric
- » 6, 7, 8, 10, 12, 13
- » 3/8" Extension Bar 75 mm
- » 3/8" Extension Bar 150 mm
- » 3/8" Universal Joint
- » 3/8" Drive Adaptor 3/8"F:1/4"M with 1/4" hole
- » 3/8" Spark Plug Socket
- » 16, 21
- » 3/8" Bit Adaptor Hex bit coupler 1/4" Hex
- » 3/8" Socket 6 pt Metric
- » 8, 9, 10, 11, 12, 13, 14, 15, 16, 17, 18, 19, 21, 22



TEFSK57

3395 g

£367.90



EXTENSION BARS SET FOAMX4 13 PIECES



- » 1/2" Wobble Extension Bar 75 mm
- » 1/2" Extension Bar 500 mm
- » 1/2" Universal Joint
- » 1/4" Extension Bar 150 mm
- » 1/4" Extension Bar 305 mm
- » 1/4" Universal Joint
- » 3/8" Wobble Extension Bar 75 mm
- » 3/8" Extension Bar 500 mm
- » 3/8" Universal Joint
- » 3/8" Drive Adaptor 3/8"F:1/4"M with 1/4" hole
- » Hex Mini Screwdriver
- » 2, 2.5
- » T Bar Handle Grip



TEXEXT13

2041 g

£167.90

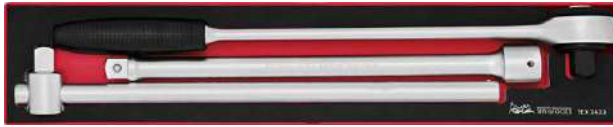

3/4" RATCHET & ACCESSORIES SET FOAMX4 3 PIECES



☰		
»	3/4" Ratchet Heavy Duty 72 Teeth	
»	3/4" Extension Bar 400 mm	
»	3/4" Sliding T Bar	
TEX3403	4955 g	£314.90



3/4" SOCKET SET 6 PT FOAMX4 10 PIECES

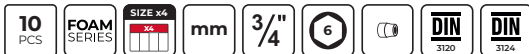

☰		
»	22, 24, 27, 30, 32, 36, 38, 41, 46, 50	
TEX3410	4211 g	£217.90

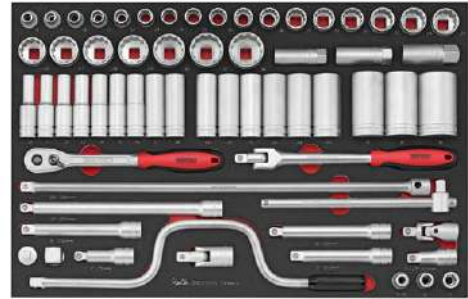

1/2" SOCKET SET 12 PT FOAM4X4 63 PIECES



☰		
»	1/2" Ratchet 72 Teeth IP5X	
»	1/2" Flex Handle 265 mm	
»	1/2" Speed Brace	
»	1/2" Extension Bar 63.5 mm	
»	1/2" Wobble Extension Bar 75 mm	
»	1/2" Extension Bar 125 mm	
»	1/2" Wobble Extension Bar 150 mm	
»	1/2" Wobble Extension Bar 255 mm	
»	1/2" Extension Bar 150 mm	
»	1/2" Extension Bar 500 mm	
»	1/2" Universal Joint	
»	Reducing Adaptor 1/2"F - 3/8"M	
»	Step Up Adaptor 1/2"F - 3/4"M	
»	1/2" Spark Plug Socket	
»	16, 18, 21	
»	1/2" Sliding T Bar	
»	1/2" Bit Adaptor 5/16" Hex	
»	1/2" Bit Adaptor 10 mm	
»	1/2" Bit Adaptor 12 mm	
»	1/2" Flex Head Adaptor	
»	1/2" Socket 12 pt Metric	
»	8, 9, 10, 11, 12, 13, 14, 15, 16, 17, 18, 19, 20, 21, 22, 24, 25, 26, 27, 28, 29, 30, 32, 34	
»	1/2" Deep Socket 12 pt Metric	
»	10, 11, 12, 13, 14, 15, 16, 17, 18, 19, 20, 21, 22, 24, 27, 30, 32, 36	
TTESK63	10530 g	£724.90





3/4" SOCKET & SPANNER SET 25 PIECES

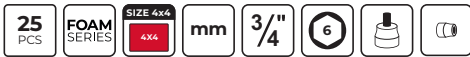

- » Combination Spanner Metric
34, 36, 38
- » 3/4" Ratchet Heavy Duty 72 Teeth
- » 3/4" Extension Bar 200 mm
- » 3/4" Flex Handle 480 mm
- » 3/4" Socket 6 pt Metric
19, 21, 22, 24, 26, 27, 30, 32, 33, 34, 36, 38, 41, 46, 50
- » 3/4" Hex Bit Socket Metric
14, 17, 19, 22



TTESK25

13750 g

£872.90

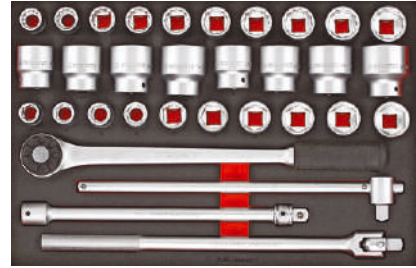

3/4" SOCKET SET FOAM4X4 32 PIECES



- » 3/4" Ratchet Heavy Duty 72 Teeth
- » 3/4" Extension Bar Safety Lock 400 mm
- » 3/4" Sliding T Bar Safety Lock
- » 3/4" Flex Handle Safety Lock 480 mm
- » 3/4" Socket 12 pt AF
7/8, 15/16, 1, 1 1/16, 1 1/8, 1 3/16, 1 1/4, 1 5/16, 1 3/8, 1 7/16, 1 1/2, 1 5/8, 1 3/4, 1 7/8
- » 3/4" Socket 6 pt Metric
19, 21, 22, 24, 27, 30, 32, 33, 34, 36, 38, 41, 46, 50



TTESK32

17022 g

£814.90



1/4" & 3/8" SOCKET SET FOAM4X4 86 PIECES

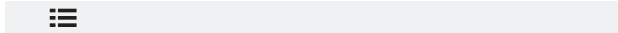
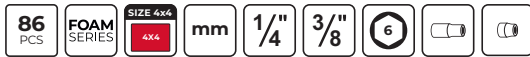

- » 1/4" Ratchet 72 Teeth IP5X
- » 3/8" Ratchet 72 Teeth IP5X
- » 1/4" Spinner Handle
- » 1/4" Extension Bar 50 mm
- » 1/4" Extension Bar 100 mm
- » 1/4" Extension Bar 150 mm
- » 1/4" Extension Bar 75 mm
- » 1/4" Extension Bar 305 mm
- » 1/4" Universal Joint
- » Step Up Adaptor 1/4"F - 3/8"M
- » 1/4" Sliding T Bar
- » 1/4" Bit Adaptor Hex Bit Coupler
- » 1/4" Socket 6 pt Metric
 - » 4, 4.5, 5, 5.5, 6, 7, 8, 9, 10, 11, 12, 13
- » 1/4" Deep Socket 6 pt Metric
 - » 4, 5, 5.5, 6, 7, 8, 9, 10, 11, 12, 13
- » 3/8" Speed Brace
- » 3/8" Spinner Handle
- » 3/8" Extension Bar 75 mm
- » 3/8" Wobble Extension Bar 75 mm
- » 3/8" Extension Bar 150 mm
- » 3/8" Wobble Extension Bar 150 mm
- » 3/8" Extension Bar 254 mm
- » 3/8" Wobble Extension Bar 255 mm
- » 3/8" Extension Bar 125 mm
- » 3/8" Extension Bar 500 mm
- » 3/8" Universal Joint
- » 3/8" Drive Adaptor 3/8"F:1/4"M with 1/4" hole
- » Step Up Adaptor 3/8"F - 1/2"M
- » 3/8" Spark Plug Socket
 - » 16, 18, 21
- » 3/8" Bit Adaptor Hex bit coupler 1/4" Hex
- » 3/8" Socket 6 pt Metric
 - » 7, 8, 9, 10, 11, 12, 13, 14, 15, 16, 17, 18, 19, 20, 21, 22
- » 3/8" Deep Socket 6 pt Metric
 - » 7, 8, 9, 10, 11, 12, 13, 14, 15, 16, 17, 18, 19, 20, 21, 22
- » 3/8" Rotating Spinner Handle



TTESK86

6050 g

£627.90

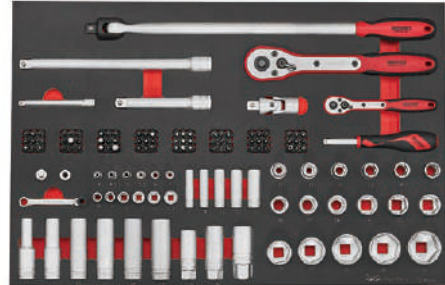

1/4" & 1/2" SOCKET SET 6 PT FOAM4X4 126 PIECES

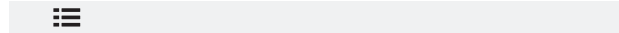
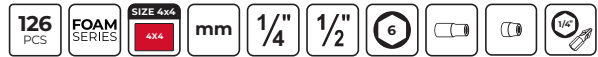

- » 1/2" Ratchet FRP 45 Teeth
- » 1/2" Breaker Bar 450 mm DIN3122
- » 1/4" Mini Bits Ratchet
- » 1/4" Ratchet FRP 45 Teeth
- » 1/4" Flat Bits 25 mm
 - » 0.6x3.5, 0.6x4.5, 0.8x4.0 (x2), 0.8x5.5, 1.0x5.5, 1.2x6.5, 1.6x8.0
- » 1/4" PH G Bits 25 mm PH2G
- » 1/4" Hex Bits 25 mm
 - » 2, 3, 4, 5, 6, 8
- » 1/2" Extension Bar 125 mm
- » 1/2" Extension Bar 255 mm
- » 1/2" Universal Joint
- » 1/2" Spark Plug Socket
 - » 16, 18, 21
- » 1/2" Socket 6 pt Metric
 - » 10, 11, 12, 13, 14, 15, 16, 17, 18, 19, 20, 21, 24, 27, 30, 32, 34
- » 1/2" Deep Socket 12 pt Metric
 - » 10, 13, 16, 17, 18, 19
- » 1/4" Spinner Handle
- » 1/4" Extension Bar 100 mm
- » 1/4" Universal Joint
- » Hex Socket Adaptor 1/4" Hex - 1/4" 25 mm
- » 1/4" Bit Adaptor Hex Bit Coupler
- » 1/4" Socket 6 pt Metric
 - » 4, 4.5, 5, 5.5, 6, 7, 8, 9, 10, 11, 12, 13
- » 1/4" Deep Socket 6 pt Metric
 - » 7, 8, 10, 11, 13
- » 1/4" PH Bits 25 mm
 - » PH1 (x4), PH2 (x7), PH3 (x2)
- » 1/4" PZ Bits 25 mm
 - » PZ1 (x4), PZ2 (x7), PZ3
- » 1/4" ROB Bits 25 mm
 - » 1, 2, 3
- » 1/4" TPX Bits 25 mm
 - » TPX10, TPX15, TPX20 (x2), TPX25 (x2), TPX27, TPX30, TPX40
- » 1/4" TX Bits 25 mm
 - » TX6, TX7, TX8, TX9, TX10, TX15, TX20 (x3), TX25 (x3), TX27, TX30 (x2), TX40



TTESK126

6230 g

£513.90



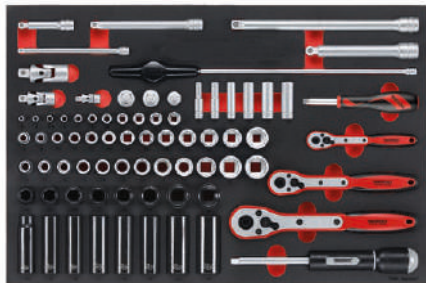

1/4", 3/8" & 1/2" SOCKET SET FOAM4X4 76 PIECES

76 PCS
FOAM SERIES
SIZE 4x4 4x4
mm
1/4"
3/8"
1/2"
6
12



- » 1/2" Ratchet FRP 45 Teeth
- » 1/4" Ratchet FRP 45 Teeth
- » 3/8" Ratchet FRP 45 Teeth
- » 1/2" Impact Socket ANSI Metric
13, 15, 16, 17, 18, 19, 22, 24
- » 1/2" Deep Impact Socket ANSI Metric
13, 15, 16, 17, 18, 19, 22, 24
- » 1/2" Wobble Extension Bar 150 mm
- » 1/2" Extension Bar 255 mm
- » 1/2" Universal Joint
- » Reducing Adaptor 1/2"F - 3/8"M
- » 1/2" Socket 12 pt Metric
10, 11, 12, 13, 14, 15, 16, 17, 18, 19, 22, 24
- » 1/4" Spinner Handle
- » 1/4" Extension Bar 150 mm
- » 1/4" Extension Bar 305 mm
- » 1/4" Universal Joint
- » 1/4" Socket 6 pt Metric
4, 5, 5.5, 6, 7, 8, 9, 10, 11, 12, 13
- » 1/4" Deep Socket 6 pt Metric
6, 7, 8, 10, 12, 13
- » 3/8" Wobble Extension Bar 75 mm
- » 3/8" Extension Bar 150 mm
- » 3/8" Universal Joint
- » 3/8" Drive Adaptor 3/8"F:1/4"M with 1/4" hole
- » Step Up Adaptor 3/8"F - 1/2"M
- » 3/8" Socket 6 pt Metric
8, 9, 10, 11, 12, 13, 14, 15, 16, 17, 18, 19, 22
- » 3/8" Rotating Spinner Handle
- » T Bar Handle Grip



TTESK77

6750 g

£629.90

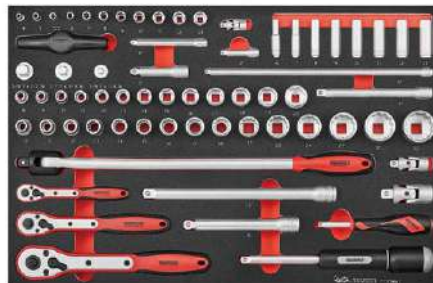

1/4", 3/8" & 1/2" SOCKET SET FOAM4X4 67 PIECES

67 PCS
FOAM SERIES
SIZE 4x4 4x4
mm
1/4"
3/8"
1/2"
6
12



- » 1/2" Ratchet FRP 45 Teeth
- » 1/2" Breaker Bar 450 mm DIN3122
- » 1/4" Ratchet FRP 45 Teeth
- » 3/8" Ratchet FRP 45 Teeth
- » 1/2" Wobble Extension Bar 150 mm
- » 1/2" Extension Bar 255 mm
- » 1/2" Universal Joint
- » Reducing Adaptor 1/2"F - 3/8"M
- » 1/2" Socket 12 pt Metric
10, 11, 12, 13, 14, 15, 16, 17, 18, 19, 22, 24, 27, 30, 32
- » 1/4" Spinner Handle
- » 1/4" Extension Bar 50 mm
- » 1/4" Extension Bar 100 mm
- » 1/4" Extension Bar 305 mm
- » 1/4" Universal Joint
- » 1/4" Socket 6 pt Metric
4, 5, 5.5, 6, 7, 8, 9, 10, 11, 12, 13
- » 1/4" Deep Socket 6 pt Metric
6, 7, 8, 9, 10, 11, 12, 13
- » 3/8" Wobble Extension Bar 75 mm
- » 3/8" Extension Bar 150 mm
- » 3/8" Universal Joint
- » 3/8" Drive Adaptor 3/8"F:1/4"M with 1/4" hole
- » Step Up Adaptor 3/8"F - 1/2"M
- » 3/8" Socket 6 pt Metric
8, 9, 10, 11, 12, 13, 14, 15, 16, 17, 18, 19, 22
- » 3/8" Rotating Spinner Handle
- » T Bar Handle Grip



TTESK67

5980 g

£545.90

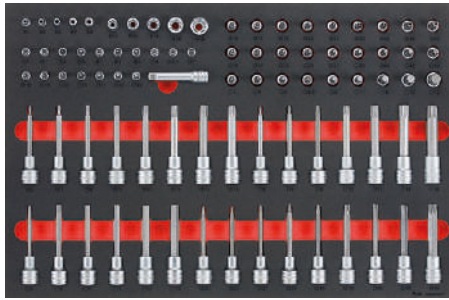

1/4", 3/8" & 1/2" SOCKET SET FOAM4X4 85 PIECES



- » 1/2" Long TX Bit Socket
TX20, TX25, TX27, TX30, TX40, TX45, TX50, TX55, TX60
- » 1/2" Long Hex Bit Socket Metric
5, 6, 7, 8, 10, 12
- » 1/2" Long Ribe® Bit Socket
4, 5, 6, 8, 10, 11, 12, 13
- » 1/2" Long XZN/Triple Square Bit Socket
5, 6, 8, 10, 12, 14, 16
- » 1/4" TX-E Socket
E4, E5, E6, E7, E8
- » 1/4" TX Bit Socket
10, 15, 20, 25, 27, 30, 40
- » 1/4" PH Bit Socket
PH0, PH1, PH2, PH3
- » 1/4" Flat Bit Socket
4, 5.5, 7
- » 1/4" PZ Bit Socket
PZ1, PZ2, PZ3
- » 3/8" Extension Bar 75 mm
- » 3/8" TX-E Socket
E10, E12, E14, E16, E18
- » 3/8" TPX Bit Socket
TPX10, TPX15, TPX20, TPX25, TPX27, TPX30, TPX40, TPX45, TPX50
- » 3/8" TX Bit Socket
TX10, TX15, TX20, TX25, TX27, TX30, TX40, TX45, TX50
- » 3/8" Hex Bit Socket Metric
3, 4, 5, 5.5, 6, 7, 8, 10, 12



TTESK85



4010 g

£554.90

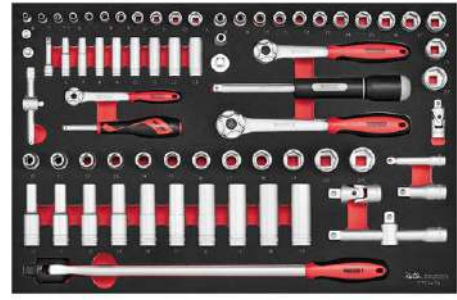

1/4", 3/8" & 1/2" SOCKET SET FOAM4X4 73 PIECES

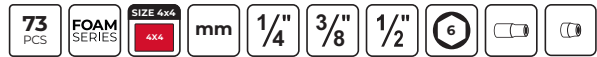

- » 1/2" Breaker Bar 450 mm DIN3122
- » 1/4" Ratchet 72 Teeth
- » 3/8" Ratchet 72 Teeth
- » 1/2" Extension Bar 63.5 mm
- » 1/2" Extension Bar 150 mm
- » 1/2" Universal Joint
- » Reducing Adaptor 1/2"F - 3/8"M
- » 1/2" Socket 6 pt Metric
10, 11, 12, 13, 14, 15, 16, 17, 18, 19, 22, 24
- » 1/2" Deep Socket 12 pt Metric
10, 11, 12, 13, 14, 15, 16, 17, 18, 19
- » 1/4" Spinner Handle
- » 1/4" Extension Bar 50 mm
- » 1/4" Extension Bar 100 mm
- » 1/4" Universal Joint
- » 1/4" Magnetic pick up socket
- » 1/4" Socket 6 pt Metric
4, 5, 5.5, 6, 7, 8, 9, 10, 11, 12, 13
- » 1/4" Deep Socket 6 pt Metric
6, 7, 8, 9, 10, 11, 12, 13
- » 3/8" Wobble Extension Bar 75 mm
- » 3/8" Universal Joint
- » 3/8" Drive Adaptor 3/8"F:1/4"M with 1/4" hole
- » Step Up Adaptor 3/8"F - 1/2"M
- » 3/8" Bit Adaptor Hex bit coupler 1/4" Hex
- » 3/8" Socket 6 pt Metric
8, 9, 10, 11, 12, 13, 14, 15, 16, 17, 18, 19, 22
- » 3/8" Rotating Spinner Handle



TTESK73



6170 g

£589.00





1/2" IMPACT SOCKET SET ANSI FOAM2 21 PIECES



- » 1/2" Impact Extension Bar DIN (F) ANSI (M) 75 mm
- » 1/2" Impact Extension Bar DIN (F) ANSI (M) 250 mm
- » 1/2" Impact Universal Joint DIN (F) ANSI (M)
- » Impact Step Up Adaptor 1/2"F (DIN) - 3/4"M (ANSI)
- » 1/2" Impact Socket ANSI Metric
- » 13, 15, 16, 17, 18, 19, 22, 24
- » 1/2" Deep Impact Socket ANSI Metric
- » 13, 15, 16, 17, 18, 19, 22, 24
- » Impact Step Up Adaptor 3/8"F (DIN) - 1/2"M (ANSI)



TED9121

4197 g

£269.90



1/2" DEEP IMPACT SOCKET SET AF DIN FOAM1 14 PIECES



- » 1/2" Deep Impact Socket DIN AF
- » 7/16, 1/2, 9/16, 5/8, 11/16, 3/4, 13/16, 7/8, 15/16, 1
- » Retaining Ring
- » 19x4, 24x4
- » Retaining Pin
- » 3x20, 3x25



TEA9214LAF

2317 g

£154.90



1/2" IMPACT SOCKET SET AF DIN FOAM1 16 PIECES



- » 1/2" Impact Socket DIN AF
- » 3/8, 7/16, 1/2, 9/16, 5/8, 3/4, 13/16, 7/8, 1, 1 1/16, 1 1/8, 1 1/4
- » Retaining Ring
- » 19x4, 24x4
- » Retaining Pin
- » 3x20, 3x25



TEA9216AF

1650 g

£134.20

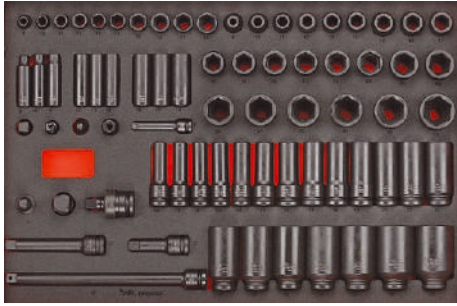

3/8" & 1/2" IMPACT SOCKET SET FOAM4X4 73 PIECES

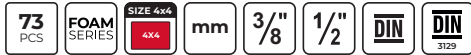

- » 1/2" Impact Extension Bar DIN 75 mm
- » 1/2" Impact Extension Bar DIN 125 mm
- » 1/2" Impact Extension Bar DIN 250 mm
- » 1/2" Impact Universal Joint DIN
- » Impact Reducing Adaptor 1/2" F - 3/8" M DIN
- » Impact Step Up Adaptor 1/2" F - 3/4" M DIN
- » 1/2" Impact Coupler Adaptor 5/16" Hex
- » 1/2" Impact Socket DIN Metric
 - » 8, 10, 11, 12, 13, 14, 15, 16, 17, 18, 19, 20, 21, 22, 23, 24, 25, 26, 27, 28, 29, 30, 32
- » 1/2" Deep Impact Socket DIN Metric
 - » 10, 11, 12, 13, 14, 15, 16, 17, 18, 19, 21, 22, 24, 27, 28, 29, 30, 32, 35, 36
- » 3/8" Impact Extension Bar DIN (F) ANSI (M) 75 mm
- » Impact Reducing Adaptor 3/8" F - 1/4" M DIN
- » Impact Step Up Adaptor 3/8" F - 1/2" M DIN
- » 3/8" Impact Coupler Adaptor 1/4" Hex
- » 3/8" Impact Socket ANSI Metric
 - » 8, 10, 11, 12, 13, 14, 15, 16, 17, 19
- » 3/8" Deep Impact Socket ANSI Metric
 - » 8, 10, 11, 12, 13, 14, 16, 17, 19
- » Retaining Ring
 - » 19x4, 24x4
- » Retaining Pin
 - » 3x20, 3x25



TTEISK73



12090 g

£863.90



1/2" IMPACT SOCKET SET FOAM4X4 103 PIECES



- » 1/2" Impact Extension Bar DIN 75 mm
- » 1/2" Impact Extension Bar DIN 125 mm
- » 1/2" Impact Extension Bar DIN 250 mm
- » 1/2" Impact Universal Joint DIN
- » Impact Reducing Adaptor 1/2" F - 3/8" M DIN
- » Impact Step Up Adaptor 1/2" F - 3/4" M DIN
- » 1/2" Impact Coupler Adaptor 5/16" Hex
- » 1/2" Impact Socket DIN Metric
 - » 8, 10, 11, 12, 13, 14, 15, 16, 17, 18, 19, 21, 22, 24, 27, 28, 29, 30, 32
- » 1/2" Deep Impact Socket DIN Metric
 - » 10, 11, 12, 13, 14, 15, 16, 17, 18, 19, 21, 22, 24, 27, 28, 29, 30, 32, 35, 36
- » 1/4" PH G Impact Bits 30 mm PH2G
- » 1/4" Hex Impact Bits 30 mm
 - » 3, 4, 5, 6
- » 1/4" Impact Driver
- » 1/4" Magnetic Impact Bit Holder 60 mm
- » 1/4" Impact Nut Setter
 - » 1/4, 7, 8, 10, 13
- » Retaining Ring
 - » 19x4, 24x4
- » Retaining Pin
 - » 3x20, 3x25
- » 1/4" PH Impact Bits 30 mm
 - » PH1, PH2, PH3
- » 1/4" PZ Impact Bits 30 mm
 - » PZ1, PZ2, PZ3
- » 1/4" Quick Chuck Impact Bit Holder 60 mm
- » 1/4" ROB Impact Bits 30 mm
 - » 1, 2
- » 1/4" TX Impact Bits 30 mm
 - » TX10, TX15, TX20, TX25, TX27, TX30, TX40



TTEISK103



10650 g

£879.90





3/4" IMPACT SOCKET SET DIN FOAM4X4 33 PIECES



- » 3/4" Impact Extension Bar DIN 175 mm
- » 3/4" Impact Universal Joint DIN
- » Impact Reducing Adaptor 3/4"F - 1/2"M DIN
- » Impact Step Up Adaptor 3/4"F - 1"M DIN
- » 3/4" Impact Socket DIN Metric
 - » 19, 21, 22, 23, 24, 27, 28, 30, 32, 33, 34, 36, 38, 41, 46
- » 3/4" Deep Impact Socket DIN Metric
 - » 19, 21, 22, 23, 24, 27, 30, 32, 33, 34, 36, 38, 41, 46
- » Retaining Ring 36 x 5.0 mm
- » Retaining Pin 4 x 35 mm



TTEISK33

20672 g

£1,029.90



TORQUE SCREWDRIVER SET FOAM2 95 PIECES



- » 1/4" Torque Screwdriver 1-5Nm
- » 5/16" Hex Impact Driver Bits
 - » 4, 5, 6, 8
- » 1/2" Impact Coupler Adaptor 5/16" Hex
- » 5/16" PH Impact Driver Bits
 - » PH1, PH2, PH3, PH4
- » 5/16" Flat Impact Driver Bits
 - » 6, 8, 10, 12
- » 5/16" TX Impact Driver Bits
 - » TX30, TX40, TX45, TX50, TX55
- » Hex Socket Adaptor 5/16" Hex - 3/8"
- » 1/4" Quick Chuck Bit Holder 35 mm
- » 1/4" Flat Bits 25 mm
 - » 0.6x3.5, 0.6x4.5, 0.8x4.0, 0.8x5.5, 1.0x5.5 (*2), 1.2x6.5, 1.4x7.0, 1.6x8.0
- » 1/4" PH G Bits 25 mm PH2G
- » 1/4" Hex Bits 25 mm
 - » 2, 3, 4, 5, 6, 8
- » 1/2" Impact Driver Heavy Duty
- » Hex Socket Adaptor 1/4" Hex - 1/4" 25 mm
- » 1/4" Sliding T Bar
- » 1/4" Ratcheting Bits Driver Set
 - » 1/4" Flat Bits 25 mm
 - » 1.0x5.5, 1.4x7.0
 - » Hex Socket Adaptor 1/4" Hex - 1/4" 25 mm
- » 1/4" PH Bits 25 mm
 - » PH1, PH2
- » 1/4" PZ Bits 25 mm
 - » PZ1, PZ2
- » 1/4" PH Bits 25 mm
 - » PH1 (*4), PH2 (*7), PH3
- » 1/4" PZ Bits 25 mm
 - » PZ1 (*4), PZ2 (*7), PZ3
- » 1/4" ROB Bits 25 mm
 - » 1, 2, 3
- » 1/4" TPX Bits 25 mm
 - » TPX10, TPX15, TPX20 (*2), TPX25 (*2), TPX27, TPX30, TPX40
- » 1/4" TX Bits 25 mm
 - » TX6, TX7, TX8, TX9, TX10, TX15, TX20 (*3), TX25 (*3), TX27, TX30, TX40



TEDSD14

2128 g

£283.90



TORQUE SCREWDRIVER SET FOAM1 38 PIECES



☰		
»	1/4" Torque Screwdriver 1-5Nm	
»	1/4" Flat Bits 25 mm	
»	0.5 x 3.0, 0.6 x 4.5, 0.8 x 5.5, 1.2 x 6.5	
»	1/4" PH G Bits 25 mm PH2G	
»	1/4" Hex Bits 25 mm	
»	2, 3, 4, 5, 6	
»	Hex Socket Adaptor 1/4" Hex - 1/4" 30 mm	
»	1/4" PH Bits 25 mm	
»	PH0, PH1, PH2, PH3	
»	1/4" PZ Bits 25 mm	
»	PZ0, PZ1, PZ2, PZ3	
»	1/4" ROB Bits 25 mm	
»	1, 2, 3	
»	1/4" TPX Bits 25 mm	
»	TPX10, TPX15, TPX20, TPX30, TPX40	
»	1/4" TX Bits 25 mm	
»	TX8, TX9, TX10, TX15, TX20, TX25, TX27, TX30, TX40	
<hr/>		
TEASD38	684 g	£164.90



INSULATED TORQUE SCREWDRIVER SET FOAM1 9 PIECES



☰		
»	Insulated Torque Screwdriver 1-5Nm	
»	Interchangeable Blade Insulated Screwdriver	
»	3, 4, 5.5, 6.5, PH1, PH2, PZ1, PZ2	
<hr/>		
TEAVSD09	610 g	£211.90



1/4" TORQUE SET FOAMX2 2 PIECES



☰		
»	1/4" Torque Screwdriver 1-5Nm	
»	1/4" Torque Wrench 5 - 25Nm	
<hr/>		
TEZSD02	1024 g	£242.90





3/8" & 1/2" TORQUE WRENCH SET FOAMX4 2 PIECES



» 3/8" Torque Wrench 20 - 110Nm		
» 1/2" Torque Wrench 40 - 210Nm		
TEX1238	2584 g	£249.90



COMBINATION SPANNER SET FOAM2 15 PIECES



» 5.5, 6, 7, 8, 9, 10, 11, 12, 13, 14, 15, 16, 17, 18, 19		
TED6515	1504 g	£163.90



COMBINATION SPANNER SET ANTI SLIP FOAM2 12 PIECES



» 8, 9, 10, 11, 12, 13, 14, 15, 16, 17, 18, 19		
TED8012	1479 g	£174.90



COMBINATION SPANNER SET FOAMX4 7 PIECES



» 20, 21, 22, 24, 27, 30, 32		
TEX2032	2655 g	£174.90



RATCHETING COMBINATION SPANNER SET R FOAM2 12 PIECES



☰		
»	8, 9, 10, 11, 12, 13, 14, 15, 16, 17, 18, 19	
TED6512R	1865 g	£359.90

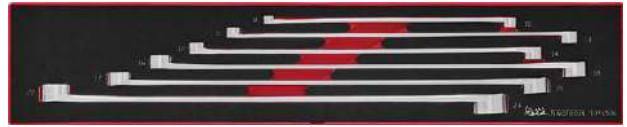

LONG DOUBLE RING SPANNER SET FOAMX4 6 PIECES



☰		
»	8×10, 11×13, 12×14, 16×18, 17×19, 22×24	
TEXFLS06	1785 g	£293.90

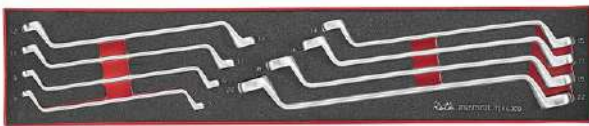

DOUBLE RING SPANNER SET FOAMX4 8 PIECES



☰		
»	6×7, 8×9, 10×11, 12×13, 14×15, 16×17, 18×19, 20×22	
TEX6308	1645 g	£179.90

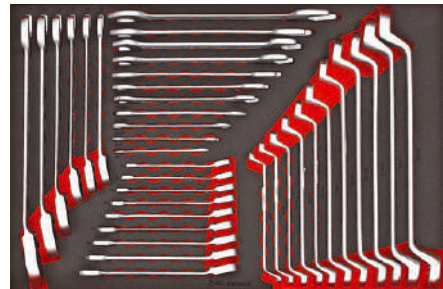

SPANNER SET FOAM4X4 37 PIECES



☰		
»	Ratcheting Combination Spanner Metric R	
»	8, 9, 10, 11, 12, 13, 14, 15, 16, 17, 18, 19, 22, 24, 27	
»	Double Open Ended Spanner Metric	
»	6×7, 8×9, 10×11, 12×13, 14×15, 16×17, 18×19, 20×22, 21×23, 24×27, 30×32	
»	Double Ring Spanner Metric	
»	6×7, 8×9, 10×11, 12×13, 14×15, 16×17, 18×19, 20×22, 21×23, 24×27, 30×32	
TTESP37	7370 g	£1,009.00





SPANNER & FILE SET FOAM4X4 32 PIECES

32 PCS
FOAM SERIES
SIZE 4x4 4x4
mm

- » Combination Spanner Metric
- » 8, 9, 10, 11, 12, 13, 14, 15, 16, 17, 18, 19, 20, 21, 22, 24, 27, 30, 32
- » Ratcheting Combination Spanner Metric RS
- » 8, 10, 11, 12, 13, 14, 17, 19
- » Hand File 250 mm Flat
- » Hand File 250 mm Flat Tapered
- » Hand File 250 mm Half round
- » Hand File 250 mm Round
- » Hand File 250 mm Triangular

TTEX32
5150 g
£540.90



COMBINATION SPANNER SET FOAM4X4 31 PIECES

31 PCS
FOAM SERIES
SIZE 4x4 4x4
mm
DIN 3113A

- » Combination Spanner Metric
- » 8, 9, 10, 11, 12, 13, 14, 15, 16, 17, 18, 19, 20, 21, 22, 24, 27, 30, 32
- » Ratcheting Combination Spanner Metric R
- » 8, 9, 10, 11, 12, 13, 14, 15, 16, 17, 18, 19

TTESP31A
4870 g
£649.90

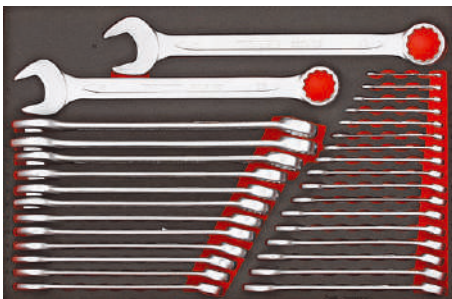

COMBINATION SPANNER SET FOAM4X4 31 PIECES

31 PCS
FOAM SERIES
SIZE 4x4 4x4
mm
DIN 3113A

- » 5.5, 6, 7, 8, 9, 10, 11, 12, 13, 14, 15, 16, 17, 18, 19, 20, 21, 22, 23, 24, 25, 26, 27, 28, 29, 30, 32, 33, 34, 36, 38

TTESP31
8220 g
£641.90



SPANNER SET FOAM4X4 15 PIECES

15 PCS
FOAM SERIES
SIZE 4x4 4x4
mm

- » Adjustable Wrench 150 mm
- » Adjustable Wrench 250 mm
- » Curved Jaw Power Grip Plier 235 mm
- » Combination Spanner Metric
- » 8, 9, 10, 11, 12, 13, 14, 15, 16, 17, 18, 19

TTESP15
2340 g
£226.00



SOCKET & COMBINATION SPANNER SET AF FOAM4X4 62 PIECES

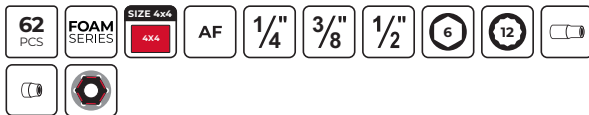

- » Combination Spanner AF
- » 5/16, 3/8, 7/16, 1/2, 9/16, 5/8, 11/16, 3/4, 13/16, 7/8, 15/16, 1, 1 1/16, 1 1/8, 1 1/4
- » 1/2" Socket 12 pt AF
- » 3/8, 7/16, 1/2, 9/16, 5/8, 11/16, 3/4, 13/16, 7/8, 15/16, 1, 1 1/16, 1 1/8, 1 3/16, 1 1/4
- » 1/4" Socket 6 pt AF
- » 3/16, 7/32, 1/4, 9/32, 5/16, 11/32, 3/8, 7/16, 1/2
- » 1/4" Deep Socket 6 pt AF
- » 3/16, 7/32, 1/4, 9/32, 5/16, 11/32, 3/8, 7/16, 1/2
- » 3/8" Socket 6 pt AF
- » 3/8, 7/16, 1/2, 9/16, 5/8, 11/16, 3/4
- » 3/8" Deep Socket 6 pt AF
- » 3/8, 7/16, 1/2, 9/16, 5/8, 11/16, 3/4



TTEAF62

5650 g

£509.90



ADJUSTABLE WRENCH SET FOAM2 4 PIECES



- » Adjustable Wrench TPR Grip 150 mm
- » Adjustable Wrench TPR Grip 200 mm
- » Adjustable Wrench Wide Jaw 200 mm
- » Adjustable Wrench TPR Grip 250 mm



TEDADJ4

1522 g

£176.90



DOUBLE FLEX WRENCH SET FOAM2 7 PIECES



- » Double Flex Wrench Metric
- » 8×9, 10×11, 12×13, 14×15, 16×17, 18×19
- » Bi-flex Wrench 1/4" Hex × 1/4"



TEDDF7

1914 g

£212.90





SCREWDRIVER SET FLAT FOAM1 4 PIECES



» 0.5x3.0, 0.8x4.0, 1.0x5.5, 1.2x6.5



TEAMD04N

456 g

£46.50



SCREWDRIVER SET TX 4 FOAM1 PIECES



» TX10, TX15, TX20, TX25



TEAMD04TXN

518 g

£51.90



SCREWDRIVER SET PH/PZ FOAM1 4 PIECES



» PH Screwdriver
 » PH0, PH1, PH2
 » PZ Screwdriver PZ1 x 75 mm M



TEAMD04N1

472 g

£47.50



SCREWDRIVER SET MIXED FOAM2 11 PIECES



» Flat Screwdriver
 » 0.6x3.5, 1.0x5.5 (x2), 1.2x6.5 (x2)
 » PH Screwdriver
 » PH0, PH1, PH2 (x2)
 » PZ Screwdriver
 » PZ1, PZ2



TED911N

1138 g

£121.90



SCREWDRIVER SET FLAT & PH FOAMX4 5 PIECES



- » Flat Screwdriver
1.0×5.5, 1.2×6.5, 1.2×8.0, 1.6×10.0
- » PH Screwdriver PH3 × 150 mm XL Hex Shaft

TEX915N	1087 g	£101.90



SCREWDRIVER SET TX FOAM2 9 PIECES



- » TX6, TX8, TX9, TX10, TX15, TX20, TX25, TX27, TX30

TED909TXN	1014 g	£114.90



STUBBY SCREWDRIVER SET FOAMX2 6 PIECES



- » Flat Screwdriver 1.2 × 6.5 × 38 mm XS
- » PH Screwdriver
PH1, PH2
- » PZ Screwdriver
PZ1, PZ2
- » 1/4" Stubby Bits Driver

TEZMD06	454 g	£60.50

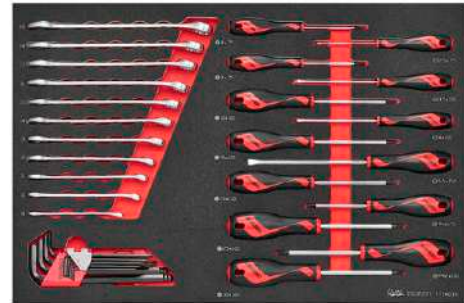

SCREWDRIVER & SPANNER SET FOAM4X4 33 PIECES



- » Ball Point Hex Key Metric
1.5, 2, 2.5, 3, 4, 5, 6, 8, 10
- » Combination Spanner Metric
8, 10, 11, 12, 13, 14, 15, 16, 17, 18, 19
- » TPX Screwdriver
TPX10, TPX15, TPX20, TPX25, TPX30
- » TX Screwdriver
TX8, TX9
- » Flat Screwdriver
0.5×2.5, 0.6×3.5, 0.8×4.0, 1.0×5.5
- » PH Screwdriver
PH1, PH2

TTEMD33	2290 g	£286.90





SCREWDRIVER SET MIXED FOAM4X4 122 PIECES



- » 1/4" Flat Bits 25 mm
- » 0.6×3.5, 0.6×4.5, 0.8×4.0 (×2), 0.8×5.5, 1.0×5.5 (×2), 1.2×6.5, 1.4×7.0, 1.6×8.0
- » 1/4" Flat Bits 50 mm 0.6×3.5, 0.8×4.0, 0.8×5.5, 1.0×5.5, 1.2×6.5
- » 1/4" PH G Bits 25 mm PH2G
- » 1/4" Hex Bits 25 mm 2, 3, 4, 5, 6, 8
- » 1/4" Hex Bits 50 mm 4, 5, 6, 8
- » Hex Socket Adaptor 1/4" Hex - 1/4" 25 mm
- » Flat Screwdriver 0.5×2.5, 0.5×3.0, 0.6×3.5, 0.8×4.0, 1.0×5.5 (×2), 1.2×6.5 (×3), 1.2×8.0, 1.6×10.0
- » PH Screwdriver PH0, PH1 (×2), PH2 (×2), PH3, PH4
- » PZ Screwdriver PZ0, PZ1 (×2), PZ2 (×3), PZ3
- » 1/4" Ratcheting Bits Driver Set
 - » 1/4" Flat Bits 25 mm 1.0×5.5, 1.4×7.0
 - » Hex Socket Adaptor 1/4" Hex - 1/4" 25 mm
 - » 1/4" PH Bits 25 mm PH1, PH2
 - » 1/4" PZ Bits 25 mm PZ1, PZ2
- » 1/4" PH Bits 25 mm
 - » PH1 (×4), PH2 (×4), PH3 (×3)
- » 1/4" PH Bits 50 mm
 - » PH1, PH2 (×2), PH3
- » 1/4" PZ Bits 25 mm
 - » PZ1 (×4), PZ2 (×4), PZ3 (×3)
- » 1/4" PZ Bits 50 mm
 - » PZ1, PZ2 (×2), PZ3
- » 1/4" ROB Bits 25 mm
 - » 1, 2, 3
- » 1/4" TPX Bits 25 mm
 - » TPX10, TPX15, TPX20 (×2), TPX25 (×2), TPX27, TPX30, TPX40
- » 1/4" TX Bits 25 mm
 - » TX6, TX7, TX8, TX9, TX10, TX15, TX20 (×3), TX25 (×3), TX27, TX30, TX40
- » 1/4" TX Bits 50 mm
 - » TX8, TX10 (×2), TX15, TX20 (×2), TX25 (×2), TX27, TX30



TTEMD122N



3210 g

£519.90



SCREWDRIVER SET MIXED FOAM4X4 98 PIECES



- » 1/4" Flat Bits 25 mm
- » 0.6×3.5, 0.6×4.5, 0.8×4.0 (×2), 0.8×5.5, 1.0×5.5, 1.2×6.5, 1.6×8.0
- » 1/4" PH G Bits 25 mm PH2G
- » 1/4" Hex Bits 25 mm
 - » 2, 3, 4, 5, 6, 8
- » Hex Socket Adaptor 1/4" Hex - 1/4" 25 mm
- » 1/4" Bit Adaptor Hex Bit Coupler
- » TPX Screwdriver TPX10, TPX15, TPX20, TPX25, TPX30
- » TX Screwdriver TX8, TX9
- » Flat Mini Screwdriver 2, 2.4, 3
- » PH Mini Screwdriver PH00, PH0, PH1
- » TX Mini Screwdriver TX6, TX7, TX8, TX9, TX10, TX15
- » 1/4" Ratcheting Bits Driver Set
 - » 1/4" Flat Bits 25 mm 1.0×5.5, 1.4×7.0
 - » Hex Socket Adaptor 1/4" Hex - 1/4" 25 mm
 - » 1/4" PH Bits 25 mm PH1, PH2
 - » 1/4" PZ Bits 25 mm PZ1, PZ2
- » Flat Power Through Screwdriver
 - » 1.2×6.5, 1.2×8, 1.6×10
- » PH Power Through Screwdriver
 - » PH2, PH3
- » Flat Insulated Screwdriver
 - » 0.4×2.5, 0.8×4.0, 1.0×5.5
- » PH Insulated Screwdriver
 - » PH0, PH1, PH2
- » PZ Insulated Screwdriver PZ2
- » Magnetic Screwdriver Charger
- » 1/4" PH Bits 25 mm
 - » PH1 (×3), PH2 (×3), PH3 (×3)
- » 1/4" PZ Bits 25 mm PZ1 (×3), PZ2 (×3), PZ3 (×3)
- » 1/4" ROB Bits 25 mm 1, 2, 3
- » 1/4" TPX Bits 25 mm TPX10, TPX15, TPX20 (×2), TPX25 (×2), TPX27, TPX30, TPX40
- » 1/4" TX Bits 25 mm TX6, TX7, TX8, TX9, TX10, TX15, TX20 (×3), TX25 (×3), TX27, TX30, TX40



TTEMD98N



2330 g



£389.90



SCREWDRIVER SET MIXED FOAM4X4 114 PIECES



- » Ball Point Hex Key AF
 - » 5/64, 3/32, 1/8, 5/32, 3/16, 7/32, 1/4, 5/16, 3/8
- » Ball Point Hex Key Metric 1.5, 2, 2.5, 3, 4, 5, 6, 7, 8, 10
- » TX Key TX8, TX9, TX10, TX15, TX20, TX25, TX27, TX30, TX40
- » 1/4" Flat Bits 25 mm 0.6×3.5, 0.6×4.5, 0.8×4.0 (×2), 0.8×5.5, 1.0×5.5 (×3), 1.2×6.5, 1.4×7.0, 1.6×8.0
- » 1/4" PH G Bits 25 mm PH2G
- » 1/4" Hex Bits 25 mm 2, 3, 4, 5, 6, 8
- » Hex Socket Adaptor 1/4" Hex - 1/4" 25 mm
- » Hex Socket Adaptor 1/4" Hex - 1/4" 30 mm
- » 1/4" Bit Adaptor Hex Bit Coupler
- » Side Cutting Plier 160 mm
- » Heavy Duty Combination Plier 185 mm
- » Long Nose Plier 200 mm
- » Quick Set Water Pump Plier HRC60 250 mm
- » Flat Screwdriver 0.5×3.0, 1.0×5.5, 1.2×6.5
- » PH Screwdriver PH0, PH1, PH2
- » PZ Screwdriver PZ2 × 100 mm L Hex Shaft
- » 1/4" Ratcheting Bits Driver Set
 - » 1/4" Flat Bits 25 mm 1.0×5.5, 1.4×7.0
 - » Hex Socket Adaptor 1/4" Hex - 1/4" 25 mm
 - » 1/4" PH Bits 25 mm PH1, PH2
 - » 1/4" PZ Bits 25 mm PZ1, PZ2
- » 1/4" PH Bits 25 mm
 - » PH1 (×4), PH2 (×4), PH3 (×3)
- » 1/4" PZ Bits 25 mm
 - » PZ1 (×4), PZ2 (×4), PZ3 (×3)
- » 1/4" ROB Bits 25 mm
 - » 1, 2, 3
- » 1/4" TPX Bits 25 mm
 - » TPX10, TPX15, TPX20 (×2), TPX25 (×2), TPX27, TPX30, TPX40
- » 1/4" Bits Driver Extension 100 mm
- » 1/4" Bits Driver Extension 150 mm Flexible
- » 1/4" TX Bits 25 mm TX6, TX7, TX8, TX9, TX10, TX15, TX20 (×3), TX25 (×3), TX27, TX30, TX40

TTEM114  3090 g  £372.30



SCREWDRIVER & HEX/TX KEY SET 1 FOAM3 54 PIECES



- » Ball Point Hex Key Metric
 - » 1.5, 2, 2.5, 3, 4, 5, 6, 7, 10
- » TX Key
 - » TX8, TX9, TX10, TX15, TX20, TX25, TX27, TX30, TX40
- » 1/4" Flat Bits 25 mm
 - » 0.6×3.5, 1.0×5.5, 1.6×8.0
- » 1/4" Hex Bits 25 mm
 - » 2, 3, 4, 5, 6, 8
- » Hose Clip Driver 7 mm
- » Flat Screwdriver 1.2 × 6.5 × 100 mm L Hex Shaft
- » PH Screwdriver PH2 × 100 mm L
- » PZ Screwdriver PZ2 × 100 mm L
- » 1/4" Quick Chuck Bits Driver 217 mm
- » Flat Slim Insulated Screwdriver 0.8 × 4.0 mm
- » PH Slim Insulated Screwdriver PH1
- » PZ Slim Insulated Screwdriver PZ1
- » Measuring Tape Metric 5m
- » 1/4" PH Bits 25 mm
 - » PH1, PH2, PH3
- » 1/4" PZ Bits 25 mm
 - » PZ1, PZ2, PZ3
- » 1/4" ROB Bits 25 mm
 - » 1, 2, 3
- » 1/4" TPX Bits 25 mm
 - » TPX20, TPX25, TPX30
- » 1/4" TX Bits 25 mm
 - » TX10, TX15, TX20, TX25, TX30, TX40

TTFM54  1480 g  £212.90





SCREWDRIVER & HEX/TX KEY SET 2 FOAM3 54 PIECES



- » Ball Point Hex Key Metric
 - » 1.5, 2, 2.5, 3, 4, 5, 6, 7, 10
- » TX Key
 - » TX8, TX9, TX10, TX15, TX20, TX25, TX27, TX30, TX40
- » 1/4" Flat Bits 25 mm
 - » 0.6×3.5, 1.0×5.5, 1.6×8.0
- » 1/4" Hex Bits 25 mm
 - » 2, 3, 4, 5, 6, 8
- » Hose Clip Driver 7 mm
- » Flat Screwdriver 1.2 × 6.5 × 100 mm L Hex Shaft
- » PH Screwdriver PH2 × 100 mm L
- » PZ Screwdriver PZ2 × 100 mm L
- » 1/4" Quick Chuck Bits Driver 217 mm
- » Flat Slim Insulated Screwdriver 0.8 × 4.0 mm
- » PH Slim Insulated Screwdriver PH1
- » PZ Slim Insulated Screwdriver PZ1
- » Measuring Tape Metric/Inch 5m
- » 1/4" PH Bits 25 mm
 - » PH1, PH2, PH3
- » 1/4" PZ Bits 25 mm
 - » PZ1, PZ2, PZ3
- » 1/4" ROB Bits 25 mm
 - » 1, 2, 3
- » 1/4" TPX Bits 25 mm
 - » TPX20, TPX25, TPX30
- » 1/4" TX Bits 25 mm
 - » TX10, TX15, TX20, TX25, TX30, TX40

TEFMDI54	1590 g
	£223.90



POWER THROUGH SCREWDRIVER SET FOAMX4 5 PIECES



- » Flat Power Through Screwdriver
 - » 1.2×6.5, 1.2×8, 1.6×10
- » PH Power Through Screwdriver
 - » PH2, PH3

TEXMDTN	1325 g
	£91.90



BITS DRIVER SET FOAM1 78 PIECES



- » 1/4" Magnetic Bit Holder 50 mm
- » 1/4" Flat Bits 25 mm
 - » 0.6×3.5, 0.6×4.5, 0.8×4.0, 0.8×5.5, 1.0×5.5, 1.2×6.5, 1.6×8.0
- » 1/4" PH G Bits 25 mm PH2G
- » 1/4" Hex Bits 25 mm
 - » 2, 3, 4, 5, 6, 8
- » Hex Socket Adaptor 1/4" Hex - 1/4" 30 mm
- » 1/4" Socket 6 pt Metric
 - » 4, 5, 5.5, 6, 7, 8, 9, 10, 11, 12, 13
- » 1/4" Quick Chuck Bits Driver 147 mm
- » 1/4" PH Bits 25 mm
 - » PH1 (×3), PH2 (×6), PH3
- » 1/4" PZ Bits 25 mm
 - » PZ1 (×3), PZ2 (×6), PZ3
- » 1/4" Ratchet Head Hex/Square Drive
- » 1/4" ROB Bits 25 mm
 - » 1, 2, 3
- » 1/4" TPX Bits 25 mm
 - » TPX10, TPX15, TPX20 (×2), TPX25 (×2), TPX27, TPX30, TPX40
- » 1/4" TX Bits 25 mm
 - » TX6, TX7, TX8, TX9, TX10, TX15, TX20 (×3), TX25 (×3), TX27, TX30, TX40



TEAMDQ78



899 g

£113.90

IMPACT BIT SET FOAM1 50 PIECES



- » 1/4" PH G Impact Bits 30 mm PH2G
- » 1/4" PH G Impact Bits 50 mm PH2G
- » 1/4" Hex Impact Bits 30 mm
 - » 3, 4 (×2), 5, 6
- » 1/4" Hex Impact Bits 50 mm
 - » 3, 4, 5, 6
- » 1/4" Magnetic Impact Bit Holder 60 mm
- » 1/4" PH Impact Bits 30 mm
 - » PH1, PH2 (×2), PH3
- » 1/4" PH Impact Bits 50 mm
 - » PH1, PH2, PH3
- » 1/4" PZ Impact Bits 30 mm
 - » PZ1, PZ2 (×2), PZ3
- » 1/4" PZ Impact Bits 50 mm
 - » PZ1, PZ2, PZ3
- » 1/4" Quick Chuck Impact Bit Holder 60 mm
- » 1/4" ROB Impact Bits 30 mm
 - » 1, 2
- » 1/4" ROB Impact Bits 50 mm
 - » 1, 2, 3
- » 1/4" TX Impact Bits 30 mm
 - » TX10, TX15, TX20 (×2), TX25 (×2), TX27, TX30 (×2), TX40
- » 1/4" TX Impact Bits 50 mm
 - » TX10, TX15, TX20, TX25, TX27, TX30, TX40



TEABSS0



595 g

£104.90





T-HANDLE BALL POINT HEX KEY SET FOAM2 7 PIECES



» 2.5, 3, 4, 5, 6, 7, 8		
TEDHEX7	1029 g	£98.90



T-HANDLE BALL POINT TX KEY SET FOAM2 7 PIECES



» TX10, TX15, TX20, TX25, TX27, TX30, TX40		
TEDTX7	892 g	£96.50



BALL POINT HEX & TX KEY SET FOAM2 42 PIECES



» Folding Key Set Mixed 8 Pieces		
» Ball Point Hex Key AF		
» 5/64, 3/32, 1/8, 5/32, 3/16, 7/32, 1/4, 5/16, 3/8		
» Ball Point Hex Key Metric		
» 1.5, 2, 2.5, 3, 4, 5, 6, 7, 8, 10		
» TX Key		
» TX8, TX9, TX10, TX15, TX20, TX25, TX27, TX30, TX40		
» Mini TX Key		
» TX6, TX7, TX8, TX9, TX10, TX15		
TEDHT42	1668 g	£161.90

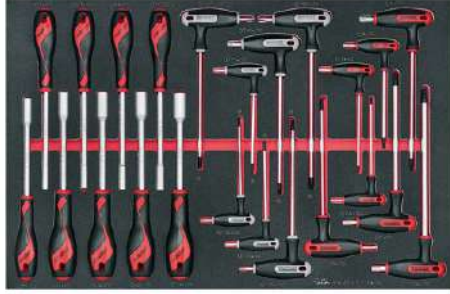

NUT DRIVER & HEX/TX T-HANDLE SET FOAM4X4 23 PIECES



- » T Handle Ball Point Hex Key Metric 2.5, 3, 4, 5, 6, 7, 8
- » T Handle TX Key TX10, TX15, TX20, TX25, TX27, TX30, TX40
- » Nut Driver 5, 5.5, 6, 7, 8, 10, 11, 12, 13



TTEX23N



2271 g

£362.90



PLIER SET VINYL GRIP Q FOAM2 5 PIECES



- » Side Cutting Plier 135 mm
- » Heavy Duty Side Cutting Plier 200 mm
- » Heavy Duty Combination Plier 200 mm
- » Long Nose Plier 200 mm
- » Quick Set Water Pump Plier HRC60 250 mm



TED441Q



1549 g

£208.90



PLIER SET TPR GRIP Q FOAM2 5 PIECES



- » Side Cutting Plier TPR Grip 140 mm
- » Heavy Duty Side Cutting Plier TPR Grip 200 mm
- » Heavy Duty Combination Plier TPR Grip 200 mm
- » Long Nose Plier TPR Grip 205 mm
- » Quick Set Water Pump Plier TPR Grip HRC60 250 mm



TED441-TQ



1666 g

£224.90

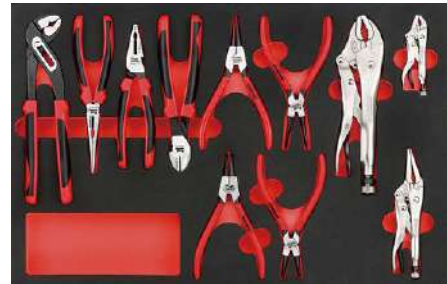

PLIER SET FOAM4X4 11 PIECES



- » Curved Jaw Power Grip Plier 235 mm
- » Curved Jaw Power Grip Plier 105 mm
- » Long Nose Power Grip Plier 170 mm
- » Heavy Duty Side Cutting Plier TPR Grip 200 mm
- » Heavy Duty Combination Plier TPR Grip 190 mm
- » Long Nose Plier TPR Grip 205 mm
- » Circlip Plier Inner Straight 185 mm
- » Circlip Plier Inner Bent 170 mm
- » Circlip Plier Outer Straight 180 mm
- » Circlip Plier Outer Bent 165 mm
- » Water Pump Plier TPR Grip 250 mm



TTEMB11



2620 g

£353.90



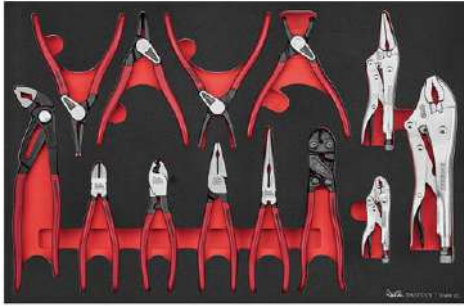

PLIER SET Q FOAM4X4 13 PIECES



- » Curved Jaw Power Grip Plier 235 mm
- » Curved Jaw Power Grip Plier 105 mm
- » Long Nose Power Grip Plier 170 mm
- » Mini Bolt Cutter 200 mm
- » Side Cutting Plier 160 mm
- » Cable Cutter 160 mm
- » Heavy Duty Combination Plier 185 mm
- » Long Nose Plier 200 mm
- » Quick Set Water Pump Plier HRC60 250 mm
- » Circlip Plier Inner Straight PRO 175 mm
- » Circlip Plier Inner Bent PRO 175 mm
- » Circlip Plier Outer Straight PRO 175 mm
- » Circlip Plier Outer Bent PRO 165 mm



TTEMB13Q

2935 g

£461.90

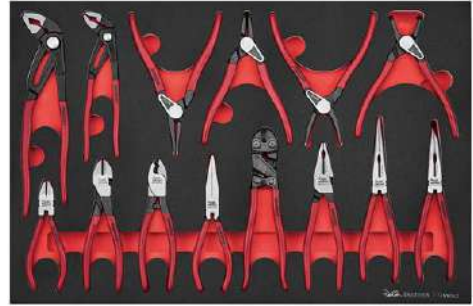

PLIER SET VINYL GRIP Q FOAM4X4 14 PIECES



- » Mini Bolt Cutter 200 mm
- » Side Cutting Plier 135 mm
- » Heavy Duty Side Cutting Plier 160 mm
- » Cable Cutter 160 mm
- » Heavy Duty Combination Plier 185 mm
- » Long Nose Plier 200 mm
- » Bent Long Nose Plier 200 mm
- » Flat Nose Plier 165 mm
- » Quick Set Water Pump Plier HRC60 250 mm
- » Quick Set Water Pump Plier HRC60 185 mm
- » Circlip Plier Inner Straight PRO 175 mm
- » Circlip Plier Inner Bent PRO 175 mm
- » Circlip Plier Outer Straight PRO 175 mm
- » Circlip Plier Outer Bent PRO 165 mm



TTEMB14Q

2740 g

£509.90

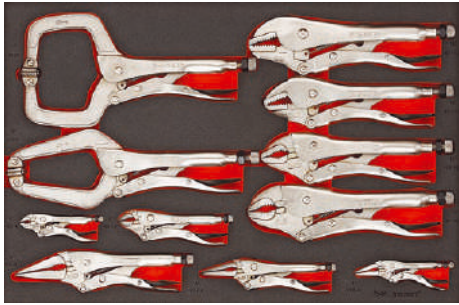

POWER GRIP PLIER SET FOAM4X4 11 PIECES

11 PCS FOAM SERIES SIZE 4x4 4X4



- » Curved Jaw Power Grip Plier 235 mm
- » Flat Jaw Power Grip Plier 250 mm
- » Curved Jaw Power Grip Plier 300 mm
- » Flat Jaw Power Grip Plier 300 mm
- » Curved Jaw Power Grip Plier 105 mm
- » Curved Jaw Power Grip Plier 125 mm
- » Long Nose Power Grip Plier 125 mm
- » Long Nose Power Grip Plier 170 mm
- » Long Nose Power Grip Plier 230 mm
- » Swivel C Clamp Power Grip Plier 280 mm
- » Swivel Clamping Power Grip Plier 300 mm



TTEVG11 4920 g £383.90



POWER GRIP PLIER SET FOAMX2 3 PIECES

3 PCS FOAM SERIES SIZE x2 P2



- » Curved Jaw Power Grip Plier 105 mm
- » Long Nose Power Grip Plier 125 mm
- » Long Nose Power Grip Plier 170 mm



TEZVG03 541 g £71.90



INSULATED INTERCHANGEABLE BLADE SET FOAM10 PIECES

10 PCS FOAM SERIES SIZE 1 D1E 5264 DIN 5264 DIN 8764 1000V IEC 60900 - + *



- » Insulated Handle for Interchangeable Blades L
- » Insulated Handle for Interchangeable Blades S
- » Interchangeable Blade Insulated Screwdriver 3, 4, 5.5, 6.5, PH1, PH2, PZ1, PZ2



TEAMDV10 481 g £71.20



INSULATED SCREWDRIVER SET FLAT FOAM1 4 PIECES

4 PCS FOAM SERIES SIZE 1 D1E 5264 1000V IEC 60900 -



- » Flat Slim Insulated Screwdriver 0.8x4.0, 1.0x5.5
- » Flat Insulated Screwdriver 0.4x2.5, 0.5x3.0



TEAMDV04N 414 g £48.70





INSULATED SCREWDRIVER SET PH/PZ FOAM1 4 PIECES



- » PH Slim Insulated Screwdriver
PH1, PH2
- » PZ Slim Insulated Screwdriver
PZ1, PZ2

TEAMDV04N1	522 g
	£55.20



INSULATED SCREWDRIVER SET MIXED FOAM2 9 PIECES



- » Flat Insulated Screwdriver
0.4×2.5, 0.6×3.5, 0.8×4.0, 1.0×5.5
- » PH Insulated Screwdriver
PH0, PH1, PH2
- » PZ Insulated Screwdriver PZ2
- » Voltage Tester

TEDV909N	934 g
	£108.90

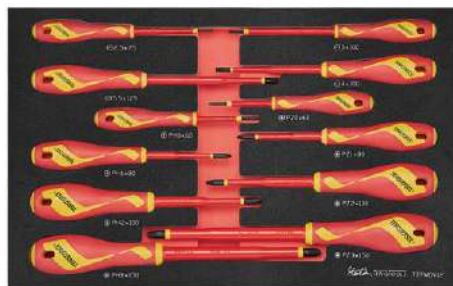

INSULATED SCREWDRIVER SET FOAM3 12 PIECES



- » Flat Slim Insulated Screwdriver
0.8×4.0, 1.0×5.5
- » PH Slim Insulated Screwdriver
PH1, PH2
- » PZ Slim Insulated Screwdriver
PZ1, PZ2
- » Flat Insulated Screwdriver
0.4×2.5, 0.5×3.0
- » PH Insulated Screwdriver
PH0, PH3
- » PZ Insulated Screwdriver
PZ0, PZ3

TEFMDV12	969 g
	£149.90



INSULATED SCREWDRIVER & KNIFE SET FOAM3 15 PIECES



- » Flat Insulated Screwdriver
0.4×2.5, 0.5×3.0, 0.8×4.0, 1.0×5.5
- » PH Insulated Screwdriver
PH0, PH1, PH2
- » PZ Insulated Screwdriver
PZ0, PZ1, PZ2
- » Insulated Knife
- » Replacement Blades For Insulated Knife



TEFMDV15

917 g

£154.90



INSULATED PLIER & SCREWDRIVER SET FOAM3 11 PIECES



- » Insulated Side Cutting Plier 160 mm
- » Insulated Combination Plier 185 mm
- » Insulated Long Nose Plier 215 mm
- » Insulated Wire Stripping Plier
- » Flat Slim Insulated Screwdriver 0.8 × 4.0 mm
- » PH Slim Insulated Screwdriver
PH1, PH2
- » PZ Slim Insulated Screwdriver
PZ1, PZ2
- » Flat Insulated Screwdriver 0.4 × 2.5 mm
- » Voltage Tester



TEFXV11

1268 g

£256.90





INSULATED SPANNER & SCREWDRIVER SET FOAM3 17 PIECES

17 PCS
FOAM SERIES
SIZE 3
mm
D'E
DIN
1000V
—
+
✦

- » Flat Insulated Screwdriver
0.8x4.0, 1.0x5.5
- » PH Insulated Screwdriver
PH1, PH2
- » PZ Insulated Screwdriver PZ2
- » Insulated Knife
- » Replacement Blades For Insulated Knife
- » Insulated Spanner
8, 10, 12, 13, 14, 17, 19

TEFXV17 1248 g £302.90



INSULATED PLIER SET FOAM2 4 PIECES

4 PCS
FOAM SERIES
SIZE 2
D'E
DIN 5745
DIN 5746
DIN 5749
1000V

- » Insulated Side Cutting Plier 160 mm
- » Insulated Combination Plier 185 mm
- » Insulated Long Nose Plier 215 mm
- » Insulated Wire Stripping Plier

TEDV440 1178 g £174.90



INSULATED PLIER & KNIFE SET FOAM2 8 PIECES

8 PCS
FOAM SERIES
SIZE 2
D'E
1000V

- » Insulated Cable Cutter 210 mm
- » Insulated Long Nose Plier Bent 210 mm
- » Insulated Water Pump Plier 260 mm
- » Insulated Knife
- » Replacement Blades For Insulated Knife

TEDVMB08 1480 g £205.90



INSULATED PLIER SET FOAM3 7 PIECES

7 PCS
FOAM SERIES
SIZE 3
D'E
1000V

- » Insulated Side Cutting Plier 160 mm
- » Insulated Cable Cutter 210 mm
- » Insulated Combination Plier 185 mm
- » Insulated Long Nose Plier 215 mm
- » Insulated Long Nose Plier Bent 210 mm
- » Insulated Water Pump Plier 260 mm
- » Insulated Wire Stripping Plier

TEFMBV07 1747 g £304.90



3/8" INSULATED SOCKET SET FOAM2 18 PIECES



- » 3/8" Insulated Ratchet 72 Teeth
- » 3/8" Insulated Extension Bar 75 mm
- » 3/8" Insulated Extension Bar 150 mm
- » 3/8" Insulated Socket
- » 6, 7, 8, 9, 10, 11, 12, 13, 14, 15, 16, 17, 18, 19, 20



TEDV3818

1578 g

£408.90



INSULATED TORQUE SCREWDRIVER SET FOAM3 27 PIECES



- » Insulated Torque Screwdriver 1-5Nm
- » Interchangeable Blade Insulated Screwdriver
- » 3, 4, 5.5, 6.5, PH1, PH2, PZ1, PZ2
- » 3/8" Insulated Ratchet 72 Teeth
- » 3/8" Insulated Extension Bar 75 mm
- » 3/8" Insulated Extension Bar 150 mm
- » 3/8" Insulated Socket
- » 6, 7, 8, 9, 10, 11, 12, 13, 14, 15, 16, 17, 18, 19, 20



TEFXV27

1651 g

£643.90



INSULATED SOCKET & SCREWDRIVER SET FOAM3 28 PIECES



- » Insulated Handle for Interchangeable Blades L
- » Insulated Handle for Interchangeable Blades S
- » Interchangeable Blade Insulated Screwdriver
- » 3, 4, 5.5, 6.5, PH1, PH2, PZ1, PZ2
- » 3/8" Insulated Ratchet 72 Teeth
- » 3/8" Insulated Extension Bar 75 mm
- » 3/8" Insulated Extension Bar 150 mm
- » 3/8" Insulated Socket
- » 6, 7, 8, 9, 10, 11, 12, 13, 14, 15, 16, 17, 18, 19, 20



TEFXV28

1523 g

£503.90





INSULATED SOCKET & SPANNER SET FOAM3 19 PIECES



- » Insulated Side Cutting Plier 160 mm
- » Insulated Combination Plier 185 mm
- » Insulated Long Nose Plier Bent 210 mm
- » Insulated Wire Stripping Plier
- » 3/8" Insulated Ratchet 72 Teeth
- » 3/8" Insulated Extension Bar 75 mm
- » 3/8" Insulated Extension Bar 150 mm
- » 3/8" Insulated Socket
- » 8, 9, 10, 11, 12, 13, 14, 15, 17, 18, 19, 20



TEFSKV19 1896 g £513.90



INSULATED SPANNER SET FOAM2 12 PIECES



- » 8, 9, 10, 11, 12, 13, 14, 15, 16, 17, 18, 19



TEDEVSP12 1510 g £344.90



INSULATED SPANNER SET FOAM3 17 PIECES



- » 7, 8, 9, 10, 11, 12, 13, 14, 15, 16, 17, 18, 19, 20, 21, 22, 24



TEFSPV17 2215 g £545.90



CUTTING TOOL SET FOAM2 6 PIECES



- » Compact tin snip straight cut Cr-Mo 190 mm
- » Compact tin snip straight/right cut Cr-Mo 182 mm
- » Compact tin snip straight/left cut Cr-Mo 182 mm
- » Scissors 5-1/2"
- » Deburring Tool Pocket Clip
- » Scriber With Carbide Tip



TEDCT06 1185 g £196.90



MEASURING TOOL SET FOAM2 3 PIECES

3 PCS FOAM SERIES SIZE 2 AF mm

- » Digital Caliper 0-150 mm
- » Dial Gauge with Magnetic Stand 0-10 mm
- » Micrometer 0 - 25 mm



TEDIMM 1901 g £255.90

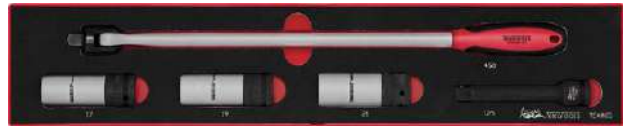

WHEEL TOOL SET FOAMX4 5 PIECES

5 PCS FOAM SERIES SIZE x4 1/2"

- » 1/2" Breaker Bar 450 mm DIN3122
- » 1/2" Impact Extension Bar DIN (F) ANSI (M) 125 mm
- » 1/2" Impact Socket Wheel Nut
- » 17, 19, 21



TEXW05 2205 g £155.90



3/8" T BAR SPARK PLUG SOCKET SET FOAMX4 5 PIECES

5 PCS FOAM SERIES SIZE x4 mm 3/8"

- » T Bar Handle Grip
- » T Bar for T Bar Sockets
- » 3/8" T-Bar Spark Plug Socket
- » 14, 16, 21



TEXTB05 1713 g £153.90



PRY BAR SET ROLL/HEEL FOAMX4 4 PIECES

4 PCS FOAM SERIES SIZE x4

- » Tyre Lever 500 mm
- » Pry Bar Roll Heel Type 300 mm
- » Pry Bar Roll Heel Type 400 mm
- » Pry Bar Roll Heel Type 500 mm



TEXPB4 2687 g £169.90





PUNCH & CHISEL SET FOAM2 14 PIECES

14 PCS FOAM SERIES SIZE 2

- » Flat Cold Chisel
 - » 18, 25 (x2), 26
- » Centre Punch
 - » 4, 5, 8
- » Parallel Pin Punch
 - » 3, 4, 5, 6, 7, 8
- » Automatic Centre Punch

TEDP014 2624 g £223.90



EXTRACTOR AND NUT SPLITTER SET FOAM2 6 PIECES

6 PCS FOAM SERIES SIZE x2 1/2"

- » Nut Splitter Set 2 Pieces
- » 1/2" Stud Extractor Socket
 - » 6, 8, 10, 12

TEZSN06 1340 g £138.90



RIVET GUN SET FOAM1 81 PIECES

81 PCS FOAM SERIES SIZE 1

- » Aluminium Rivets 2.4 mm x 20
- » Aluminium Rivets 3.2 mm x 20
- » Aluminium Rivets 4.0 mm x 20
- » Aluminium Rivets 4.8 mm x 20
- » Hand Rivet Gun Aluminium Alloy 2.4/3.2/4.0/4.8 mm

TEAHR81 899 g £123.90



CLIP & PANEL REMOVER SET FOAM1 4 PIECES

4 PCS FOAM SERIES SIZE 1

- » Panel clip removal tool U-shape
- » Panel clip removal tool U-shape large
- » Trim clip removal tool V-shape
- » Trim clip removal tool V-shape large

TEASR04A 643 g £56.60

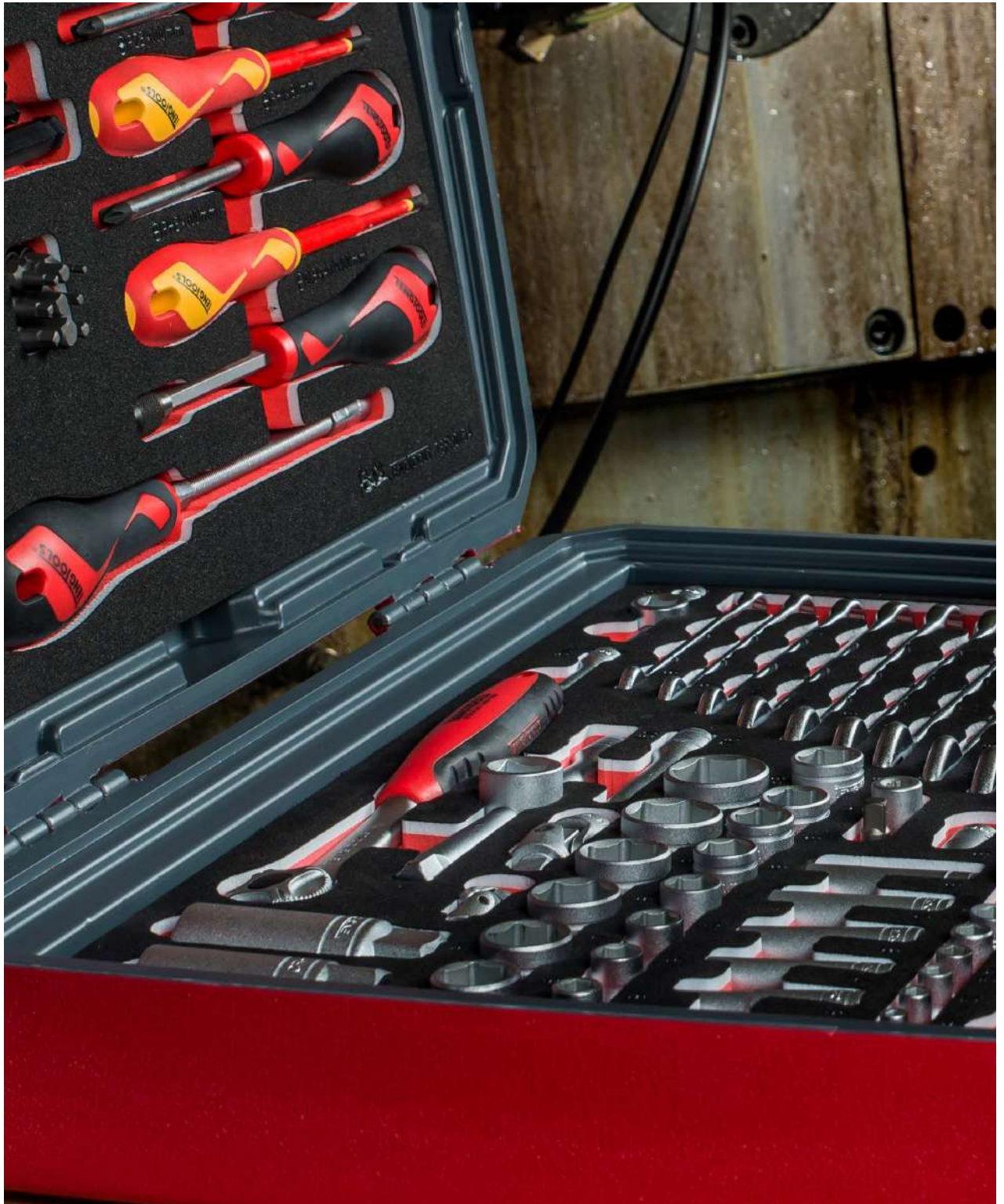

OTHER TOOL SETS

A VARIETY OF TOOL SETS INCLUDING PORTABLE SOLUTIONS AND WALL RACKS

A portable tool kit can be a convenient, organised, space-saving, versatile, and cost-effective option for people who need to take their tools with them or have limited storage space





OTHER TOOL KITS



1/2" SOCKET & TOOL SET HDV 105 PIECES



- » 1/2" Ratchet FRP 45 Teeth
- » 1/2" Breaker Bar 450 mm DIN3122
- » 1/4" Mini Bits Ratchet
- » Ball Point Hex Key Set 9 Pieces
 - » Ball Point Hex Key Metric 1.5, 2, 2.5, 3, 4, 5, 6, 8, 10
- » Ball point hex key, metric, 7 mm
- » Adjustable Wrench 150 mm
- » Adjustable Wrench 300 mm
- » Telescopic Magnetic Pick Up Tool And Pen
- » Combination Spanner Metric
 - » 8, 10, 11, 12, 13, 14, 15, 16, 17, 18, 19, 21, 22, 24, 25, 26, 27, 30, 32
- » 1/4" Magnetic Bit Holder 50 mm
- » 1/4" Flat Bits 25 mm
 - » 0.6×3.5, 1.0×5.5, 1.6×8.0
- » 1/4" Hex Bits 25 mm
 - » 2, 3, 4, 5, 6, 8
- » Ball Pein Hammer 24oz
- » 1/2" Extension Bar 125 mm
- » 1/2" Socket 6 pt Metric
 - » 8, 10, 12, 13, 14, 15, 16, 17, 18, 19, 21, 22, 24, 25, 26, 27, 30, 32
- » 1/2" Hex Bit Socket Metric
 - » 5, 6, 7, 8, 10, 12, 14, 17, 19
- » Side Cutting Plier 160 mm
- » Heavy Duty Combination Plier 185 mm
- » Quick Set Water Pump Plier HRC60 250 mm
- » Flat Screwdriver 0.5 × 2.5 × 75 mm S
- » Hook Tool 125°
- » 1/4" Ratcheting Bits Driver Set
 - » 1/4" Flat Bits 25 mm 1.0×5.5, 1.4×7.0
 - » Hex Socket Adaptor 1/4" Hex - 1/4" 25 mm
 - » 1/4" PH Bits 25 mm PH1, PH2
 - » 1/4" PZ Bits 25 mm PZ1, PZ2
- » 1/4" PH Bits 25 mm PH1, PH2, PH3
- » 1/4" PZ Bits 25 mm PZ1, PZ2, PZ3
- » 1/4" ROB Bits 25 mm 1, 2, 3
- » 1/4" TPX Bits 25 mm TPX20, TPX25, TPX30
- » 1/4" TX Bits 25 mm TX10, TX15, TX20, TX25, TX30, TX40



THDV105



13010 g

£892.00



1/2" SOCKET & TOOL SET HDV E 105 PIECES

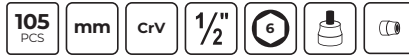

- » 1/2" Ratchet FRP 45 Teeth
- » 1/2" Breaker Bar 450 mm DIN3122
- » 1/4" Mini Bits Ratchet
- » Ball Point Hex Key Set 9 Pieces
 - » Ball Point Hex Key Metric 1.5, 2, 2.5, 3, 4, 5, 6, 8, 10
- » Ball point hex key, metric, 7 mm
- » Adjustable Wrench 150 mm
- » Adjustable Wrench 300 mm
- » Telescopic Magnetic Pick Up Tool And Pen
- » Combination Spanner Metric
 - » 8, 10, 11, 12, 13, 14, 15, 16, 17, 18, 19, 21, 22, 24, 25, 26, 27, 30, 32
- » 1/4" Magnetic Bit Holder 50 mm
- » 1/4" Flat Bits 25 mm
 - » 0.6×3.5, 1.0×5.5, 1.6×8.0
- » 1/4" Hex Bits 25 mm
 - » 2, 3, 4, 5, 6, 8
- » Engineers Hammer 800g
- » 1/2" Extension Bar 125 mm
- » 1/2" Socket 6 pt Metric
 - » 8, 10, 12, 13, 14, 15, 16, 17, 18, 19, 21, 22, 24, 25, 26, 27, 30, 32
- » 1/2" Hex Bit Socket Metric
 - » 5, 6, 7, 8, 10, 12, 14, 17, 19
- » Side Cutting Plier 160 mm
- » Heavy Duty Combination Plier 185 mm
- » Quick Set Water Pump Plier HRC60 250 mm
- » Flat Screwdriver 0.5 × 2.5 × 75 mm S
- » Hook Tool 125°
- » 1/4" Ratcheting Bits Driver Set
 - » 1/4" Flat Bits 25 mm 1.0×5.5, 1.4×7.0
 - » Hex Socket Adaptor 1/4" Hex - 1/4" 25 mm
 - » 1/4" PH Bits 25 mm PH1, PH2
 - » 1/4" PZ Bits 25 mm PZ1, PZ2
- » 1/4" PH Bits 25 mm PH1, PH2, PH3
- » 1/4" PZ Bits 25 mm PZ1, PZ2, PZ3
- » 1/4" ROB Bits 25 mm 1, 2, 3
- » 1/4" TPX Bits 25 mm TPX20, TPX25, TPX30
- » 1/4" TX Bits 25 mm TX10, TX15, TX20, TX25, TX30, TX40



THDV105E



13091 g

£892.00



BARN STYLE TOOL BOX TOOL KIT 187 PIECES

187
PCS



- » 1/2" Ratchet FRP 45 Teeth
- » 1/4" Ratchet FRP 45 Teeth
- » 3/8" Ratchet FRP 45 Teeth
- » Hex Key Metric
- » 1.5, 2, 2.5
- » Spanner Ring
- » Combination Spanner Metric 8, 10, 11, 12, 13, 14, 15, 17, 19
- » Socket Clips 10 × 1/2" (x3)
- » Socket Clips 10 × 1/4" (x3)
- » Socket Clips 10 × 3/8" (x3)
- » 1/4" Flat Bits 25 mm 0.8×4.0, 0.8×5.5, 1.4×7.0
- » 1/4" Hex Bits 25 mm 3, 4, 5, 6, 7, 8, 10
- » 1/2" Extension Bar 63.5 mm
- » 1/2" Extension Bar 150 mm
- » 1/2" Universal Joint
- » Reducing Adaptor 1/2"F - 3/8"M
- » 1/2" Socket 12 pt Metric
- » 10, 11, 12, 13, 14, 15, 16, 17, 18, 19, 21, 22, 24, 27, 30, 32
- » 1/4" Extension Bar 50 mm
- » 1/4" Extension Bar 100 mm
- » 1/4" Universal Joint
- » 1/4" Bit Adaptor Hex Bit Coupler
- » 1/4" Socket 6 pt Metric 4, 5, 5.5, 6, 7, 8, 10, 11, 12, 13
- » 1/4" Deep Socket 6 pt Metric 6, 7, 8, 10, 12, 13
- » 3/8" Extension Bar 150 mm
- » 3/8" Universal Joint
- » 3/8" Drive Adaptor 3/8"F:1/4"M with 1/4" hole
- » Step Up Adaptor 3/8"F - 1/2"M
- » 3/8" Bit Adaptor Hex bit coupler 1/4" Hex
- » 3/8" Socket 6 pt Metric
- » 8, 9, 10, 11, 12, 13, 14, 15, 16, 17, 18, 19, 21, 22
- » 1/4" PH Bits 25 mm
- » PH1, PH2
- » 1/4" PZ Bits 25 mm
- » PZ1, PZ2
- » Barn Style Tool Box
- » 1/4" TX Bits 25 mm
- » TX8, TX10, TX15, TX20, TX25, TX27, TX30, TX40



TC187

10490 g

£514.90



TOOL PANEL KIT 16 PIECES RED

16
PCS



- » Adjustable Wrench 600 mm
- » Bolt Cutter 600 mm
- » Groove Joint Water Pump Plier 400 mm
- » Aluminium Pipe Wrench 450 mm
- » Magnetic Tool Rail
- » Tool Hooks 7 × 90° & 3 × 45°
- » Tool Hooks 10 × 45°
- » Tool Hooks 10 × 90°
- » Side Panel with Stand



TKP26R16

14730 g

£729.00



OTHER TOOL KITS



COMBINATION SPANNER SET 8-19 MM WALL RACK 12 PIECES



- » Combination Spanner Metric
- » 8, 9, 10, 11, 12, 13, 14, 15, 16, 17, 18, 19
- » Replacement Wall Rack WRSP12



WRSP12

1375 g

£107.90



HAND FILE SET WALL RACK 5 PIECES

5
PCS



- » Hand File 250 mm Flat
- » Hand File 250 mm Flat Tapered
- » Hand File 250 mm Half round
- » Hand File 250 mm Round
- » Hand File 250 mm Triangular
- » Replacement Wall Rack WRFL05



WRFL05

1604 g

£80.50



DOUBLE FLEX WRENCH SET WALL RACK 6 PIECES



- » Double Flex Wrench Metric
- » 8×9, 10×11, 12×13, 14×15, 16×17, 18×19
- » Replacement Wall Rack WRDF06



WRDF06

1554 g

£174.50



POWER THROUGH SCREWDRIVER SET WALL RACK 5 PIECES



- » Flat Power Through Screwdriver
1.2×6.5, 1.2×8, 1.6×10
- » PH Power Through Screwdriver
PH2, PH3
- » Replacement Wall Rack WRMDT05



WRMDT05N

1035 g

£82.20



T-HANDLE TX/TPX KEY SET WALL RACK 7 PIECES



- » T Handle TX Key
TX10, TX15, TX20, TX25, TX27, TX30, TX40
- » Replacement Wall Rack WRTX07



WRTX07

714 g

£74.50





-
-
-
-
-
-
-
-
-
-
-
-
-
-
-
-
-
-

Scan the QR code
to contact us or
request a call back





-
-
-
-
-
-
-
-
-
-
-
-
-
-
-
-
-

PRO35™

MADE FOR PROFESSIONALS

Introducing the next generation in tool storage, specifically designed to cater to the demands of professionals in automotive, maintenance, engineering, and motorsport. Crafted with a robust 3-piece heavy gauge steel cabinet frame and fortified with our advanced 5-step phosphate-free rust protection, they are built to last even in the toughest work environments.



**3-PIECE HEAVY GAUGE
STEEL CABINET FRAME**



**5-STEP PHOSPHATE-FREE
RUST PROTECTION**



**3-DIGIT
COMBINATION LOCK**



**UP TO 40KG DRAWER
LOADING CAPACITY**



**ALL DRAWERS COMPATIBLE
WITH OUR MODULAR TOOL
CONTROL SYSTEM**

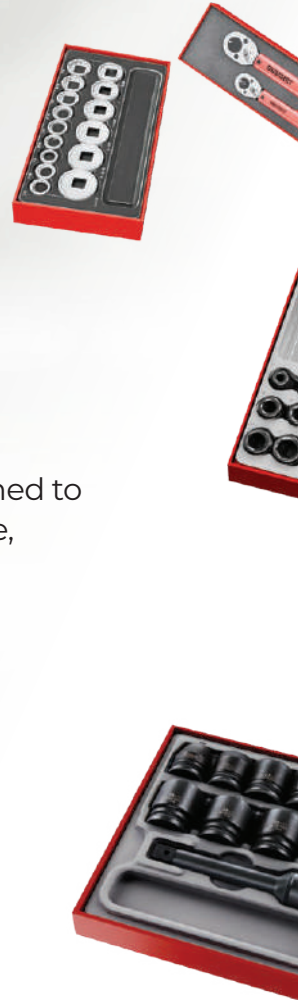



Read more about product care and the TengTools Lifetime guarantee here:



IMPROVED FEATURES



3-DIGIT COMBINATION LOCK

Flexible Security Options - Secure your tools with our multiple lock options. Switch between combination and key locks depending on your preference, keeping your tools safe and accessible.

FLAT ALUMINIUM DRAWER FRONT HANDLES

Aluminum handles with space for labelling ensure you stay organised. Label your drawers to reflect the contents, tailored by you.



NEW REINFORCED DRAWER DESIGN

Our drawers are engineered to fit TengTools Tool Control Modules seamlessly. Reinforced and capable of holding up to 40kg, they're built for heavy-duty use.

The drawers are tested pulling them out and pushing them in more than 35,000 times with maximum drawer load.

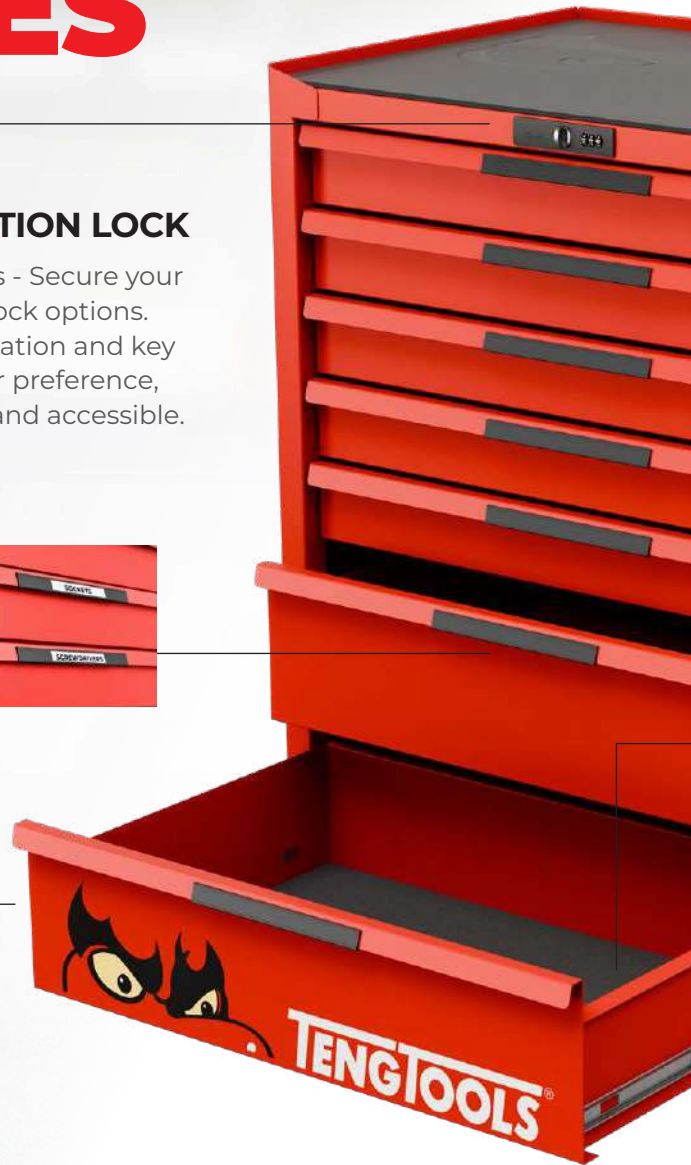

FOAM WORKTOP MAT AS STANDARD.

Upgrade to hard-wearing laminated wood or sleek stainless-steel worktops. Available in multiple sizes for a perfect fit.



COMFORT GRIP HANDLE

Ergonomically designed for ease of movement. When used with a side shelf it creates extra space for storing longer items conveniently at your side.



EXTRA TOOL PROTECTION

FOAM mats supplied in each drawer to protect loose tools while being stored.

FULL EXTENSION BALL BEARING SLIDES

Each drawer is fully extendable with ball bearing slides ensuring a smooth and reliable opening, and closing action every time.

HEAVY-DUTY CASTORS

Navigate your workspace with ease using our robust castors. Supplied with two fixed and two swivel, with brakes for stability when you need it.

RECESSED SIDE HANDLES (TOOL CHESTS)

Fold-down side handles with 150kg capacity each.



PRO35™

BOOST YOUR PERFORMANCE

Elevate your workspace with TengTools PRO35™ Series Tool Cabinets. These cabinets boast a host of enhanced features crafted to boost your performance. From reinforced drawer designs capable of holding up to 40kg to precision-engineered compatibility with our Tool Control System, every detail has been refined to ensure seamless functionality and unparalleled convenience. Say goodbye to cluttered workspaces and hello to streamlined productivity.





PRO35™







11" PRO35™ TOOL CHEST 2 DRAWERS RED

2 Drawer

5-Step Phosphate-Free Rust Protection

Heavy Gauge Steel

	 (mm)	 (mm)	 (mm)		
TST11R2	310	210	190	2950 g	£165.90





PRO35™



PRO35™



26" PRO35™ TOOL CHEST 4 DRAWERS RED

- 4 Drawer
- 26" Wide Box
- 3-Step Ball Bearing Slides
- Heavy Gauge Steel
- 5-Step Phosphate-Free Rust Protection
- Up To 30kg Drawer Loading Capacity
- Combination Lock As Standard

	(mm)	(mm)	(mm)	(Kg)
	660	305	380	
1	569	275	50	30
2	569	275	50	30
3	569	275	50	30
4	569	275	75	30



TST26R4

£577.90

26" PRO35™ TOOL CHEST 4 DRAWERS BLACK

- 4 Drawer
- 26" Wide Box
- 3-Step Ball Bearing Slides
- Heavy Gauge Steel
- 5-Step Phosphate-Free Rust Protection
- Up To 30kg Drawer Loading Capacity
- Combination Lock As Standard

	(mm)	(mm)	(mm)	(Kg)
	660	305	380	
1	569	275	50	30
2	569	275	50	30
3	569	275	50	30
4	569	275	75	30



TST26B4

£577.90



PRO35™



26" PRO35™ TOOL CHEST 4 DRAWERS BLACK WITH CUSTOM STICKER

- 4 Drawer**
- 26" Wide Box**
- 3-Step Ball Bearing Slides**
- Heavy Gauge Steel**
- 5-Step Phosphate-Free Rust Protection**
- Up To 30kg Drawer Loading Capacity**
- Combination Lock As Standard**

	(mm)	(mm)	(mm)	(Kg)
	660	305	380	
1	569	275	50	30
2	569	275	50	30
3	569	275	50	30
4	569	275	75	30



TST26B4P

£577.90



PRO35™



26" PRO35™ DEEP TOOL CHEST 5 DRAWERS RED

- 5 Drawer**
- 26" Wide Box**
- 3-Step Ball Bearing Slides**
- Heavy Gauge Steel**
- 5-Step Phosphate-Free Rust Protection**
- Up To 30kg Drawer Loading Capacity**
- Combination Lock As Standard**

	(mm)	(mm)	(mm)	(Kg)
	660	455	483	
1	575	380	50	30
2	575	380	50	30
3	575	380	75	30
4	575	380	75	30
5	575	380	75	30



TST26R5F

£961.90





PRO35™



26" PRO35™ TOOL CHEST 3 DRAWERS RED

- 3 Drawer**
- 26" Wide Box**
- 3-Step Ball Bearing Slides**
- Heavy Gauge Steel**
- 5-Step Phosphate-Free Rust Protection**
- Up To 30kg Drawer Loading Capacity**
- Combination Lock As Standard**

	 (mm)	 (mm)	 (mm)	 (Kg)
	660	305	250	
1	569	275	50	30
2	569	275	50	30
3	569	275	75	30



TSM26R3

£389.90



PRO35™



26" PRO35™ TOOL CHEST 3 DRAWERS BLACK

- 3 Drawer**
- 26" Wide Box**
- 3-Step Ball Bearing Slides**
- Heavy Gauge Steel**
- 5-Step Phosphate-Free Rust Protection**
- Up To 30kg Drawer Loading Capacity**
- Combination Lock As Standard**

	 (mm)	 (mm)	 (mm)	 (Kg)
	660	305	250	
1	569	275	50	30
2	569	275	50	30
3	569	275	75	30



TSM26B3

£389.90



PRO35™



37" PRO35™ TOOL CHEST 5 DRAWERS RED

- 5 Drawer
- 3-Step Ball Bearing Slides
- 5-Step Phosphate-Free Rust Protection
- Combination Lock As Standard
- 37" Wide Box
- Heavy Gauge Steel
- Up To 25kg Drawer Loading Capacity

	(mm)	(mm)	(mm)	(Kg)
	945	455	483	
1	860	380	50	25
2	860	380	50	25
3	860	380	75	25
4	860	380	75	25
5	860	380	75	25



TST37R5F

£1,589.00



PRO35™



53" PRO35™ TOOL CHEST 10 DRAWERS RED

- 10 Drawer
- 3-Step Ball Bearing Slides
- 5-Step Phosphate-Free Rust Protection
- Combination Lock As Standard
- 53" Wide Box
- Heavy Gauge Steel
- Up To 40kg Drawer Loading Capacity

	(mm)	(mm)	(mm)	(Kg)
	1337	455	560	
1	575	380	75	40
2	575	380	75	40
3	575	380	75	40
4	575	380	75	40
5	575	380	75	40
6	575	380	75	40
7	575	380	75	40
8	575	380	75	40
9	575	380	75	40
10	575	380	75	40



TST53R10F

£2,549.00





PRO35™



PRO35™



26" PRO35™ LOW ROLLER CABINET 4 DRAWERS RED

- 4 Drawer
- 26" Wide Box
- 3-Piece Cabinet Frame
- Heavy Gauge Steel
- 5-Step Phosphate-Free Rust Protection
- Up To 40kg Drawer Loading Capacity
- 3-Step Ball Bearing Slides
- Comfort Grip Handle
- Combination Lock As Standard
- 4" x 1-1/4" Castor Wheels

	(mm)	(mm)	(mm)	(mm)	(Kg)
	680	460	656	770	
1	575	380	75		40
2	575	380	75		40
3	575	380	75		40
4	575	380	312		40



TSW26R4L

£1,020.00

26" PRO35™ LOW ROLLER CABINET 6 DRAWERS RED

- 6 Drawer
- 26" Wide Box
- 3-Piece Cabinet Frame
- Heavy Gauge Steel
- 5-Step Phosphate-Free Rust Protection
- Up To 40kg Drawer Loading Capacity
- 3-Step Ball Bearing Slides
- Comfort Grip Handle
- Combination Lock As Standard
- 4" x 1-1/4" Castor Wheels

	(mm)	(mm)	(mm)	(mm)	(Kg)
	680	460	656	770	
1	575	380	75		40
2	575	380	75		40
3	575	380	75		40
4	575	380	75		40
5	575	380	75		40
6	575	380	154		40



TSW26R6L

£1,084.00



PRO35™



26" PRO35™ ROLLER CABINET 6 DRAWERS RED

- 6 Drawer
- 26" Wide Box
- 3-Piece Cabinet Frame
- Heavy Gauge Steel
- 5-Step Phosphate-Free Rust Protection
- Up To 40kg Drawer Loading Capacity
- 3-Step Ball Bearing Slides
- Comfort Grip Handle
- Combination Lock As Standard
- 5" x 1-1/4" Castor Wheels

	(mm)	(mm)	(mm)	(mm)	(Kg)
	680	460	813	960	
1	575	380	75		40
2	575	380	75		40
3	575	380	75		40
4	575	380	75		40
5	575	380	75		40
6	575	380	312		40



TSW26R6

£1,234.00



PRO35™



26" PRO35™ ROLLER CABINET 7 DRAWERS RED

- 7 Drawer
- 26" Wide Box
- 3-Piece Cabinet Frame
- Heavy Gauge Steel
- 5-Step Phosphate-Free Rust Protection
- Up To 40kg Drawer Loading Capacity
- 3-Step Ball Bearing Slides
- Comfort Grip Handle
- Combination Lock As Standard
- 5" x 1-1/4" Castor Wheels

	(mm)	(mm)	(mm)	(mm)	(Kg)
	680	460	813	960	
1	575	380	75		40
2	575	380	75		40
3	575	380	75		40
4	575	380	75		40
5	575	380	75		40
6	575	380	154		40
7	575	380	154		40



TSW26R7

£1,229.00





PRO35™



26" PRO35™ ROLLER CABINET 9 DRAWERS RED

- 9** Drawer
- 3-Piece Cabinet Frame**
- 5-Step Phosphate-Free Rust Protection**
- 3-Step Ball Bearing Slides**
- Combination Lock As Standard**
- 26" Wide Box**
- Heavy Gauge Steel**
- Up To 40kg Drawer Loading Capacity**
- Comfort Grip Handle**
- 5" x 1-1/4" Castor Wheels**

	(mm)	(mm)	(mm)	(Kg)
	680	460	813	960
1	575	380	75	40
2	575	380	75	40
3	575	380	75	40
4	575	380	75	40
5	575	380	75	40
6	575	380	75	40
7	575	380	75	40
8	575	380	75	40
9	575	380	75	40



TSW26R9

£1,429.00



PRO35™



26" PRO35™ ROLLER CABINET 9 DRAWERS BLACK

- 9** Drawer
- 3-Piece Cabinet Frame**
- 5-Step Phosphate-Free Rust Protection**
- 3-Step Ball Bearing Slides**
- Combination Lock As Standard**
- 26" Wide Box**
- Heavy Gauge Steel**
- Up To 40kg Drawer Loading Capacity**
- Comfort Grip Handle**
- 5" x 1-1/4" Castor Wheels**

	(mm)	(mm)	(mm)	(Kg)
	680	460	813	960
1	575	380	75	40
2	575	380	75	40
3	575	380	75	40
4	575	380	75	40
5	575	380	75	40
6	575	380	75	40
7	575	380	75	40
8	575	380	75	40
9	575	380	75	40



TSW26B9

£1,429.00



37" PRO35™ ROLLER CABINET 7 DRAWERS RED

- 7 Drawer
- 37" Wide Box
- 3-Piece Cabinet Frame
- Heavy Gauge Steel
- 5-Step Phosphate-Free Rust Protection
- Up To 40kg Drawer Loading Capacity
- 3-Step Ball Bearing Slides
- Comfort Grip Handle
- Combination Lock As Standard
- 5" x 2" Castor Wheels

	(mm)	(mm)	(mm)	(mm)	(Kg)
	964	460	813	985	
1	860	380	75		25
2	860	380	75		25
3	860	380	75		25
4	860	380	75		25
5	860	380	75		25
6	860	380	154		40
7	860	380	154		40



TSW37R7

£1,729.00



37" PRO35™ ROLLER CABINET 8 DRAWERS BLACK

- 8 Drawer
- 37" Wide Box
- 3-Piece Cabinet Frame
- Heavy Gauge Steel
- 5-Step Phosphate-Free Rust Protection
- Up To 40kg Drawer Loading Capacity
- 3-Step Ball Bearing Slides
- Comfort Grip Handle
- Combination Lock As Standard
- 5" x 2" Castor Wheels

	(mm)	(mm)	(mm)	(mm)	(Kg)
	964	460	813	985	
1	860	380	75		25
2	860	380	75		25
3	860	380	75		25
4	860	380	75		25
5	860	380	75		25
6	860	380	75		25
7	860	380	75		25
8	860	380	154		40



TSW37B8

£1,834.00





PRO35™







53" PRO35™ ROLLER CABINET 9 DRAWERS RED

-  **9 Drawer**
-  **53" Wide Box**
-  **3-Piece Cabinet Frame**
-  **Heavy Gauge Steel**
-  **5-Step Phosphate-Free Rust Protection**
-  **Up To 40kg Drawer Loading Capacity**
-  **3-Step Ball Bearing Slides**
-  **Comfort Grip Handle**
-  **Combination Lock As Standard**
-  **6" x 2" Castor Wheels**



TSWS3R9

£3,349.00

	 (mm)	 (mm)	 (mm)	 (mm)	 (Kg)
	1350	460	813	993	
1	1215	380	160		40
2	575	380	75		40
3	575	380	75		40
4	575	380	75		40
5	575	380	75		40
6	575	380	75		40
7	575	380	75		40
8	575	380	154		40
9	575	380	154		40



PRO35™



64" PRO35™ ROLLER CABINET 15 DRAWERS RED

- 15 Drawer
- 64" Wide Box
- 3-Piece Cabinet Frame
- Heavy Gauge Steel
- 5-Step Phosphate-Free Rust Protection
- Up To 40kg Drawer Loading Capacity
- 3-Step Ball Bearing Slides
- Comfort Grip Handle
- Combination Lock As Standard
- 6" x 2" Castor Wheels



TSW64R15

£5,914.00

	(mm)	(mm)	(mm)	(Kg)
	1640	460	974	1153
1	1215	380	75	40
2	575	380	75	40
3	575	380	75	40
4	575	380	75	40
5	575	380	75	40
6	575	380	75	40
7	575	380	312	40
8	860	380	75	25
9	860	380	75	25
10	860	380	75	25
11	860	380	75	25
12	860	380	75	25
13	860	380	75	25
14	860	380	154	40
15	860	380	154	40





26" PRO35™ STACK TOOL STORAGE 16 DRAWERS RED

- 16 Drawer
- 26" Wide Box
- 3-Piece Cabinet Frame
- Heavy Gauge Steel
- 5-Step Phosphate-Free Rust Protection
- Up To 40kg Drawer Loading Capacity
- 3-Step Ball Bearing Slides
- Comfort Grip Handle
- Combination Lock As Standard
- 5" x 1-1/4" Castor Wheels

Contents:

Item ID	Description
TST26R4	26" PRO35™ Tool Chest 4 Drawers Red
TSM26R3	26" PRO35™ Tool Chest 3 Drawers Red
TSW26R9	26" PRO35™ Roller Cabinet 9 Drawers Red



TSS26R16 £2,276.00

26" PRO35™ STACK TOOL STORAGE 16 DRAWERS BLACK

- 16 Drawer
- 26" Wide Box
- 3-Piece Cabinet Frame
- Heavy Gauge Steel
- 5-Step Phosphate-Free Rust Protection
- Up To 40kg Drawer Loading Capacity
- 3-Step Ball Bearing Slides
- Comfort Grip Handle
- Combination Lock As Standard
- 5" x 1-1/4" Castor Wheels

Contents:

Item ID	Description
TST26B4	26" PRO35™ Tool Chest 4 Drawers Black
TSM26B3	26" PRO35™ Tool Chest 3 Drawers Black
TSW26B9	26" PRO35™ Roller Cabinet 9 Drawers Black



TSS26B16 £2,276.00



37" PRO35™ STACK TOOL STORAGE 12 DRAWERS RED

- 12 Drawer
- 37" Wide Box
- 3-Piece Cabinet Frame
- Heavy Gauge Steel
- 5-Step Phosphate-Free Rust Protection
- Up To 40kg Drawer Loading Capacity
- 3-Step Ball Bearing Slides
- Comfort Grip Handle
- Combination Lock As Standard
- 5" x 2" Castor Wheels

Contents:

Item ID	Description
TST37R5F	37" PRO35™ Tool Chest 5 Drawers Red
TSW37R7	37" PRO35™ Roller Cabinet 7 Drawers Red



TSS37R12 £3,164.00

53" PRO35™ STACK TOOL STORAGE 19 DRAWERS RED

- 19 Drawer
- 53" Wide Box
- 3-Piece Cabinet Frame
- Heavy Gauge Steel
- 5-Step Phosphate-Free Rust Protection
- Up To 40kg Drawer Loading Capacity
- 3-Step Ball Bearing Slides
- Comfort Grip Handle
- Combination Lock As Standard
- 6" x 2" Castor Wheels

Contents:

Item ID	Description
TST53R10F	53" PRO35™ Tool Chest 10 Drawers Red
TSW53R9	53" PRO35™ Roller Cabinet 9 Drawers Red



TSS53R19 £5,615.00



CLASSIC™



26" CLASSIC TOOL CHEST 4 DRAWER RED

- 4 Drawer
- 26" Wide Box
- 3-Step Ball Bearing Slides
- Heavy Gauge Steel
- 5-Step Phosphate-Free Rust Protection
- Up To 30kg Drawer Loading Capacity
- Key Lock

	(mm)	(mm)	(mm)	(Kg)
	660	305	380	
1	569	275	50	30
2	569	275	50	30
3	569	275	50	30
4	569	275	75	30

TC804EV £449.00

CLASSIC™



26" CLASSIC FULL DEPTH TOOL CHEST 5 DRAWERS RED

- 5 Drawer
- 26" Wide Box
- 3-Step Ball Bearing Slides
- Heavy Gauge Steel
- 5-Step Phosphate-Free Rust Protection
- Up To 30kg Drawer Loading Capacity
- Key Lock

	(mm)	(mm)	(mm)	(Kg)
	660	455	483	
1	575	380	50	30
2	575	380	50	30
3	575	380	75	30
4	575	380	75	30
5	575	380	75	30

TC805SV £867.00

CLASSIC™



26" CLASSIC TOOL CHEST 3 DRAWERS RED

- 3 Drawer
- 26" Wide Box
- 3-Step Ball Bearing Slides
- Heavy Gauge Steel
- 5-Step Phosphate-Free Rust Protection
- Up To 30kg Drawer Loading Capacity
- Key Lock

	(mm)	(mm)	(mm)	(Kg)
1	660	305	250	30
2	569	275	50	30
3	569	275	75	30



TC803SV

£329.00

CLASSIC™



26" CLASSIC CABINET 7 DRAWERS RED

- 7 Drawer
- 26" Wide Box
- 3-Piece Cabinet Frame
- Heavy Gauge Steel
- 5-Step Phosphate-Free Rust Protection
- Up To 30kg Drawer Loading Capacity
- 3-Step Ball Bearing Slides
- 5" x 1-1/4" Castor Wheels
- Key Lock

	(mm)	(mm)	(mm)	(Kg)
	680	460	813	960
1	575	380	75	30
2	575	380	75	30
3	575	380	75	30
4	575	380	75	30
5	575	380	75	30
6	575	380	154	30
7	575	380	154	30



TCW707EV

£999.00



TOOL STORAGE



26" PRO CABINET 7 SOFT CLOSE DRAWERS RED

- 7** Drawer
- 26" Wide Box**
- 3-Piece Cabinet Frame**
- Heavy Gauge Steel**
- 5-Step Phosphate-Free Rust Protection**
- Up To 30kg Drawer Loading Capacity**
- 3-Step Ball Bearing Slides**
- Comfort Grip Handle**
- Combination Lock As Standard**
- 5" x 1-1/4" Castor Wheels**

	(mm)	(mm)	(mm)	(Kg)
	670	460	813	960
1	575	380	75	30
2	575	380	75	30
3	575	380	75	30
4	575	380	75	30
5	575	380	75	30
6	575	380	150	30
7	575	380	150	30

TSCW907X £1,499.00



PRO35™



15" PRO35™ SIDE CABINET 1 DRAWER RED

	(mm)	(mm)	(mm)	(g)	(£)
TSC15R1	382	460	795	28700 g	£723.90



PRO35™



15" PRO35™ SIDE CABINET 7 DRAWERS RED

	(mm)	(mm)	(mm)	(g)	(£)
TSC15R7	382	460	795	38700 g	£967.90



PRO35™



PRO35™ SIDE CUPBOARD RED

TSC8R1D	400 (mm)	200 (mm)	500 (mm)	6000 g	£188.90



MECCA PRO™



MECCA PRO TC9 SERVICE CASE

TC-SC	560 (mm)	390 (mm)	200 (mm)	6400 g	£445.90



PRO35™



15" PRO35™ SIDE CABINET WITH DOOR RED

TSC15R1D	382 (mm)	460 (mm)	795 (mm)	22600 g	£571.90



MECCA PRO™



MECCA PRO TC-6 CARRYING CASE

TC-6T	468 (mm)	350 (mm)	130 (mm)	2840 g	£105.90



TOOL STORAGE



BARN STYLE TOOL BOX

TC450	450 (mm)	200 (mm)	200 (mm)	5500 g	£145.90



PLASTIC TOOL BOX

TCP445C	445 (mm)	240 (mm)	202 (mm)	1941 g	£66.90







BACK PACK TOOL BOX

TCSB	380 (mm)	230 (mm)	430 (mm)	1298 g	£153.50







TOOL BAG

					
TCSB16	430 (mm)	280 (mm)	330 (mm)	3569 g	£168.90



CANTILEVER TOOL BOX

					
TC540	570 (mm)	220 (mm)	340 (mm)	6566 g	£195.90



TOP BOX COVER RED

- Protective cover with the TengTools logo
- Fits TengTools 26" top boxes

		
TC-COVER	95 g	£24.90



CABINET COVER RED

- Protective cover with the TengTools logo
- Fits TengTools 26" roller cabinets

		
TC-WC02	259 g	£44.50









STACK COVER RED

- Protective cover with the TengTools logo
- Fits TengTools 26" stacks

	
TC-COVER1	376 g £62.40



NON SLIP MAT ROLL

					
TC-MAT	2000 (mm)	450 (mm)	2 (mm)	333 g	£22.90



DIVIDER SET SMALL

- Interlocking black metal dividers for use in top box size drawers
- A simple way to create a drawer with 9 separate compartments

	
TCDIVS	200 g £13.50

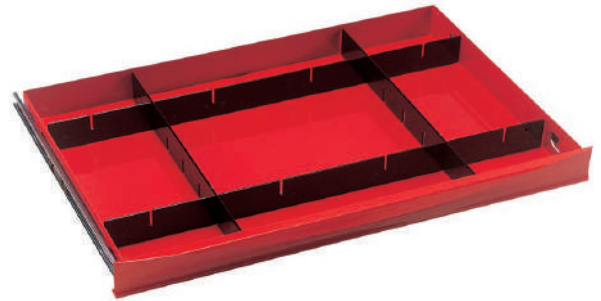

DIVIDER SET LARGE

- Interlocking black metal dividers for use in roller cabinet size drawers
- A simple way to create a drawer with 9 separate compartments

	
TCDIVL	230 g £13.50



TOOL BOX FIXING BRACKETS







List Price

		List Price
TCF01	Tool Box Fixing Brackets for 26" Middle Box	£13.10
TCF03	Tool Box Fixing Brackets for 53" Top Box	£59.90
TCF04	Tool Box Fixing Brackets for 26" & 37" Full Depth Top Box	£38.70
TCF05	Fixing brackets for PRO35 26" 3-drawer tool chest	£29.50
TCF06	Fixing brackets for PRO35 26" 4-drawer tool chest	£31.50
TCF07	Fixing brackets for PRO35 26", 37" & 53" deep tool chest	£37.90









MAGNETIC TRAY RED

	 (mm)	 (mm)	 (mm)			
580K	230	98	136	2	629 g	£73.90
580M	460	98	136	4	1164 g	£83.10
580N	640	98	136	6	1707 g	£97.40







MAGNETIC SHELF RED

	 (mm)	 (mm)	 (mm)		
580D	210	115	31	672 g	£46.80







MAGNETIC TRAY FOR CANS RED

	 (mm)	 (mm)	 (mm)			
580CM	460	98	136	4	1164 g	£83.10
580CN	640	98	136	6	1707 g	£97.40



MAGNETIC SIDE SHELF RED

	 (mm)	 (mm)	 (mm)		
580J	410	90	100	2004 g	£77.90

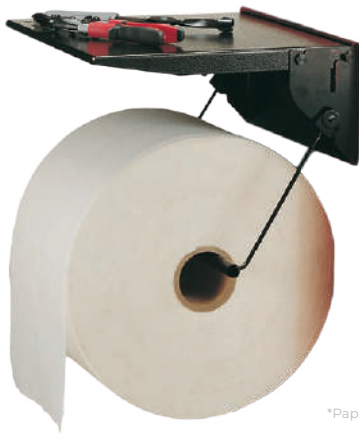

*Paper roll not included

PAPER ROLL HOLDER



TCA01	370	370	5500 g	£127.90
-------	-----	-----	--------	---------



SIDE SHELF FOR VICE



TCATV	385	203	166	3550 g	£117.90
-------	-----	-----	-----	--------	---------



*Paper roll not included

PAPER ROLL HOLDER FOR SIDE HANDLE



TCA08	360	384 g	£18.20
-------	-----	-------	--------



POWER TOOL SHELF



TCATP	375	280	55	2178 g	£73.60
-------	-----	-----	----	--------	--------





SIDE SHELF FOR ROLLER CABINET 457 X 100 X 50MM

580T	457 (mm)	100 (mm)	50 (mm)	1850 g	£54.90



CABLE TIE HOLDER TOOL CHEST ACCESSORY

TCCTH	203 (mm)	53 (mm)	275 (mm)	890 g	£43.90



CABLE HOOK TOOL CABINET ACCESSORY

TCCH	20 (mm)	100 (mm)	160 (mm)	172 g	£10.10



MAGNETS WITH ADHESIVE TAPE 2 PIECES

TC-MAG1	42 (mm)	42 (mm)	5 (mm)	65 g	£24.90



MAGNETIC TOOL RAIL

TC-MAG	457 (mm)	52 (mm)	17 (mm)	652 g	£41.50

REPLACEMENT LOCKS

Which lock to choose?

CLASSIC™

TCDRK	Replacement key lock for TengTools middle boxes and roller cabinets	£17.70
TCPRK	Spare Part For Locks Lock and Key 8-series	£19.90
Tool Box	Description	Key Lock
TC804EV	26" Classic Tool Chest 4 Drawer Red	TCPRK
TC805SV	26" Classic Full Depth Tool Chest 5 Drawers Red	TCPRK
TC803SV	26" Classic Tool Chest 3 Drawers Red	TCDRK
TCW707EV	26" Classic Cabinet 7 Drawers Red	TCDRK
TSC8R1D	PRO35™ Side Cupboard Red	TCPRK

REPLACEMENT LOCKS

Which lock to choose?

PRO35™

ALL PRO35™ STORAGE (EXCEPT TSC8R1) CAN BE FITTED WITH A COMBINATION LOCK OR KEY LOCK



TC-90CLOCK	Spare Part For Locks Combination Lock 90°	£29.30
TC-90KEYLOCK	Spare Part For Locks Key Lock 90°	£22.60
TC-180KEYLOCK	Spare Part For Locks Key Lock 180°	£22.60
TC-180LOCK	Spare Part - Key Lock 180°	£29.30

Tool Box	Description	Combination Lock	Key Lock
TSC15R1	15" PRO35™ side cabinet 1 drawer	TC-180CLOCK	TC-180KEYLOCK
TSC15R1D	15" PRO35™ Side Cabinet	TC-90CLOCK	TC-90KEYLOCK
TSC15R7	15" PRO35™ side cabinet 7 drawers	TC-180CLOCK	TC-180KEYLOCK
TSM26B3	26" PRO35™ tool chest 3 drawers	TC-180CLOCK	TC-180KEYLOCK
TSM26R3	26" PRO35™ tool chest 3 drawers	TC-180CLOCK	TC-180KEYLOCK
TST26B4	26" PRO35™ tool chest 4 drawers	TC-90CLOCK	TC-90KEYLOCK
TST26B4P	26" PRO35™ tool chest 4 drawers	TC-90CLOCK	TC-90KEYLOCK
TST26R4	26" PRO35™ tool chest 4 drawers	TC-90CLOCK	TC-90KEYLOCK
TST26R5F	26" PRO35™ deep tool chest 5 drawers	TC-90CLOCK	TC-90KEYLOCK
TST37R5F	37" PRO35™ tool chest 5 drawers	TC-90CLOCK	TC-90KEYLOCK
TST53R10F	53" PRO35™ tool chest 10 drawers	TC-90CLOCK	TC-90KEYLOCK
TSW26B9	26" PRO35™ roller cabinet 9 drawers	TC-180CLOCK	TC-180KEYLOCK
TSW26R4L	26" PRO35™ low roller cabinet	TC-180CLOCK	TC-180KEYLOCK
TSW26R6	26" PRO35™ roller cabinet 6 drawers	TC-180CLOCK	TC-180KEYLOCK
TSW26R6L	26" PRO35™ low roller cabinet	TC-180CLOCK	TC-180KEYLOCK
TSW26R7	26" PRO35™ roller cabinet 7 drawers	TC-180CLOCK	TC-180KEYLOCK
TSW26R9	26" PRO35™ roller cabinet 9 drawers	TC-180CLOCK	TC-180KEYLOCK
TSW37B8	37" PRO35™ roller cabinet 8 drawers	TC-180CLOCK	TC-180KEYLOCK
TSW37R7	37" PRO35™ roller cabinet 7 drawers	TC-180CLOCK	TC-180KEYLOCK
TSW53R9	53" PRO35™ roller cabinet 9 drawers	TC-180CLOCK	TC-180KEYLOCK
TSW64R15	64" PRO35™ roller cabinet 15 drawers	TC-180CLOCK	TC-180KEYLOCK



TOOL STORAGE

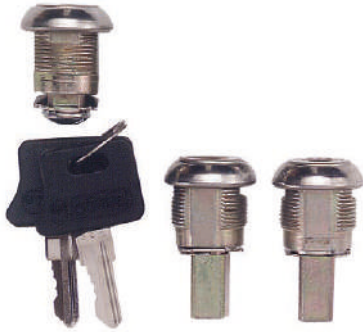

SPARE PART FOR LOCKS ONE KEY THREE LOCKS



TC-LOCK3

£40.00



SIDE PANEL FOR CABINET



TCW-SP01



456 (mm)



25 (mm)



805 (mm)



4800 g

£121.90



SPARE PART FOR LOCKS ONE KEY FIVE LOCKS



TC-LOCKS

£54.00

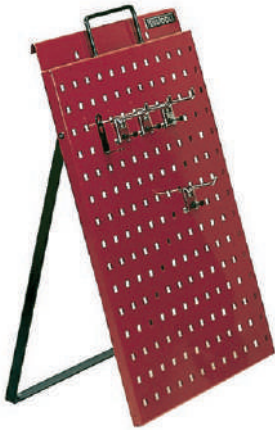

*Hooks not included

SIDE PANEL WITH STAND

TCW-SP	460 (mm)	25 (mm)	640 (mm)	5190 g	£118.90



SOCKET CLIP RAIL

		List Price
ALU430	Socket Clip Rail 430mm Single Track	£10.00
ALU1000-4	Socket Clip Rail 1m Four Tracks	£31.80



TOOL HOOKS

		List Price
TCW-HK02	Tool Hooks 10 x Double Hooks	£23.10
TCW-HK03	Tool Hooks 6 x 90°, 6 x 45° & 8 x Double Hooks	£40.90
TCW-HK10	Tool Hooks 7 x 90° & 3 x 45°	£22.30
TCW-HK45	Tool Hooks 10 x 45°	£22.80
TCW-HK90	Tool Hooks 10 x 90°	£22.40



SOCKET CLIPS





		List Price
ALU12	Socket Clips 10 x 1/2"	£7.70
ALU14	Socket Clips 10 x 1/4"	£7.70
ALU34	Socket Clips 10 x 3/4"	£8.50
ALU38	Socket Clips 10 x 3/8"	£7.70



TOOL STORAGE



HOOK ON TRAY

	 (mm)	 (mm)	 (mm)		
TCT01	230	101	139	450 g	£55.90
TCT02	460	101	139	846 g	£59.90
TCT03	640	101	139	1138 g	£71.30



*T-bar not included





HOOK ON TOOL HOLDER

- Hook tool holder for tool panels
- Designed to hook in to the square holes on TengTools wall and side panels and wall cabinets
- Ideal for storing tools such as T bars etc

		
TCT04	319 g	£47.20



HOOK ON TRAY FOR CANS

	 (mm)	 (mm)	 (mm)			
TCC02	460	98	136	4	831 g	£56.50
TCC03	640	98	136	6	1128 g	£65.50







ABS TOP FOR 26" CABINET

- ABS tray designed to fit the top of TengTools standard width (26"/660mm) cabinets
- Individual parts areas plus positioning for a middle box or top box to give a very organised work area
- Protects the top of the roller cabinet from scratches and marks

		
ABS-TOP		£33.90





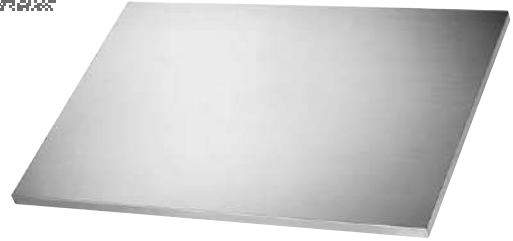

37 MM THICK WORKTOP FOR CABINETS

						
		(mm)	(mm)	(mm)		
TC-TB01	Work Top for 53" Cabinet	1354	460	37	16500 g	£329.00
TC-TB02	Work Top for 26" Cabinet	672	460	37	8390 g	£177.00







STAINLESS STEEL WORK TOP

						
		(mm)	(mm)	(mm)		
TC-TBS02	Stainless steel work top for 26" cabinet	665	454	20	5800 g	£224.90
TC-TBS04	Stainless steel work top for 37" cabinet	943	454	20	8160 g	£305.90







18 MM LAMINATED WORK TOP

						
		(mm)	(mm)	(mm)		
TC-TB03	18 mm laminated work top for 37" roller cabinet	372	454	18	5800 g	£199.00
TC-TB05	18 mm laminated work top for 26" roller cabinet	663	454	18	4230 g	£135.00
TC-TB06	18 mm laminated work top for 53" roller cabinet	948	455	18	8580 g	£263.00
TC-TB07	18 mm laminated work top for 64" roller cabinet	1340	454	18	10420 g	£310.00
TC-TB08	18 mm laminated work top for side cabinet	1623	454	18	2340 g	£94.90



5 MM EVA TOP FOAM FOR ROLLER CABINET

						
		(mm)	(mm)	(mm)		
EVA-453660	5 mm EVA top foam for 26" roller cabinet	946	453	5	365 g	£18.30
EVA-453946	5 mm EVA top foam for 37" roller cabinet	453	660	5	523 g	£23.80



TOOL STORAGE



*Tool Cabinet not included



*Tool Cabinet not included

TOOL PANEL SETS



TC-S01	Tool Panel Set for 26" Cabinet	£549.00
TC-SL01	Tool Panel Set for 53" Cabinet	£549.00

ADD ON PANEL SET BETWEEN CABINETS



TC-S02	Add On Panel Set for 26" Cabinet	£497.00
TC-SL02	Add On Panel Set for 53" Cabinet	£789.00

ADD ON PANEL SPARE PARTS



TC-160UR	Upright 1.6m	£219.90
TC-FB01	Fixing Bar for 26" Cabinet	£19.20
TC-FB02	Fixing Bar for 53" Cabinet	£29.70
TC-FB03	Fixing Bar for 37" Cabinet	£22.50
TC-H01	Header for 26" Cabinet	£29.80
TC-H02	Header for 53" Cabinet	£42.60
TC-H05	Header for 37" Cabinet	£36.00
TC-LBK	L Bracket	£52.50
TC-LEG	Support Leg	£110.90



TC-PA01	Tool Panel for 26" Cabinet	£96.90
TC-PA02	Tool Panel for 53" Cabinet	£175.90
TC-PA03	Tool Panel for 37" Cabinet	£133.50
TC-UPRL	Upright Long Cabinet Left	£72.90
TC-UPRLS	Upright Short Left	£62.80
TC-UPRR	Upright Long Cabinet Right	£72.90
TC-UPRRS	Upright Short Right	£62.80



*Tool Cabinet not included

ADD ON PANEL SET BESIDE CABINET



TC-S03AL	Add On Panel Set Left for 26" Cabinet	£649.00
TC-S03AR	Add On Panel Set Right for 26" Cabinet	£649.00
TC-SL03AL	Add On Panel Set Left for 53" Cabinet	£984.00
TC-SL03AR	Add On Panel Set Right for 53" Cabinet	£984.00

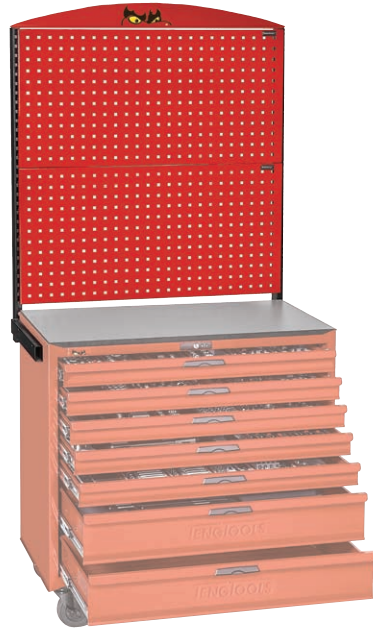

*Tool Cabinet not included

ADD ON PANEL SET FOR 37" CABINET



TC-S03	Add On Panel Set 37" 2 Panels	£439.90
TC-S04	Add On Panel Set 37" 1 Panel	£319.00





*Tool Cabinet not included

MOBILE TOOL PANEL



TPM01	Mobile Tool Panel 2 Panels	£607.00
TPM02	Mobile Tool Panel 4 Panels	£759.00



TROLLEY FOR TOP BOX

- Frame with a set of 4 wheels for TengTools regular top boxes
- Creates a mobile tool box
- Especially useful if the tool box is heavily laden with tools



TCTMC

£112.50



TROLLEY FOR SIDE CABINET

- Frame with a set of 4 wheels for TengTools side cabinets
- Creates a mobile tool box or storage unit
- Especially useful if the cabinet is heavily laden







TCSMC

£101.90







TOOL CABINET

		 (mm)	 (mm)	 (mm)		
TCB80		660	600	305	15000 g	£571.00







WORK BENCH

		 (mm)	 (mm)	 (mm)		
TWB1500		1500	800	927	60374 g	£729.00
TWB2000		2000	800	927	72640 g	£911.00



WALL HANGING TOOL CABINET 1800 MM

		 (mm)	 (mm)	 (mm)		
TCB180		1800	700	200	50000 g	£2,009.00

WORKBENCH SPARE PARTS

		
TWB-15SQ	Work Bench Square Tube 2000mm	£33.90
TWB-15TOP	Work Bench Work Top 1500mm	£509.00
TWB-20SQ	Work Bench Square Tube 1500mm	£38.50
TWB-20TOP	Work Bench Work Top 2000mm	£662.00
TWB-4WD	Work Bench Wheel Set	£132.50
TWB-FB	Work Bench Fixing Bar	£31.90
TWB-LEG	Work Bench Legs	£316.00
TWB-PA	Work Bench Panel	£115.90
TWB-UPR	Work Bench Upright	£53.20



SOCKET SETS

ALWAYS READY FOR ACTION







Tengtools socket sets are designed with a focus on quality, durability, and accessibility. We use high-grade materials such as chrome vanadium steel for sockets, and offer a wide range of sizes in both metric and AF measurements.

The sockets are clearly marked and easy to identify, and the sets are compatible with different types of ratchets and extensions.

MECCA PRO™

SOCKET SETS

IN DURABLE, SHOCKPROOF CASES

-  Secure lock system with click mechanism so you know the top is closed properly
-  Hard-wearing hinge with metal pin for increased life
-  Retractable handle, especially designed for comfort and durability.
-  Clear layout makes it easier to see which tools are missing
-  Rubber feet to prevent the box from sliding and which protects against scratching
-  Fully recyclable packaging that helps the environment



SOCKET SETS



1/4" SOCKET SET 6 PT 13 PIECES

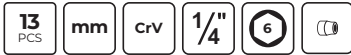

- » 1/4" Ratchet FRP 45 Teeth
- » 1/4" Extension Bar 50 mm
- » 1/4" Socket 6 pt Metric
- » 4, 5, 5.5, 6, 7, 8, 9, 10, 11, 12, 13

		
M1413N1	300 g	£65.50



1/4" SOCKET SET 6 PT WITH BELT CLIP 19 PIECES



- » 1/4" Mini Bits Ratchet
- » 1/4" Magnetic Bit Holder 50 mm
- » 1/4" Flat Bits 25 mm
- » 0.6×4.5, 0.8×5.5, 1.2×6.5
- » 1/4" Hex Bits 25 mm
- » 4, 5, 6
- » Hex Socket Adaptor 1/4" Hex - 1/4" 25 mm
- » 1/4" Socket 6 pt Metric
- » 8, 9, 10, 11, 12, 13
- » 1/4" PH Bits 25 mm
- » PH1, PH2
- » 1/4" PZ Bits 25 mm
- » PZ1, PZ2

		
TJ1419	275 g	£62.80



1/4" SOCKET SET 6 PT WITH BELT CLIP 20 PIECES



- » 1/4" Mini Bits Ratchet
- » 1/4" Magnetic Bit Holder 50 mm
- » 1/4" Flat Bits 25 mm
 - » 0.6×4.5, 0.8×5.5, 1.2×6.5
- » Hex Socket Adaptor 1/4" Hex - 1/4" 25 mm
- » 1/4" Socket 6 pt Metric
 - » 5.5, 6, 7, 8, 9, 10, 13
- » 1/4" PH Bits 25 mm
 - » PH1, PH2
- » 1/4" PZ Bits 25 mm
 - » PZ1, PZ2
- » 1/4" TX Bits 25 mm
 - » TX10, TX15, TX20



TJ1420 271 g £65.20



1/4" SOCKET SET 6 PT 22 PIECES

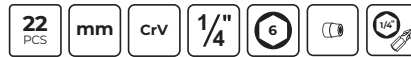

- » 1/4" Ratchet 72 Teeth IP5X
- » 1/4" Flat Bits 25 mm
 - » 0.6×4.5, 0.8×5.5, 1.2×6.5
- » 1/4" Extension Bar 50 mm
- » 1/4" Bit Adaptor Hex Bit Coupler
- » 1/4" Socket 6 pt Metric
 - » 4, 5, 5.5, 6, 7, 8, 10, 12, 13
- » 1/4" PH Bits 25 mm
 - » PH1, PH2
- » 1/4" PZ Bits 25 mm
 - » PZ1, PZ2
- » 1/4" TX Bits 25 mm
 - » TX10, TX15, TX20



T1422 432 g £89.70



1/4" SOCKET SET 6 PT 8 PIECES



- » 1/4" Mini Ratchet 72 Teeth
- » 1/4" Socket 6 pt Metric
 - » 5.5, 6, 7, 8, 10, 12, 13



T1408 229 g £60.10



SOCKET SETS



1/4" SOCKET SET 6 PT 23 PIECES



- » 1/4" Mini Bits Ratchet
- » Adjustable Wrench 100 mm
- » 1/4" Flat Bits 25 mm
 - » 0.8x4.0, 0.8x5.5, 1.2x6.5
- » 1/4" Extension Bar 50 mm
- » Hex Socket Adaptor 1/4" Hex - 1/4" 25 mm
- » 1/4" Socket 6 pt Metric
 - » 4, 5, 5.5, 6, 7, 8, 10, 12, 13
- » 1/4" PH Bits 25 mm
 - » PH1, PH2
- » 1/4" PZ Bits 25 mm
 - » PZ1, PZ2
- » 1/4" TX Bits 25 mm
 - » TX10, TX15, TX20



T1423

432 g

£84.60



1/4" SOCKET SET 6 PT 24 PIECES

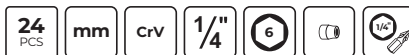

- » 1/4" Ratchet FRP 45 Teeth
- » 1/4" Flat Bits 25 mm
 - » 0.8x4.0, 0.8x5.5
- » 1/4" Hex Bits 25 mm
 - » 3, 5, 6
- » 1/4" Extension Bar 75 mm
- » 1/4" Universal Joint
- » 1/4" Bit Adaptor Hex Bit Coupler
- » 1/4" Socket 6 pt Metric
 - » 4, 5, 5.5, 6, 7, 8, 10, 11, 12, 13
- » 1/4" PH Bits 25 mm
 - » PH1, PH2
- » 1/4" TX Bits 25 mm
 - » TX10, TX15, TX20



T1424

374 g

£68.30



1/4" SOCKET SET 6 PT AF 35 PIECES



- » 1/4" Ratchet FRP 45 Teeth
- » Hex Key Metric
 - » 1.5, 2, 2.5
- » 1/4" Flat Bits 25 mm
 - » 0.8×4.0, 0.8×5.5
- » 1/4" Hex Bits 25 mm
 - » 5, 6
- » 1/4" Extension Bar 50 mm
- » 1/4" Extension Bar 100 mm
- » 1/4" Universal Joint
- » 1/4" Bit Adaptor Hex Bit Coupler
- » 1/4" Socket 6 pt AF
 - » 3/16, 7/32, 1/4, 9/32, 5/16, 11/32, 3/8, 7/16, 1/2
- » 1/4" Deep Socket 6 pt AF
 - » 3/16, 1/4, 5/16, 3/8, 7/16, 1/2
- » 3/8" Drive Adaptor 3/8"F:1/4"M with 1/4" hole
- » 1/4" PH Bits 25 mm
 - » PH1, PH2
- » 1/4" PZ Bits 25 mm
 - » PZ1, PZ2
- » 1/4" TX Bits 25 mm
 - » TX10, TX15, TX20



T1435AF

892 g

£97.90



1/4" SOCKET SET 6 PT 36 PIECES



- » 1/4" Ratchet FRP 45 Teeth
- » Hex Key Metric
 - » 1.5, 2, 2.5
- » 1/4" Flat Bits 25 mm
 - » 0.8×4.0, 0.8×5.5
- » 1/4" Hex Bits 25 mm
 - » 5, 6
- » 1/4" Extension Bar 50 mm
- » 1/4" Extension Bar 100 mm
- » 1/4" Universal Joint
- » 1/4" Bit Adaptor Hex Bit Coupler
- » 1/4" Socket 6 pt Metric
 - » 4, 5, 5.5, 6, 7, 8, 10, 11, 12, 13
- » 1/4" Deep Socket 6 pt Metric
 - » 6, 7, 8, 10, 12, 13
- » 3/8" Drive Adaptor 3/8"F:1/4"M with 1/4" hole
- » 1/4" PH Bits 25 mm
 - » PH1, PH2
- » 1/4" PZ Bits 25 mm
 - » PZ1, PZ2
- » 1/4" TX Bits 25 mm
 - » TX10, TX15, TX20



T1436

902 g

£90.90



SOCKET SETS



MECCA PRO 1/4" SOCKET SET 6 PT 60 PIECES



- » 1/4" Ratchet FRP 45 Teeth
- » 1/4" Flat Bits 25 mm
 - » 0.8x4.0, 0.8x5.5
- » 1/4" Hex Bits 25 mm
 - » 5, 6
- » 1/4" Spinner Handle
- » 1/4" Extension Bar 50 mm
- » 1/4" Extension Bar 100 mm
- » 1/4" Universal Joint
- » 1/4" Sliding T Bar
- » 1/4" Bit Adaptor Hex Bit Coupler
- » 1/4" Socket 6 pt AF
 - » 3/16, 7/32, 1/4, 9/32, 5/16, 11/32, 3/8, 7/16, 1/2
- » 1/4" Deep Socket 6 pt AF
 - » 1/4, 5/16, 3/8, 7/16, 1/2
- » 1/4" Socket 6 pt Metric
 - » 4, 4.5, 5, 5.5, 6, 7, 8, 9, 10, 11, 12, 13
- » 1/4" Deep Socket 6 pt Metric
 - » 6, 7, 8, 10, 12, 13
- » 1/4" TX Bit Socket
 - » 10, 15, 20, 25, 27
- » 1/4" PH Bit Socket
 - » PH1, PH2
- » 1/4" Flat Bit Socket
 - » 4, 5.5, 7
- » 1/4" PH Bits 25 mm
 - » PH1, PH2
- » 1/4" PZ Bits 25 mm
 - » PZ1, PZ2
- » 1/4" TX Bits 25 mm
 - » TX10, TX15, TX20

T1460	2012 g	£204.90



1/4" SOCKET CLIP RAIL SET 6 PT 12 PIECES



»	4, 4.5, 5, 5.5, 6, 7, 8, 9, 10, 11, 12, 13	
M1412	186 g	£33.90



1/4" DEEP SOCKET CLIP RAIL SET 6 PT 9 PIECES



»	4, 5, 6, 7, 8, 9, 10, 12, 13	
M1407	292 g	£35.50



1/4" HEX BIT SOCKET CLIP RAIL SET 9 PIECES



» 3, 4, 5, 5.5, 6, 7, 8, 10, 12		
M1409HN	165 g	£43.50



3/8" SOCKET SET 6 PT 12 PIECES

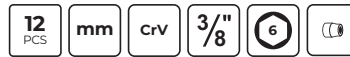

» 3/8" Ratchet FRP 45 Teeth		
» 3/8" Extension Bar 75 mm		
» 3/8" Socket 6 pt Metric		
» 8, 10, 11, 12, 13, 14, 15, 16, 17, 19		
M3812N1	611 g	£75.60



1/4" TX BIT SOCKET CLIP RAIL SET 7 PIECES



» 10, 15, 20, 25, 27, 30, 40		
M1408TX	91 g	£30.50



SOCKET SETS



3/8" SOCKET SET 6 PT 34 PIECES

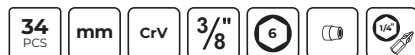

- » 3/8" Ratchet FRP 45 Teeth
- » 1/4" Flat Bits 25 mm
 - » 0.5 x 3.0, 0.8x4.0, 0.8x5.5
- » 1/4" Hex Bits 25 mm
 - » 3, 4, 5, 6
- » Reducing Adaptor 1/2"F - 3/8"M
- » 3/8" Extension Bar 75 mm
- » 3/8" Extension Bar 150 mm
- » 3/8" Bit Adaptor Hex bit coupler 1/4" Hex
- » 3/8" Socket 6 pt Metric
 - » 8, 10, 11, 12, 13, 14, 15, 17, 19
- » 1/4" PH Bits 25 mm
 - » PH1, PH2, PH3
- » 1/4" PZ Bits 25 mm
 - » PZ1, PZ2, PZ3
- » 1/4" TX Bits 25 mm
 - » TX10, TX15, TX20, TX25, TX27, TX30, TX40



T3834

1182 g

£97.90



MECCA PRO 3/8" SOCKET SET 6 PT AF 35 PIECES

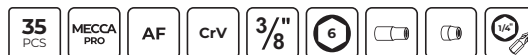

- » 3/8" Ratchet FRP 45 Teeth
- » 1/4" Flat Bits 25 mm
 - » 0.8x4.0, 0.8x5.5
- » 1/4" Hex Bits 25 mm
 - » 5, 6
- » Reducing Adaptor 1/2"F - 3/8"M
- » 3/8" Wobble Extension Bar 75 mm
- » 3/8" Extension Bar 150 mm
- » 3/8" Universal Joint
- » 3/8" Spark Plug Socket
 - » 16, 21
- » 3/8" Bit Adaptor Hex bit coupler 1/4" Hex
- » 3/8" Socket 6 pt AF
 - » 5/16, 3/8, 7/16, 1/2, 9/16, 5/8, 11/16, 3/4, 13/16, 7/8
- » 3/8" Deep Socket 6 pt AF
 - » 3/8, 7/16, 1/2, 9/16, 11/16, 3/4
- » 1/4" PH Bits 25 mm
 - » PH1, PH2
- » 1/4" PZ Bits 25 mm
 - » PZ1, PZ2
- » 1/4" TX Bits 25 mm
 - » TX10, TX15, TX20



T3835AF

2580 g

£178.50



MECCA PRO 3/8" SOCKET SET 6 PT 39 PIECES

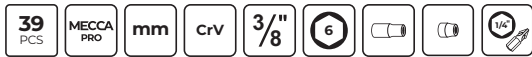

- » 3/8" Ratchet FRP 45 Teeth
- » 1/4" Flat Bits 25 mm
 - » 0.8x4.0, 0.8x5.5
- » 1/4" Hex Bits 25 mm
 - » 5, 6
- » Reducing Adaptor 1/2" F - 3/8" M
- » 3/8" Wobble Extension Bar 75 mm
- » 3/8" Extension Bar 150 mm
- » 3/8" Universal Joint
- » 3/8" Spark Plug Socket
 - » 16, 21
- » 3/8" Bit Adaptor Hex bit coupler 1/4" Hex
- » 3/8" Socket 6 pt Metric
 - » 8, 9, 10, 11, 12, 13, 14, 15, 16, 17, 18, 19, 21, 22
- » 3/8" Deep Socket 6 pt Metric
 - » 8, 10, 12, 13, 17, 19
- » 1/4" PH Bits 25 mm
 - » PH1, PH2
- » 1/4" PZ Bits 25 mm
 - » PZ1, PZ2
- » 1/4" TX Bits 25 mm
 - » TX10, TX15, TX20



T3839 2623 g £158.90



MECCA PRO 3/8" SOCKET & TOOL SET 39 PIECES



- » 3/8" Ratchet FRP 45 Teeth
- » Combination Spanner Metric
 - » 8, 10, 11, 12, 13, 14, 15, 17, 19
- » 1/4" Flat Bits 25 mm
 - » 0.8x4.0, 0.8x5.5
- » 1/4" Hex Bits 25 mm
 - » 5, 6
- » Reducing Adaptor 1/2" F - 3/8" M
- » 3/8" Extension Bar 150 mm
- » 3/8" Universal Joint
- » 3/8" Bit Adaptor Hex bit coupler 1/4" Hex
- » 3/8" Socket 6 pt Metric
 - » 8, 9, 10, 11, 12, 13, 14, 15, 16, 17, 18, 19, 21, 22
- » 1/4" PH Bits 25 mm
 - » PH1, PH2
- » 1/4" PZ Bits 25 mm
 - » PZ1, PZ2
- » 1/4" TX Bits 25 mm
 - » TX10, TX15, TX20



T3840 2649 g £214.90



SOCKET SETS



MECCA PRO 3/8" SOCKET & TOOL SET MM/AF 48 PIECES



- » 3/8" Ratchet FRP 45 Teeth
- » Adjustable Wrench 200 mm
- » Curved Jaw Power Grip Plier 190 mm
- » Combination Spanner AF
 - » 7/16, 1/2, 9/16, 11/16
- » Combination Spanner Metric
 - » 8, 10, 12, 13, 14, 15, 16, 17, 18, 19
- » Reducing Adaptor 1/2" F - 3/8" M
- » 3/8" Extension Bar 75 mm
- » 3/8" Extension Bar 150 mm
- » 3/8" Universal Joint
- » 3/8" Spark Plug Socket
 - » 16, 21
- » 3/8" Bit Adaptor Hex bit coupler 1/4" Hex
- » 3/8" Socket 6 pt AF
 - » 7/16, 1/2, 9/16, 11/16
- » 3/8" Socket 6 pt Metric
 - » 8, 10, 12, 13, 14, 15, 16, 17, 18, 19
- » Side Cutting Plier TPR Grip 160 mm
- » Heavy Duty Combination Plier TPR Grip 190 mm
- » Long Nose Plier TPR Grip 205 mm
- » Water Pump Plier TPR Grip 250 mm
- » Flat Screwdriver
 - » 0.5x3.0, 1.0x5.5, 1.2x6.5
- » PH Screwdriver
 - » PH0, PH1, PH2



T3848

6391 g

£505.00



MECCA PRO 3/8" SOCKET & TOOL SET 67 PIECES



- » 3/8" Ratchet FRP 45 Teeth
- » Combination Spanner Metric
 - » 8, 10, 11, 12, 13, 14, 15, 16, 17, 19
- » 1/4" Flat Bits 25 mm
 - » 0.8x4.0, 0.8x5.5, 1.4x7.0
- » 1/4" Hex Bits 25 mm
 - » 3, 4, 5, 6, 8, 10
- » Reducing Adaptor 1/2" F - 3/8" M
- » 3/8" Extension Bar 75 mm
- » 3/8" Extension Bar 150 mm
- » 3/8" Universal Joint
- » 3/8" Bit Adaptor Hex bit coupler 1/4" Hex
- » 3/8" Socket 6 pt Metric
 - » 8, 9, 10, 11, 12, 13, 14, 15, 16, 17, 18, 19, 20, 22
- » Side Cutting Plier 160 mm
- » Heavy Duty Combination Plier 185 mm
- » Long Nose Plier 200 mm
- » Water Pump Plier 240 mm
- » Flat Screwdriver
 - » 0.5x3.0, 1.0x5.5, 1.2x6.5
- » PH Screwdriver
 - » PH0, PH1, PH2
- » 1/4" PH Bits 25 mm
 - » PH0, PH1, PH2, PH3
- » 1/4" PZ Bits 25 mm
 - » PZ1, PZ2, PZ3
- » 1/4" TX Bits 25 mm
 - » TX8, TX10, TX15, TX20, TX25, TX27, TX30, TX40, TX45, TX50



T3867

5482 g

£434.00



3/8" SOCKET CLIP RAIL SET 6 PT 16 PIECES



» 7, 8, 9, 10, 11, 12, 13, 14, 15, 16, 17, 18, 19, 20, 21, 22		
M3816	570 g	£66.20



3/8" HEX BIT SOCKET CLIP RAIL SET 9 PIECES



» 3, 4, 5, 5.5, 6, 7, 8, 10, 12		
M3812	420 g	£61.70



3/8" DEEP SOCKET CLIP RAIL SET 6 PT 7 PIECES



» 10, 12, 13, 14, 15, 17, 19		
M3807	548 g	£42.40



3/8" LONG HEX BIT SOCKET CLIP RAIL SET 9 PIECES



» 3, 4, 5, 5.5, 6, 7, 8, 10, 12		
M3809	616 g	£93.90



SOCKET SETS



3/8" LONG HEX BIT SOCKET BALL POINT CLIP RAIL SET 9 PIECES



☰		
»	3, 4, 5, 5.5, 6, 7, 8, 10, 12	
M3809HBN	619 g	£92.90



3/8" TPX BIT SOCKET CLIP RAIL SET 9 PIECES



☰		
»	TPX10, TPX15, TPX20, TPX25, TPX27, TPX30, TPX40, TPX45, TPX50	
M3813TPX	376 g	£60.90



3/8" HEX BIT SOCKET CLIP RAIL SET AF 8 PIECES

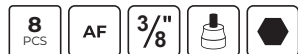

☰		
»	3/32, 1/8, 5/32, 3/16, 7/32, 1/4, 5/16, 3/8	
M3811	308 g	£61.50



3/8" TX BIT SOCKET CLIP RAIL SET 9 PIECES



☰		
»	TX10, TX15, TX20, TX25, TX27, TX30, TX40, TX45, TX50	
M3813TX	424 g	£60.90



3/8" LONG TX BIT SOCKET CLIP RAIL SET 9 PIECES



» TX10, TX15, TX20, TX25, TX27, TX30, TX40, TX45, TX50

M3809TX	503 g	£94.10



3/8" LONG RIBE® BIT SOCKET CLIP RAIL SET 6 PIECES



» 4, 5, 6, 8, 9, 10

M3806	356 g	£66.90



1/4" & 3/8" TX-E SOCKET CLIP RAIL SET 10 PIECES



» 1/4" TX-E Socket
 » E4, E5, E6, E7, E8
 » 3/8" TX-E Socket
 » E10, E12, E14, E16, E18

M3814	260 g	£41.90



3/8" CROW FOOT WRENCH CLIP RAIL SET 8 PIECES



» 10, 11, 12, 13, 16, 17, 18, 19

M3808MM	324 g	£101.90



SOCKET SETS



1/2" SOCKET SET 12 PT 12 PIECES



- » 1/2" Ratchet FRP 45 Teeth
- » 1/2" Extension Bar 125 mm
- » 1/2" Socket 12 pt Metric
- » 8, 10, 12, 13, 14, 15, 17, 18, 19, 24



M1212N1

1335 g

£112.10



MECCA PRO 1/2" SOCKET SET 12 PT 21 PIECES



- » 1/2" Ratchet FRP 45 Teeth
- » 1/2" Extension Bar 63.5 mm
- » 1/2" Extension Bar 150 mm
- » 1/2" Universal Joint
- » 1/2" Socket 12 pt Metric
- » 10, 11, 12, 13, 14, 15, 16, 17, 18, 19, 21, 22, 24, 27, 30, 32
- » Step Up Adaptor 3/8"F - 1/2"M



T1221

3211 g

£198.00



MECCA PRO 1/2" SOCKET SET 12 PT AF 20 PIECES



- » 1/2" Ratchet FRP 45 Teeth
- » 1/2" Extension Bar 63.5 mm
- » 1/2" Extension Bar 150 mm
- » 1/2" Universal Joint
- » 1/2" Socket 12 pt AF
- » 3/8, 7/16, 1/2, 9/16, 5/8, 11/16, 3/4, 13/16, 7/8, 15/16, 1, 11/16, 11/8, 1 3/16, 1 1/4
- » Step Up Adaptor 3/8"F - 1/2"M



T1220AF

3311 g

£207.00



MECCA PRO 1/2" SOCKET SET 6 PT 21 PIECES

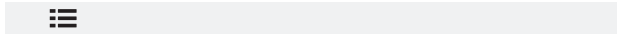

- » 1/2" Ratchet FRP 45 Teeth
- » 1/2" Extension Bar 63.5 mm
- » 1/2" Extension Bar 150 mm
- » 1/2" Universal Joint
- » 1/2" Socket 6 pt Metric
- » 10, 11, 12, 13, 14, 15, 16, 17, 18, 19, 21, 22, 24, 27, 30, 32
- » Step Up Adaptor 3/8"F - 1/2"M

T1221-6	3286 g	£198.00



MECCA PRO 1/2" SOCKET SET 6 PT 34 PIECES

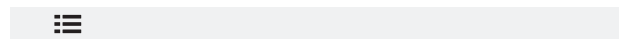

- » 1/2" Ratchet FRP 45 Teeth
- » Hex Key Metric
- » 1.5, 2, 2.5
- » 1/2" Extension Bar 125 mm
- » 1/2" Extension Bar 255 mm
- » 1/2" Universal Joint
- » 1/2" Spark Plug Socket
- » 16, 21
- » 1/2" Socket 6 pt Metric
- » 10, 11, 12, 13, 14, 15, 16, 17, 18, 19, 20, 21, 22, 23, 24, 27
- » 1/2" Deep Socket 12 pt Metric
- » 13, 14, 15, 16, 17, 18, 19, 24
- » Step Up Adaptor 3/8"F - 1/2"M

T1234	5557 g	£315.00



6-point sockets v 12-point sockets

12-point sockets, common in Aircraft Maintenance and Engineering, are ideal for use in confined space and for fast lightweight work. 6-point sockets are ideal for when extra torque needs to be applied. They are designed to contact the head of a fastener well away from the corners, this dramatically reduces the likelihood of slippage and rounding over of the corners.



SOCKET SETS



MECCA PRO 1/2" SOCKET & TOOL SET MM/AF 44 PIECES



- » 1/2" Ratchet FRP 45 Teeth
- » 1/2" Breaker Bar 450 mm DIN3122
- » Double Ring Spanner Rigger Jigger 10 x 13 mm
- » 1/2" Extension Bar 63.5 mm
- » 1/2" Extension Bar 125 mm
- » 1/2" Extension Bar 255 mm
- » 1/2" Universal Joint
- » 1/2" Spark Plug Socket
- » 16, 21
- » 1/2" Socket 12 pt AF
- » 3/8, 1/2, 9/16, 19/32, 11/16, 25/32, 13/16, 1
- » 1/2" Socket 12 pt Metric
- » 10, 11, 12, 13, 14, 15, 16, 17, 18, 19, 20, 21, 22, 23, 24, 27, 30, 32
- » 1/2" Deep Socket 12 pt Metric
- » 10, 13, 17, 19
- » Step Up Adaptor 3/8" F - 1/2" M
- » Flat Screwdriver
- » 1.0x5.5, 1.2x6.5
- » PZ Screwdriver
- » PZ1, PZ2



T1244

7368 g

£391.00



MECCA PRO 1/2" SOCKET & TOOL SET 68 PIECES



- » 1/2" Ratchet FRP 45 Teeth
- » Combination Spanner Metric
- » 8, 10, 11, 12, 13, 14, 15, 16, 17, 19
- » 1/4" Flat Bits 25 mm
- » 0.8x4.0, 0.8x5.5, 1.4x7.0
- » 1/4" Hex Bits 25 mm
- » 3, 4, 5, 6, 8, 10
- » 1/2" Extension Bar 63.5 mm
- » 1/2" Extension Bar 150 mm
- » 1/2" Universal Joint
- » 1/2" Socket 12 pt Metric
- » 10, 11, 12, 13, 14, 15, 16, 17, 18, 19, 21, 22, 24, 27, 30, 32
- » Step Up Adaptor 3/8" F - 1/2" M
- » Side Cutting Plier 160 mm
- » Heavy Duty Combination Plier 185 mm
- » Long Nose Plier 200 mm
- » Water Pump Plier 240 mm
- » Flat Screwdriver
- » 0.5x3.0, 1.0x5.5, 1.2x6.5
- » PH Screwdriver
- » PH0, PH1, PH2
- » 1/4" PH Bits 25 mm
- » PH0, PH1, PH2, PH3
- » 1/4" PZ Bits 25 mm
- » PZ1, PZ2, PZ3
- » 1/4" TX Bits 25 mm
- » TX8, TX10, TX15, TX20, TX25, TX27, TX30, TX40, TX45, TX50



T1268

6648 g

£509.00



1/2" SOCKET CLIP RAIL SET 12 PT 15 PIECES



» 10, 12, 13, 14, 15, 16, 17, 18, 19, 21, 22, 24, 27, 30, 32		
M1215MM	1364 g	£86.20



1/2" DEEP SOCKET CLIP RAIL SET 12 PT 8 PIECES



» 13, 14, 15, 17, 19, 21, 22, 24		
M1207	1330 g	£78.10



1/2" SOCKET CLIP RAIL SET 12 PT AF 15 PIECES



» 3/8, 7/16, 1/2, 9/16, 5/8, 11/16, 3/4, 13/16, 7/8, 15/16, 1, 1 1/16, 1 1/8, 1 3/16, 1 1/4		
M1215AF	1522 g	£86.90



1/2" DEEP SOCKET CLIP RAIL SET 6 PT 8 PIECES



» 13, 14, 15, 16, 17, 18, 19, 24		
M1208-6	1250 g	£81.20



SOCKET SETS



1/2" HEX BIT SOCKET CLIP RAIL SET 9 PIECES



» 5, 6, 7, 8, 9, 10, 12, 14, 17



M1212

726 g

£64.90



1/2" LONG HEX BIT SOCKET CLIP RAIL SET 6 PIECES



» 5, 6, 7, 8, 10, 12



M1211

550 g

£55.90



1/2" HEX BIT SOCKET CLIP RAIL SET AF 9 PIECES



» 3/16, 7/32, 1/4, 9/32, 5/16, 3/8, 1/2, 9/16, 5/8



M1209AF

634 g

£68.30



1/2" TX-E SOCKET CLIP RAIL SET 9 PIECES

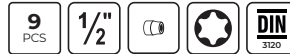

» E10, E11, E12, E14, E16, E18, E20, E22, E24



M1210

690 g

£63.40



1/2" TPX BIT SOCKET CLIP RAIL SET 9 PIECES



- » TPX20, TPX25, TPX27, TPX30, TPX40, TPX45, TPX50, TPX55, TPX60

M1213TPX	580 g	£65.90



1/2" TX BIT SOCKET CLIP RAIL SET 9 PIECES

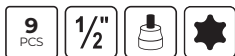

- » TX20, TX25, TX27, TX30, TX40, TX45, TX50, TX55, TX60

M1213TX	580 g	£66.20



MECCA PRO 3/4" SOCKET SET 6 PT 18 PIECES



- » 3/4" Ratchet Heavy Duty 72 Teeth
- » 3/4" Extension Bar 200 mm
- » 3/4" Extension Bar 400 mm
- » 3/4" Sliding T Bar
- » 3/4" Socket 6 pt Metric
- » 19, 21, 22, 24, 27, 30, 32, 33, 34, 36, 38, 41, 46, 50

T3418-6	14548 g	£615.00



1" SOCKET SET 12 PT 15 PIECES



- » 1" Ratchet Head 24 Teeth
- » 1" Power Bar 560 mm
- » T Bar Adaptor 1"
- » 1" Extension Bar 200 mm
- » 1" Extension Bar 400 mm
- » 1" Socket 12 pt Metric
- » 36, 41, 46, 50, 55, 60, 65, 70, 75, 80

M1115MM	25460 g	£989.00



SOCKET SETS

MECCA PRO 1/4" & 1/2" SOCKET & TOOL SET 95 PIECES

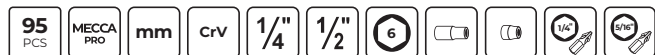

- » 1/2" Ratchet FRP 45 Teeth
- » 1/4" Ratchet FRP 45 Teeth
- » Hex Key Metric
- » 1.5, 2, 2.5
- » Combination Spanner Metric
- » 8, 10, 12, 13, 14, 17
- » 1/4" Magnetic Bit Holder 50 mm
- » 1/4" Flat Bits 25 mm
- » 0.8×4.0, 0.8×5.5, 1.4×7.0
- » 1/4" Hex Bits 25 mm
- » 3, 4, 5, 6, 8, 10
- » 1/2" Extension Bar 125 mm
- » 1/2" Extension Bar 255 mm
- » 1/2" Universal Joint
- » 1/2" Spark Plug Socket 21 mm
- » 1/2" Bit Adaptor 5/16" Hex
- » 1/2" Socket 6 pt Metric
- » 10, 11, 12, 13, 14, 15, 17, 19, 22, 24, 27, 30, 32
- » 1/4" Spinner Handle
- » 1/4" Extension Bar 50 mm
- » 1/4" Extension Bar 100 mm
- » 1/4" Universal Joint
- » Hex Socket Adaptor 1/4" Hex - 1/4" 25 mm
- » 1/4" Sliding T Bar
- » 1/4" Bit Adaptor Hex Bit Coupler
- » 1/4" Socket 6 pt Metric
- » 4, 4.5, 5, 5.5, 6, 7, 8, 9, 10, 11, 12, 13
- » 1/4" Deep Socket 6 pt Metric
- » 4, 5, 6, 7, 8, 9, 10, 11, 12, 13
- » Step Up Adaptor 3/8" F - 1/2" M
- » Flat Screwdriver
- » 0.5×3.0, 0.8×4.0
- » PH Screwdriver
- » PH1, PH2
- » PZ Screwdriver
- » PZ1, PZ2
- » 1/4" PH Bits 25 mm
- » PH0, PH1, PH2, PH3 (×2)
- » 1/4" PZ Bits 25 mm
- » PZ0, PZ1, PZ2, PZ3
- » 1/4" TX Bits 25 mm
- » TX8, TX10, TX15, TX20, TX25, TX27, TX30, TX40
- » 5/16" TX Bits 25 mm
- » TX45, TX55, TX50



TM095

6543 g

£411.00

MECCA PRO 1/4", 3/8" & 1/2" SOCKET SET 106 PIECES

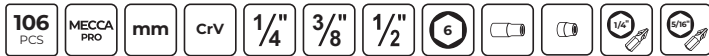

☰

- » 1/4" Ratchet FRP 45 Teeth
- » 3/8" Ratchet FRP 45 Teeth
- » Adjustable Wrench TPR Grip 250 mm
- » Spanner Ring
- » Combination Spanner Metric
 - » 8, 9, 10, 11, 12, 13, 14, 15, 16, 17, 18, 19
- » Double Flex Wrench Metric
 - » 8×9, 10×11, 12×13, 14×15
- » Bi-flex Wrench 1/4" Hex × 1/4"
- » 1/4" Flat Bits 25 mm
 - » 0,8×4,0, 0,8×5,5, 1,4×7,0
- » 1/4" Hex Bits 25 mm
 - » 3, 4, 5, 6, 8, 10
- » 1/2" Extension Bar 63.5 mm
- » 1/2" Extension Bar 255 mm
- » Reducing Adaptor 1/2"F - 3/8"M
- » 1/2" Flex Head Adaptor
- » 1/2" Socket 12 pt Metric
 - » 19, 24, 27, 30, 32
- » 1/4" Extension Bar 50 mm
- » 1/4" Extension Bar 75 mm
- » 1/4" Universal Joint
- » 1/4" Bit Adaptor Hex Bit Coupler
- » 1/4" Socket 6 pt Metric
 - » 4, 5, 5,5, 6, 7, 8, 10, 11, 12, 13
- » 1/4" Deep Socket 6 pt Metric
 - » 6, 7, 8, 10, 12, 13
- » 3/8" Extension Bar 75 mm
- » 3/8" Extension Bar 150 mm
- » 3/8" Universal Joint
- » 3/8" Drive Adaptor 3/8"F:1/4"M with 1/4" hole
- » Step Up Adaptor 3/8"F - 1/2"M
- » 3/8" Spark Plug Socket
 - » 16, 21
- » 3/8" Bit Adaptor Hex bit coupler 1/4" Hex
- » 3/8" Socket 6 pt Metric
 - » 8, 9, 10, 11, 12, 13, 14, 15, 16, 17, 18, 19, 21, 22
- » 1/4" PH Bits 25 mm
 - » PH0, PH1, PH2, PH3
- » 1/4" PZ Bits 25 mm
 - » PZ1, PZ2, PZ3
- » 1/4" XZN/Triple Square Bits 25 mm
 - » 5, 6
- » 1/4" TPX Bits 25 mm
 - » TPX10, TPX15, TPX20, TPX25, TPX27, TPX30, TPX40
- » 1/4" TX Bits 25 mm
 - » TX8, TX10, TX15, TX20, TX25, TX27, TX30, TX40



TM106



7753 g

£599.00



SOCKET SETS

MECCA PRO 1/4", 3/8" & 1/2" SOCKET SET MM/AF 111 PIECES

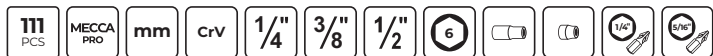

- » 1/2" Ratchet FRP 45 Teeth
- » 1/4" Ratchet FRP 45 Teeth
- » 3/8" Ratchet FRP 45 Teeth
- » 1/4" Flat Bits 25 mm
 - 0,8×4,0, 0,8×5,5, 1,4×7,0
- » 1/4" Hex Bits 25 mm
 - 3, 4, 5, 6, 7, 10
- » 1/4" Hex Bits 25 mm AF
 - 1/8, 9/64, 5/32, 3/16, 1/4
- » 1/4" Hex Bits 25 mm AF Hex 5/16"
- » 1/2" Extension Bar 63.5 mm
- » 1/2" Extension Bar 255 mm
- » Reducing Adaptor 1/2"F - 3/8"M
- » 1/2" Bit Adaptor 5/16" Hex
- » 1/2" Socket 12 pt AF
 - 11/16, 3/4, 13/16, 7/8, 1, 1 3/16
- » 1/2" Socket 6 pt Metric
 - 17, 24, 27, 32
- » 1/4" Spinner Handle
- » 1/4" Extension Bar 50 mm
- » 1/4" Extension Bar 100 mm
- » 1/4" Universal Joint
- » Step Up Adaptor 1/4"F - 3/8"M
- » 1/4" Extension Bar Flexible 150 mm
- » 1/4" Sliding T Bar
- » 1/4" Bit Adaptor Hex Bit Coupler
- » 1/4" Socket 6 pt AF
 - 3/16, 7/32, 1/4, 9/32, 3/8, 7/16
- » 1/4" Socket 6 pt Metric
 - 4, 5, 6, 7, 8, 10, 12
- » 3/8" Spinner Handle
- » 3/8" Extension Bar 75 mm
- » 3/8" Extension Bar 150 mm
- » 3/8" Universal Joint
- » Step Up Adaptor 3/8"F - 1/2"M
- » 3/8" Spark Plug Socket
 - 16, 21
- » 3/8" Bit Adaptor Hex bit coupler 1/4" Hex
- » 3/8" Socket 6 pt AF
 - 3/8, 7/16, 1/2, 9/16, 11/16, 3/4, 13/16, 7/8
- » 3/8" Deep Socket 6 pt AF
 - 3/8, 7/16, 1/2, 9/16, 11/16, 3/4, 13/16, 7/8
- » 3/8" Socket 6 pt Metric
 - 8, 9, 10, 12, 13, 14, 15, 16, 17
- » 3/8" Deep Socket 6 pt Metric
 - 8, 9, 10, 12, 13, 14, 15, 16, 17
- » 1/4" PH Bits 25 mm
 - PH1, PH2, PH3
- » 1/4" PZ Bits 25 mm
 - PZ1, PZ2, PZ3
- » 1/4" TX Bits 25 mm
 - TX10, TX15, TX20, TX25, TX30, TX40
- » 5/16" TX Bits 25 mm
 - TX45, TX50



TM111



9540 g

£591.00

MECCA PRO 1/4", 3/8" & 1/2" SOCKET & TOOL SET MM/AF 127 PIECES



☰

- » 1/4" Ratchet FRP 45 Teeth
- » 3/8" Ratchet FRP 45 Teeth
- » Adjustable Wrench Wide Jaw 250 mm
- » Spanner Ring
- » Combination Spanner Metric
 - » 8, 9, 10, 11, 12, 13, 14, 15, 16, 17, 18, 19
- » 1/4" Flat Bits 25 mm
 - » 0.8x4.0, 0.8x5.5, 1.4x7.0 (x2)
- » 1/4" Hex Bits 25 mm
 - » 3, 4, 5, 6, 8, 10
- » 1/4" Hex Bits 25 mm AF
 - » 1/8, 9/64, 5/32, 3/16, 1/4, 3/8
- » 1/2" Extension Bar 63.5 mm
- » 1/2" Extension Bar 255 mm
- » Reducing Adaptor 1/2" F - 3/8" M
- » 1/2" Flex Head Adaptor
- » 1/2" Socket 12 pt Metric
 - » 19, 24, 27, 30, 32
- » 1/4" Extension Bar 50 mm
- » 1/4" Extension Bar 75 mm
- » 1/4" Universal Joint
- » Hex Socket Adaptor 1/4" Hex - 1/4" 25 mm
- » 1/4" Bit Adaptor Hex Bit Coupler
- » 1/4" Socket 6 pt AF
 - » 3/16, 7/32, 1/4, 9/32, 5/16, 11/32, 3/8, 7/16, 1/2
- » 1/4" Socket 6 pt Metric
 - » 4, 5, 5.5, 6, 7, 8, 10, 11, 12, 13
- » 1/4" Deep Socket 6 pt Metric
 - » 6, 7, 8, 10, 12, 13
- » 3/8" Extension Bar 75 mm
- » 3/8" Extension Bar 150 mm
- » 3/8" Universal Joint
- » 3/8" Drive Adaptor 3/8" F:1/4" M with 1/4" hole
- » Step Up Adaptor 3/8" F - 1/2" M
- » 3/8" Spark Plug Socket
 - » 16, 21
- » 3/8" Bit Adaptor Hex bit coupler 1/4" Hex
- » 3/8" Socket 6 pt AF
 - » 5/16, 3/8, 7/16, 1/2, 9/16, 5/8, 11/16, 3/4, 13/16, 7/8
- » 3/8" Socket 6 pt Metric
 - » 8, 9, 10, 11, 12, 13, 14, 15, 16, 17, 18, 19, 21, 22
- » 1/4" Ratcheting Bits Driver Set
 - » 1/4" Flat Bits 25 mm
 - » 1.0x5.5, 1.4x7.0
 - » Hex Socket Adaptor 1/4" Hex - 1/4" 25 mm
 - » 1/4" PH Bits 25 mm
 - » PH1, PH2
 - » 1/4" PZ Bits 25 mm
 - » PZ1, PZ2
 - » 1/4" PH Bits 25 mm
 - » PH0, PH1 (x2), PH2 (x2), PH3
 - » 1/4" PZ Bits 25 mm
 - » PZ1 (x2), PZ2 (x2), PZ3
 - » 1/4" XZN/Triple Square Bits 25 mm
 - » 5, 6
 - » 1/4" TX Bits 25 mm
 - » TX8, TX10, TX15, TX20, TX25, TX30, TX40



TM127



7327 g

£469.00



SOCKET SETS

MECCA PRO 3/8" SOCKET & TOOL SET 80 PIECES



- » Folding Hex Key Set 1.5-6 mm ALU 7 Pieces
- » 3/8" Ratchet FRP 45 Teeth
- » Adjustable Wrench Wide Jaw 200 mm
- » Telescopic Magnetic Pick Up Tool
- » LED Torch With Pocket Clip
- » Combination Spanner Metric
- » 6, 7, 8, 10, 11
- » Double Ring Spanner Rigger Jigger 10 x 13 mm
- » Folding Utility Saw
- » Utility Knife
- » 1/4" Flat Bits 25 mm
- » 0.6x4.5, 0.8x5.5, 1.2x6.5
- » 1/4" PH G Bits 25 mm PH2G
- » 1/4" Hex Bits 25 mm
- » 3, 4, 5, 6
- » Carpenters Claw Hammer 16oz
- » Reducing Adaptor 1/2" F - 3/8" M
- » 3/8" Extension Bar 125 mm
- » 3/8" Universal Joint
- » 3/8" Bit Adaptor Hex bit coupler 1/4" Hex
- » 3/8" Socket 6 pt Metric
- » 8, 10, 11, 12, 13, 14, 15, 17, 19, 20, 21, 22
- » Side Cutting Plier 160 mm
- » Combination Plier 180 mm
- » Long Nose Plier 165 mm
- » Water Pump Plier 180 mm
- » 1/4" Magnetic Bits Driver 217 mm
- » Flat Screwdriver
- » 0.5x3.0, 1.0x5.5
- » PH Screwdriver
- » PH1, PH2
- » Measuring Tape Metric 5m
- » 1/4" PH Bits 25 mm
- » PH1, PH2, PH3
- » 1/4" PZ Bits 25 mm
- » PZ1, PZ2, PZ3
- » 1/4" ROB Bits 25 mm
- » 1, 2, 3
- » Hook & Pick Set With Belt Clip 4 Pieces
- » 1/4" TPX Bits 25 mm
- » TPX20, TPX25, TPX30
- » 1/4" TX Bits 25 mm
- » TX10, TX15, TX20, TX25, TX27, TX30, TX40



TM080



5956 g

£630.90



1/2" XZN/TRIPLE SQUARE IMPACT SOCKET SET DIN 6 PIECES



☰		
»	14 (x2), 16 (x2), 18 (x2)	
T9206	881 g	£82.90



MECCA PRO 1/2" DEEP IMPACT SOCKET SET DIN AF 18 PIECES

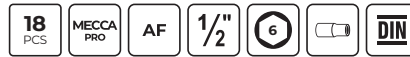

☰		
»	1/2" Deep Impact Socket DIN AF	
»	3/8, 7/16, 1/2, 9/16, 5/8, 11/16, 3/4, 13/16, 7/8, 15/16, 1, 1 1/16, 1 1/8, 1 1/4	
»	Retaining Ring	
»	19x4, 24x4	
»	Retaining Pin	
»	3x20, 3x25	
T9218LAF	4200 g	£265.90



MECCA PRO 1/2" IMPACT SOCKET SET DIN AF 18 PIECES

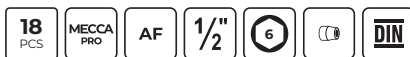

☰		
»	1/2" Impact Socket DIN AF	
»	3/8, 7/16, 1/2, 9/16, 5/8, 11/16, 3/4, 13/16, 7/8, 15/16, 1, 1 1/16, 1 1/8, 1 1/4	
»	Retaining Ring	
»	19x4, 24x4	
»	Retaining Pin	
»	3x20, 3x25	
T9218AF	2448 g	£183.90



MECCA PRO 1/2" IMPACT SOCKET SET DIN 22 PIECES



☰		
»	1/2" Impact Socket DIN Metric	
»	10, 11, 12, 13, 14, 15, 16, 17, 18, 19, 21, 22, 24, 27, 28, 29, 30, 32	
»	Retaining Ring	
»	19x4, 24x4	
»	Retaining Pin	
»	3x20, 3x25	
T9222	3456 g	£210.90



SOCKET SETS



MECCA PRO 1/2" DEEP IMPACT SOCKET SET DIN 22 PIECES



- » 1/2" Deep Impact Socket DIN Metric
- » 10, 11, 12, 13, 14, 15, 16, 17, 18, 19, 21, 22, 24, 27, 28, 29, 30, 32
- » Retaining Ring
- » 19×4, 24×4
- » Retaining Pin
- » 3×20, 3×25



T9222L

6413 g

£346.90



MECCA PRO 1/2" IMPACT SOCKET SET DIN 40 PIECES



- » 1/2" Impact Socket DIN Metric
- » 10, 11, 12, 13, 14, 15, 16, 17, 18, 19, 21, 22, 24, 27, 28, 29, 30, 32
- » 1/2" Deep Impact Socket DIN Metric
- » 10, 11, 12, 13, 14, 15, 16, 17, 18, 19, 21, 22, 24, 27, 28, 29, 30, 32
- » Retaining Ring
- » 19×4, 24×4
- » Retaining Pin
- » 3×20, 3×25



T9240

10150 g

£540.90



DIN Standard sockets require a retaining ring and pin to safely secure the socket to the impact tool.



MECCA PRO 3/4" IMPACT SOCKET SET DIN 17 PIECES



- » 3/4" Impact Socket DIN Metric
- » 19, 21, 22, 23, 24, 27, 30, 32, 33, 34, 36, 38, 41, 46, 50
- » Retaining Ring 36 × 5.0 mm
- » Retaining Pin 4 × 35 mm



T9417

8660 g

£439.90



MECCA PRO 3/4" DEEP IMPACT SOCKET SET DIN 17 PIECES



- » 3/4" Deep Impact Socket DIN Metric
- » 19, 21, 22, 23, 24, 27, 30, 32, 33, 34, 36, 38, 41, 46, 50
- » Retaining Ring 36 × 5.0 mm
- » Retaining Pin 4 × 35 mm



T9417L 13995 g £639.90



MECCA PRO 3/4" DEEP IMPACT SOCKET SET DIN AF 21 PIECES



- » 3/4" Deep Impact Socket DIN AF
- » 3/4, 13/16, 7/8, 15/16, 1, 1 1/16, 1 1/8, 1 3/16, 1 1/4, 1 5/16, 1 3/8, 1 7/16, 1 1/2, 1 9/16, 1 5/8, 1 11/16, 1 3/4, 1 13/16, 1 7/8
- » Retaining Ring 36 × 5.0 mm
- » Retaining Pin 4 × 35 mm



T9421LAF 17400 g £754.90



MECCA PRO 3/4" IMPACT SOCKET SET DIN AF 23 PIECES

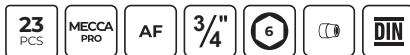

- » 3/4" Impact Socket DIN AF
- » 11/16, 3/4, 13/16, 7/8, 15/16, 1, 1 1/16, 1 1/8, 1 3/16, 1 1/4, 1 5/16, 1 3/8, 1 7/16, 1 1/2, 1 9/16, 1 5/8, 1 11/16, 1 3/4, 1 7/8, 1 15/16, 2
- » Retaining Ring 36 × 5.0 mm
- » Retaining Pin 4 × 35 mm



T9423AF 12860 g £608.90



3/8" DEEP IMPACT SOCKET CLIP RAIL SET ANSI 8 PIECES



- » 8, 10, 11, 13, 14, 16, 17, 19



9386 894 g £55.50

SOCKET SETS



1/2" IMPACT SOCKET CLIP RAIL SET ANSI 10 PIECES



☰		
»	10, 11, 12, 13, 14, 17, 19, 21, 22, 24	
9121	1008 g	£64.80



1/2" STUBBY IMPACT SOCKET CLIP RAIL SET DIN 12 PIECES



☰		
»	10, 12, 13, 14, 15, 16, 17, 18, 19, 21, 22, 24	
9207S12	832 g	£97.20



1/2" DEEP IMPACT SOCKET CLIP RAIL SET ANSI 10 PIECES



☰		
»	10, 11, 12, 13, 14, 17, 19, 21, 22, 24	
9126	2152 g	£99.90



1" IMPACT SOCKET SET DIN 27 - 50MM 13 PIECES

13 PCS
mm
1"
6
1
DIN
DIN 3129



- » 1" Impact Socket DIN Metric
- » 27, 30, 32, 36, 38, 41, 46, 50
- » Impact Step Up Adaptor 3/4"F - 1"M DIN
- » Retaining Ring
- » 36×5, 45×7
- » Retaining Pin
- » 4×35, 5×45



9113 9050 g £387.50



1" IMPACT SOCKET SET DIN 36 - 80MM 17 PIECES

17 PCS
mm
1"
6
1
DIN
DIN 3129



- » 1" Impact Socket DIN Metric
- » 36, 41, 46, 50, 55, 60, 65, 70, 75, 80
- » Impact Step Up Adaptor 3/4"F - 1"M DIN
- » Retaining Ring
- » 34×5, 45×7, 51×7
- » Retaining Pin
- » 4×35, 5×45, 5×51



9117 20900 g £943.40



SOCKETS & ACCESSORIES

GET THE JOB DONE, FAST

The socket range includes drives from ¼" to 1" and includes six-point sockets and twelve-point sockets, metric and imperial sizes as well as a wide range of bit sockets including Hex, TX, TX-E, and TPX.

FRP RATCHETS

Quick release mechanism that makes it possible to release sockets and accessories with one hand

Ratchet mechanism with 45 teeth (8 degree intervals)

Lever for quick reversing between left and right-hand action

All individual parts and service kits are available and easy to fit

Fibre ratchet handle with steel reinforcement that is lighter than standard ratchet handles, but just as strong

Bi-material handle with an ergonomic design that makes the ratchet very comfortable to use, especially in cold environments



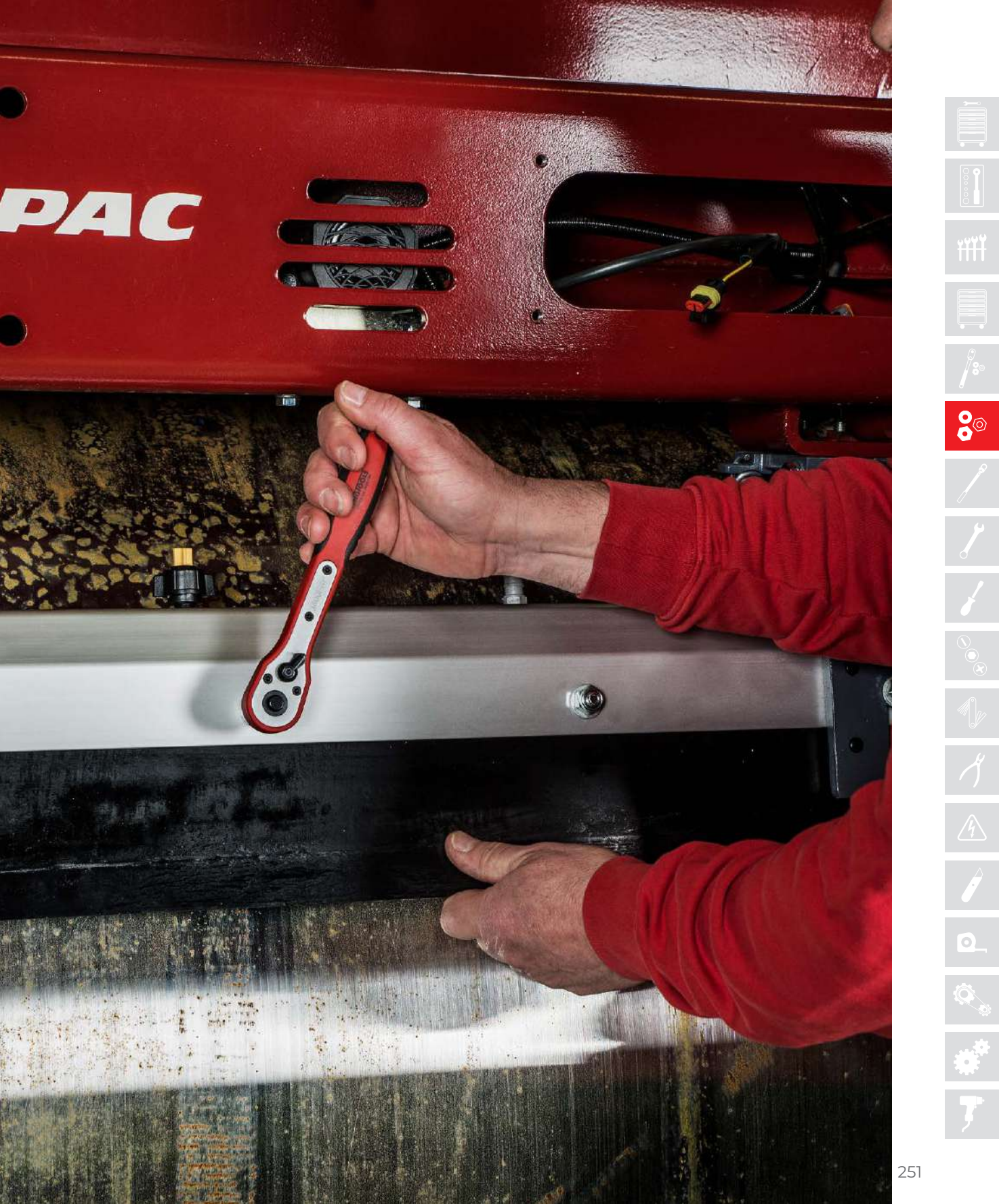

SOCKETS & ACCESSORIES

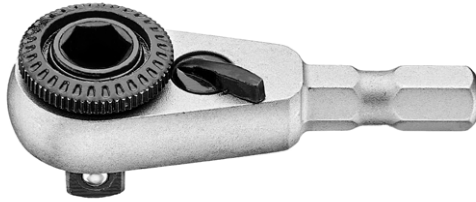

1/4" RATCHET HEAD HEX/SQUARE DRIVE



RHA14	Ratchet	1/4"	1/4" Hex	35 g £20.80



1/4" MINI PALM RATCHET 45 TEETH



1400M	Quick Release	1/4"	Twist	76 (mm)	76 g	£38.50



1/4" GEARLESS PALM RATCHET



PM14	Gearless	1/4"	Twist	81 g	£18.00



1/4" MINI RATCHET 72 TEETH



1400-72MN	Twist	1/4"	Twist	121 (mm)	82 g	£51.50



RATCHET 72 TEETH



1400-72N	1/4"	Twist	150	112 g	£57.90	



RATCHET 72 TEETH FLEXIBLE HEAD

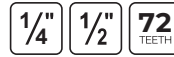

1400-72SN	1/4"	Twist	121	107 g	£62.10	
1200-72SN	Quick Release	1/2"	Twist	190	384 g	£81.20



RATCHET 72 TEETH IP5X



3800-72MN	Quick Release	3/8"	Flip reverse lever	110	201 g	£59.10
1400-72U	Quick Release	1/4"	Flip reverse lever	142	100 g	£64.20
3800-72U	Quick Release	3/8"	Flip reverse lever	195	250 g	£72.40
1200-72U	Quick Release	1/2"	Flip reverse lever	250	440 g	£82.60



RATCHET FRP 45 TEETH

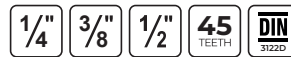

1400FRP	Quick Release	1/4"	Flip reverse lever	150	99 g	£40.50
3800FRP	Quick Release	3/8"	Flip reverse lever	203	235 g	£51.90
1200FRP	Quick Release	1/2"	Flip reverse lever	250	511 g	£66.50



SOCKETS & ACCESSORIES



LONG RATCHET FLEXIBLE HEAD

1/4" 3/8" 1/2"

Model	Teeth	Release	Size	Twist	Length (mm)	Weight (g)	Price (£)
1400F	43	Quick Release	1/4"	Twist	200	174 g	£50.90
3800F	41	Quick Release	3/8"	Twist	300	421 g	£61.60
1200F	45		1/2"	Twist	400	832 g	£65.00



RATCHET HEAVY DUTY

3/4" 1" 72 TEETH

Model	Release	Size	Twist	Length (mm)	Weight (g)	Price (£)
M3400-72	Quick Release	3/4"	Twist	505	2000 g	£195.90
M1100-72	Quick Release	1"	Twist	800	4060 g	£326.90



RATCHET LONG ARM

1/4" 3/8" 1/2"

Model	Teeth	Release	Size	Twist	Length (mm)	Weight (g)	Price (£)
1400L	43	Quick Release	1/4"	Twist	200	161 g	£41.70
3800L	41	Quick Release	3/8"	Twist	300	392 g	£52.30
1200L	45		1/2"	Twist	400	773 g	£63.20



EXTENDABLE RATCHET

3/8" 1/2" 3/4"

Model	Release	Size	Twist	Length (mm)	Weight (g)	Price (£)
3800-41E	Quick Release	3/8"	Push twist	250 - 356	465 g	£63.60
1200-45E	Quick Release	1/2"	Push twist	356 - 508	989 g	£87.30
M340072E	Quick Release	3/4"	Twist	545-860	3372 g	£267.90



1" RATCHET 24 TEETH



M1100 Quick Release 1" Flip reverse lever 665 4410 g £219.00



1" POWER BAR 560MM



M110020 1" Metal 560 2670 g £61.90



1" RATCHET HEAD



M110010 Quick Release 1" Flip reverse lever 165 1740 g £172.90

RATCHET REPAIR KITS



1400-72NRK	Repair Kit 72 Teeth Ratchet 1400-72N	£28.50
1400-72URK	Repair Kit 72 Teeth Ratchet 1400-72U	£16.20
1400FRK	Repair Kit for 1400F & 1400L	£16.20
1400FRPRK	Repair Kit FRP Ratchet 1400FRP	£19.00
3800-41ERK	Repair Kit 3800-41E	£18.30
3800-72NRK	Repair Kit 72 Teeth Ratchet 3800-72N	£29.50
3800-72URK	Repair Kit 72 Teeth Ratchet 3800-72U/72MN	£20.30
3800FRK	Repair Kit for 3800F & 3800L	£18.50
3800FRPRK	Repair Kit FRP Ratchet 3800FRP	£22.30
1200-72NRK	Repair Kit 72 Teeth Ratchet 1200-72N	£37.00
1200-72URK	Repair Kit 72 Teeth Ratchet 1200-72U	£22.30
1200FRK	Repair Kit for 1200F, 1200L & 1200-45E	£28.40
1200FRPRK	Repair Kit FRP Ratchet 1200FRP	£27.30
M3400-72RK	Repair Kit M3400-72 & M340072E	£85.60
M1100-72RK	Repair Kit M110072	£99.30
M1100RK	Repair Kit M1100	£78.90

SOCKETS & ACCESSORIES



SPINNER HANDLE



Part No.	Drive Size	Material	Length (mm)	Weight (g)	Price
M140015-C	1/4"	Bi-material	150	97 g	£16.70
M380015-C	3/8"	Bi-material	250	279 g	£25.00



3/8" ROTATING SPINNER HANDLE



Part No.	Drive Size	Material	Length (mm)	Weight (g)	Price
PT3810R	3/8"	Bi-material	250	303 g	£26.20



1/4" EXTRA LONG FLEXIBLE SOCKET DRIVER 555MM



Part No.	Drive Size	Material	Flexibility	Length (mm)	Weight (g)	Price
MDS14L	1/4"	Bi-material	Yes	555	244 g	£25.40



SPINNER HANDLES with female intake in 1/4" & 3/8" drive are available. The handle can be used with a ratchet as an extension bar





FLEX HANDLE



M140012-C	1/4"	Bi-material		200	118 g	£44.80
M380010A-C	3/8"	Bi-material		250	300 g	£32.90
M380012-C	3/8"	Bi-material		300	306 g	£46.80
M120010-C	1/2"	Bi-material		265	492 g	£38.70
M120012-C	1/2"	Bi-material		410	630 g	£66.20
M340070-C	3/4"	Metal		480	1902 g	£90.40
M340070S-C	3/4"		Yes	480	1880 g	£99.90
M110070	1"			650	3550 g	£196.90

FLEX HANDLE & BREAKER BAR REPAIR KITS

M140012RK	Repair Kit for M140012-C	£11.00
M380012RK	Repair Kit for M380012-C	£12.10
1201ARK	Repair Kit for 1201 & 1201A	£23.20
M120010RK	Repair Kit M120010	£16.50
M340070RK	Repair Kit M340070	£24.40
M340070SRK	Repair Kit M340070S	£32.80
M110070RK	Repair Kit M110070	£62.00



BREAKER BAR DIN3122



1201	1/2"	Bi-material	450	823 g	£51.90
1201A	1/2"	Bi-material	600	1186 g	£80.50
3401	3/4"	Metal	990	3730 g	£219.90
1101	1"		990	3810 g	£242.90



SPEED BRACE



M120011-C	1/2"	420	585 g	£37.20
M380011-C	3/8"	380	310 g	£25.20



SOCKETS & ACCESSORIES



EXTENSION BAR

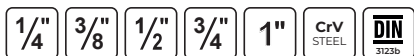

			(mm)	(AF)			
M140020-C		1/4"	50	50		21 g	£5.60
M140021-C		1/4"	100	100		42 g	£6.50
M140022-C		1/4"	150	150		64 g	£7.00
M140023-C		1/4"	75	75		31 g	£6.40
M140024-C		1/4"	305	305		130 g	£16.50
M140038-C		1/4"	150	150		26 g	£15.60
M380020-C		3/8"	75	75		69 g	£7.40
M380021-C		3/8"	150	150		143 g	£9.30
M380022-C		3/8"	254	254		242 g	£13.20
M380023-C		3/8"	125	125		113 g	£9.00
M380024-C		3/8"	500	500		505 g	£33.10
M120020-C		1/2"	63.5	63.5		105 g	£9.50
M120021-C		1/2"	125	125		222 g	£12.20
M120022-C		1/2"	255	255		420 g	£18.90
M120023-C		1/2"	150	150		240 g	£11.50
M120024-C		1/2"	500	500		855 g	£39.90
M340020-C		3/4"	100	100		400 g	£22.10
M340020S-C		3/4"	100	100	Yes	450 g	£35.50
M340021-C		3/4"	200	200		750 g	£32.50
M340021S-C		3/4"	200	200	Yes	800 g	£41.00
M340022-C		3/4"	400	400		1400 g	£46.10
M340022S-C		3/4"	400	400	Yes	1450 g	£60.10
M110040		1"	200	200		2700 g	£70.50
M110050		1"	400	400		2480 g	£91.60



WOBBLE EXTENSION BAR

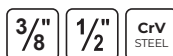

			(mm)	(AF)	
M380020W-C		3/8"	75	75	£12.00
M380021W-C		3/8"	150	150	£15.00
M380022W-C		3/8"	255	255	£19.10
M120020W-C		1/2"	75	75	£15.10
M120021W-C		1/2"	150	150	£19.20
M120022W-C		1/2"	255	255	£24.20



UNIVERSAL JOINT

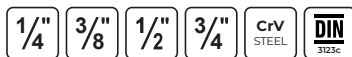

			(mm)	
M140030-C		1/4"	33	£16.70
M380030-C		3/8"	50	£19.70
M120030-C		1/2"	69	£23.90
M340030-C		3/4"	108	£63.60



1/4" MAGNETIC PICK UP SOCKET



M140060M



1/4"

£9.10



ADAPTORS

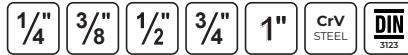

M140036-C

Step-up



1/4"



3/8"



(mm)

25

£5.60

M140037

Hex coupler

1/4"

1/4"

25

£6.10

M140039

Hex coupler

1/4"

1/4"

30

£5.50

M380035-C

Reducing

3/8"

1/4"

Yes (3/8")

25.4

£9.70

M380035A-C

Reducing

3/8"

1/4"

Yes (1/4")

25.4

£9.70

M380036-C

Step-up

3/8"

1/2"

Yes

36

£10.20

M380037

Hex coupler

1/4"

3/8"

32

£10.00

M120036-C

Reducing

1/2"

3/8"

Yes

39.5

£9.40

M120037-C

Step-up

1/2"

3/4"

39.5

£19.00

M340085-C

Step-up

3/4"

1"

62

£28.70

M340086-C

Reducing

3/4"

1/2"

40

£25.00

M110030

T-Bar

1"

1"

Yes

82

£44.70



1/2" FLEX HEAD ADAPTOR



M120080-C



Flex head

1/2"

£24.00

SOCKETS & ACCESSORIES



HEX BIT COUPLER



		1	2	(mm)	
M140060-C	Hex bit coupler	1/4"	1/4" Hex	25	£6.40
M380060-C	Hex bit coupler	3/8"	1/4" Hex	28	£7.40
M380061-C	Hex bit coupler	3/8"	10mm	28	£9.40
M120060-C	Hex bit coupler	1/2"	5/16" Hex	38	£10.00
M120061-C	Hex bit coupler	1/2"	10mm	38	£12.90
M120062-C	Hex bit coupler	1/2"	12mm	38	£14.90
M120063-C	Hex bit coupler	1/2"	1/4" Hex	25	£14.90



INSERT STEP UP ADAPTOR

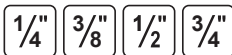

		1	2	(mm)	
M140036M	Step-up	1/4"	3/8"	28	£16.20
M380036M	Step-up	3/8"	1/2"	30	£24.40
M120037M	Step-up	1/2"	3/4"	45	£32.10
M340085M	Step-up	3/4"	1"	54	£37.50



STEP UP ADAPTOR SET 4 PIECES

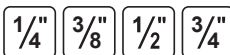

»	Insert Step Up Adaptor 1/2" F - 3/4" M
»	Insert Step Up Adaptor 1/4" F - 3/8" M
»	Insert Step Up Adaptor 3/4" F - 1" M
»	Insert Step Up Adaptor 3/8" F - 1/2" M



MX04 £101.90



SLIDING T BAR

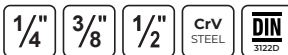

		1		(mm)	
M140050-C		1/4"		106	£8.00
M380050-C		3/8"	Yes	170	£19.00
M120050-C		1/2"		243	£20.20
M340050-C		3/4"		450	£54.40
M340050S-C		3/4"	Yes	450	£69.90



T-BAR HANDLE



T-HD	T Bar Handle Grip	£9.10
T-HD01	T Bar for T Bar Sockets	£8.00



1/4" SOCKET 6 PT METRIC



	(mm)	1 (mm)	2 (mm)			
M140504-C	4 mm	25	6.9	12	12 g	£5.00
M1405045-C	4.5 mm	25	7.5	12	12 g	£5.00
M140505-C	5 mm	25	8.1	12	13 g	£5.00
M1405055-C	5.5 mm	25	8.8	12	13 g	£5.00
M140506-C	6 mm	25	9.4	12	13 g	£5.00
M140507-C	7 mm	25	10.9	12	14 g	£5.00
M140508-C	8 mm	25	12	11.5	14 g	£5.00
M140509-C	9 mm	25	13.2	12	15 g	£5.00
M140510-C	10 mm	25	14.7	13	17 g	£5.00
M140511-C	11 mm	25	16	13	20 g	£5.00
M140512-C	12 mm	25	16.9	13.5	21 g	£5.00
M140513-C	13 mm	25	17.7	14	22 g	£5.20



1/4" SOCKET 12 PT METRIC



	(mm)	1 (mm)	2 (mm)			
M14050412-C	4 mm	25	6.9	12	12 g	£5.00
M14050512-C	5 mm	25	8.1	12	13 g	£5.00
M140505512-C	5.5 mm	25	8.8	12	13 g	£5.00
M14050612-C	6 mm	25	9.4	12	13 g	£5.00
M14050712-C	7 mm	25	10.9	12	14 g	£5.00
M14050812-C	8 mm	25	12	11.5	14 g	£5.00
M14050912-C	9 mm	25	13.2	12	15 g	£5.00
M14051012-C	10 mm	25	14.7	13	17 g	£5.00
M14051112-C	11 mm	25	16	13	20 g	£5.00
M14051212-C	12 mm	25	16.9	13.5	21 g	£5.00
M14051312-C	13 mm	25	17.7	14	22 g	£5.20



SOCKETS & ACCESSORIES



1/4" SOCKET 6 PT AF



		(mm)	1 (mm)	2 (mm)		
M140106-C	3/16 in	25	8	12	12 g	£5.20
M140107-C	7/32 in	25	8.8	12	12 g	£5.20
M140108-C	1/4 in	25	10	12	14 g	£5.20
M140109-C	9/32 in	25	12	10.9	14 g	£5.20
M140110-C	5/16 in	25	12	11.4	14 g	£5.20
M140111-C	11/32 in	25	13.2	11.9	16 g	£5.30
M140112-C	3/8 in	25	14.4	12.4	18 g	£5.30
M140114-C	7/16 in	25	16	12.9	20 g	£5.40
M140116-C	1/2 in	25	17.7	13.9	22 g	£5.40



1/4" SOCKET 12 PT AF



		(mm)	1 (mm)	2 (mm)		
M14010612-C	3/16 in	25	8	12	12 g	£5.20
M14010712-C	7/32 in	25	8.8	12	12 g	£5.20
M14010812-C	1/4 in	25	10	12	14 g	£5.20
M14010912-C	9/32 in	25	12	10.9	14 g	£5.20
M14011012-C	5/16 in	25	12	11.4	14 g	£5.20
M14011112-C	11/32 in	25	13.2	11.9	16 g	£5.30
M14011212-C	3/8 in	25	14.4	12.4	18 g	£5.30
M14011412-C	7/16 in	25	16	12.9	20 g	£5.40
M14011612-C	1/2 in	25	17.7	13.9	22 g	£5.40





1/4" DEEP SOCKET 6 PT METRIC



		(mm)	1 (mm)	2 (mm)		
M140604-C	4 mm	49.5	6.9	11.8	24 g	£7.50
M140605-C	5 mm	49.5	8	11.8	26 g	£7.50
M1406055-C	5.5 mm	49.5	8.8	11.8	26 g	£7.50
M140606-C	6 mm	49.5	9.4	11.8	26 g	£7.50
M140607-C	7 mm	49.5	10.9	11.8	21 g	£7.50
M140608-C	8 mm	49.5	11.8	11.8	22 g	£7.50
M140609-C	9 mm	49.5	12.8	12.8	33 g	£7.50
M140610-C	10 mm	49.5	14.5	14.5	36 g	£7.50
M140611-C	11 mm	49.5	15.6	15.6	46 g	£7.50
M140612-C	12 mm	49.5	16.6	16.6	45 g	£7.50
M140613-C	13 mm	49.5	17.6	17.6	50 g	£8.00



1/4" DEEP SOCKET 12 PT METRIC



		(mm)	1 (mm)	2 (mm)		
M14060612-C	6 mm	49.5	9.4	11.8	26 g	£7.50
M14060712-C	7 mm	49.5	10.9	11.8	27 g	£7.50
M14060812-C	8 mm	49.5	11.8	11.8	30 g	£7.50
M14060912-C	9 mm	49.5	12.8	12.8	33 g	£7.50
M14061012-C	10 mm	49.5	14.5	14.5	36 g	£7.50
M14061112-C	11 mm	49.5	15.6	15.6	46 g	£7.50
M14061212-C	12 mm	49.5	16.6	16.6	45 g	£7.50
M14061312-C	13 mm	49.5	17.6	17.6	50 g	£7.70



"Hip Grip"

All sockets are produced according to TengTools "hip grip" system, which means the socket grips on the flat surfaces of the nut rather than on the corner. This system helps to prevent damage to nuts and bolts and makes it possible to grip nuts and bolts which already have damaged corners.

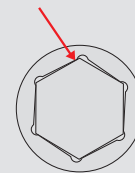

SOCKETS & ACCESSORIES



1/4" DEEP SOCKET 6 PT AF



		(mm)	1 (mm)	2 (mm)		
M140206-C	3/16 in	49.5	8	11.8	24 g	£7.90
M140207-C	7/32 in	49.5	9	11.8	26 g	£7.90
M140208-C	1/4 in	49.5	10	11.8	28 g	£7.90
M140209-C	9/32 in	49.5	11	11.8	28 g	£7.90
M140210-C	5/16 in	49.5	11.8	11.8	29 g	£7.90
M140211-C	11/32 in	49.5	12.8	12.8	34 g	£7.90
M140212-C	3/8 in	49.5	14.5	14.5	43 g	£7.90
M140214-C	7/16 in	49.5	15.6	15.6	46 g	£7.90
M140216-C	1/2 in	49.5	17.6	17.6	56 g	£8.10



1/4" DEEP SOCKET 12 PT AF



		(mm)	1 (mm)	2 (mm)		
M14020612-C	3/16 in	49.5	8	11.8	24 g	£7.90
M14020712-C	7/32 in	49.5	9	11.8	26 g	£7.90
M14020812-C	1/4 in	49.5	10	11.8	28 g	£7.90
M14020912-C	9/32 in	49.5	11	11.8	28 g	£7.90
M14021012-C	5/16 in	49.5	11.8	11.8	29 g	£7.90
M14021112-C	11/32 in	49.5	12.8	12.8	34 g	£7.90
M14021212-C	3/8 in	49.5	14.5	14.5	43 g	£7.90
M14021412-C	7/16 in	49.5	15.6	15.6	46 g	£7.90
M14021612-C	1/2 in	49.5	17.6	17.6	56 g	£8.00



1/4" FLAT BIT SOCKET



		(mm)	2 (mm)	1 (mm)		
M141404-C	4 mm	32	15	12	13 g	£5.00
M1414055-C	5.5 mm	32	15	12	13 g	£5.00
M141407-C	7 mm	32	15	12	14 g	£5.00



1/4" PH BIT SOCKET



		(mm)	2 (mm)	1 (mm)		
M141300-C	PH0	32	15	12	13 g	£5.00
M141301-C	PH1	32	15	12	13 g	£5.00
M141302-C	PH2	32	15	12	13 g	£5.00
M141303-C	PH3	32	15	12	13 g	£5.00



1/4" PZ BIT SOCKET



		1 (mm)	2 (mm)	(mm)		
M141601-C	PZ1	32	15	12	13 g	£5.00
M141602-C	PZ2	32	15	12	13 g	£5.00
M141603-C	PZ3	32	15	12	13 g	£5.00



1/4" TX BIT SOCKET



		1 (mm)	2 (mm)	(mm)		
M141210T-C		10	32	15	12	13 g £5.00
M141215T-C		15	32	15	12	13 g £5.00
M141220T-C		20	32	15	12	13 g £5.00
M141225T-C		25	32	15	12	13 g £5.00
M141227T-C		27	32	15	12	14 g £5.00
M141230T-C		30	32	15	12	14 g £5.00
M141240T-C		40	32	15	12	14 g £5.00



1/4" HEX BIT SOCKET METRIC



		1 (mm)	2 (mm)	(mm)		
M141503-C	3 mm	32	15	12	13 g	£7.00
M141504-C	4 mm	32	15	12	13 g	£7.00
M141505-C	5 mm	32	15	12	14 g	£7.00
M1415055-C	5.5 mm	32	15	12	14 g	£7.00
M141506-C	6 mm	32	15	12	14 g	£7.00
M141507-C	7 mm	32	15	12	15 g	£7.20
M141508-C	8 mm	32	15	12	16 g	£7.20
M141510-C	10 mm	32	15	12	18 g	£7.70
M141512-C	12 mm	32	15	12	22 g	£8.50



1/4" TX-E SOCKET



		(mm)	1 (mm)	2 (mm)		
M140704-C	E4	25	5.8	12	9 g	£5.30
M140705-C	E5	25	6.8	12	9 g	£5.30
M140706-C	E6	25	8	12	9 g	£5.30
M140707-C	E7	25	9.4	12	11 g	£5.30
M140708-C	E8	25	10.4	12	11 g	£5.30



SOCKETS & ACCESSORIES



3/8" SOCKET 6 PT METRIC



	(mm)	1 (mm)	2 (mm)			
M380507-C	7 mm	26	10.8	17.1	21 g	£5.40
M380508-C	8 mm	26	12	17.1	18 g	£5.70
M380509-C	9 mm	26	13.1	17.1	20 g	£5.70
M380510-C	10 mm	26	14.7	17.1	21 g	£5.70
M380511-C	11 mm	26	16	17.1	22 g	£5.70
M380512-C	12 mm	26	17.1	16.5	21 g	£5.70
M380513-C	13 mm	26	18.3	16.9	25 g	£5.70
M380514-C	14 mm	26	19.5	17.8	27 g	£5.80
M380515-C	15 mm	26	20.4	17.8	27 g	£5.80
M380516-C	16 mm	29	22.1	18.9	39 g	£6.80
M380517-C	17 mm	29	23.3	18.9	40 g	£6.90
M380518-C	18 mm	29	24.2	20	45 g	£7.00
M380519-C	19 mm	29	25.7	21	53 g	£7.00
M380520-C	20 mm	29	26.7	22	57 g	£7.60
M380521-C	21 mm	29	27.7	23	60 g	£8.10
M380522-C	22 mm	29	29.8	24	70 g	£8.10



3/8" SOCKET 12 PT METRIC



	(mm)	1 (mm)	2 (mm)			
M38050812-C	8 mm	26	12	17.1	18 g	£5.70
M38050912-C	9 mm	26	13.1	17.1	20 g	£5.70
M38051012-C	10 mm	26	14.7	17.1	21 g	£5.70
M38051112-C	11 mm	26	16	17.1	22 g	£5.70
M38051212-C	12 mm	26	17.1	16.5	21 g	£5.70
M38051312-C	13 mm	26	18.3	16.9	25 g	£5.70
M38051412-C	14 mm	26	19.5	17.8	27 g	£5.80
M38051512-C	15 mm	26	20.4	17.8	27 g	£5.80
M38051612-C	16 mm	29	22.1	18.9	39 g	£6.70
M38051712-C	17 mm	29	23.3	18.9	40 g	£6.90
M38051812-C	18 mm	29	24.2	20	45 g	£6.90
M38051912-C	19 mm	29	25.7	21	53 g	£7.00
M38052212-C	22 mm	29	29.8	24	70 g	£8.10



3/8" SOCKET 6 PT AF



		(mm)	1 (mm)	2 (mm)		
M380110-C	5/16 in	26	11.7	17.1	23 g	£5.80
M380112-C	3/8 in	26	14.2	17.1	24 g	£5.80
M380114-C	7/16 in	26	16.3	17.1	26 g	£5.90
M380116-C	1/2 in	26	18.3	16.9	34 g	£5.90
M380118-C	9/16 in	26	19.5	17.8	38 g	£5.90
M380120-C	5/8 in	29	22.1	18.9	46 g	£5.90
M380122-C	11/16 in	29	24.2	20	50 g	£6.90
M380124-C	3/4 in	29	25.7	21	60 g	£7.30
M380126-C	13/16 in	29	27.7	23	68 g	£7.40
M380128-C	7/8 in	29	29.5	24	75 g	£7.60



3/8" SOCKET 12 PT AF



		(mm)	1 (mm)	2 (mm)		
M38011212-C	3/8 in	26	14.2	17.1	24 g	£5.80
M38011412-C	7/16 in	26	16.3	17.1	26 g	£5.80
M38011612-C	1/2 in	26	18.3	16.9	34 g	£5.90
M38011812-C	9/16 in	26	19.5	17.8	38 g	£5.90
M38012012-C	5/8 in	29	22.1	18.9	46 g	£5.90
M38012212-C	11/16 in	29	24.2	20	50 g	£6.80
M38012412-C	3/4 in	29	25.7	21	60 g	£7.10



6-point sockets v 12-point sockets

12-point sockets, common in Aircraft Maintenance and Engineering, are ideal for use in confined space and for fast lightweight work. 6-point sockets are ideal for when extra torque needs to be applied. They are designed to contact the head of a fastener well away from the corners, this dramatically reduces the likelihood of slippage and rounding over of the corners.



SOCKETS & ACCESSORIES



3/8" DEEP SOCKET 6 PT METRIC



	(mm)	1 (mm)	2 (mm)			
M380607-C	7 mm	45.5	10.8	16.5	30 g	£9.60
M380608-C	8 mm	45.5	12	16.5	31 g	£9.60
M380609-C	9 mm	45.5	13.1	16.5	34 g	£9.60
M380610-C	10 mm	45.5	14.7	16.5	36 g	£9.60
M380611-C	11 mm	45.5	16.5	16.5	37 g	£9.60
M380612-C	12 mm	45.5	17.1	17.1	38 g	£9.70
M380613-C	13 mm	45.5	18.5	18.5	49 g	£9.70
M380614-C	14 mm	50	19.5	19.5	60 g	£9.80
M380615-C	15 mm	53	20.4	20.4	68 g	£9.80
M380616-C	16 mm	53	22	22	83 g	£11.60
M380617-C	17 mm	56	23.3	23.3	99 g	£11.70
M380618-C	18 mm	56	24.2	24.2	107 g	£11.70
M380619-C	19 mm	56	25.7	25.7	118 g	£12.70
M380620-C	20 mm	63.5	26.8	26.8	155 g	£12.80
M380621-C	21 mm	63.5	27.7	27.7	164 g	£13.10
M380622-C	22 mm	63.5	29.5	29.5	201 g	£13.20



3/8" DEEP SOCKET 12 PT METRIC



	(mm)	1 (mm)	2 (mm)			
M38060712-C	7 mm	45.5	10.8	16.5	30 g	£9.60
M38060812-C	8 mm	45.5	12.8	16.5	31 g	£9.60
M38060912-C	9 mm	45.5	13.1	16.5	34 g	£9.60
M38061012-C	10 mm	45.5	14.7	16.5	36 g	£9.60
M38061112-C	11 mm	45.5	16	16.5	37 g	£9.60
M38061212-C	12 mm	45.5	17.1	17.1	38 g	£9.70
M38061312-C	13 mm	45.5	18.5	18.5	49 g	£9.70
M38061412-C	14 mm	50	19.5	19.5	60 g	£9.80
M38061512-C	15 mm	53	20.4	20.4	68 g	£9.80
M38061612-C	16 mm	53	22	22	83 g	£11.60
M38061712-C	17 mm	56	13.3	13.3	99 g	£11.70
M38061812-C	18 mm	56	24.2	24.2	107 g	£11.70
M38061912-C	19 mm	56	25.7	25.7	118 g	£12.60
M38062012-C	20 mm	63.5	26.8	26.8	155 g	£12.70
M38062112-C	21 mm	63.5	27.7	27.7	164 g	£13.10
M38062212-C	22 mm	63.5	29.5	29.5	201 g	£13.20



3/8" DEEP SOCKET 6 PT AF



M380212-C	3/8 in	45.5	14.2	16.5	43 g	£9.00
M380214-C	7/16 in	45.5	16.5	16.5	50 g	£9.00
M380216-C	1/2 in	45.5	18.5	18.5	62 g	£9.00
M380218-C	9/16 in	50	19.5	19.5	72 g	£9.40
M380220-C	5/8 in	53	22	22	97 g	£9.50
M380222-C	11/16 in	56	24.2	24.2	125 g	£10.80
M380224-C	3/4 in	56	25.7	25.7	130 g	£12.20
M380226-C	13/16 in	63.5	27.7	27.7	140 g	£13.40
M380228-C	7/8 in	63.5	29.5	29.5	165 g	£14.10



3/8" DEEP SOCKET 12 PT AF



M38021212-C	3/8 in	45.5	14.2	16.5	43 g	£9.00
M38021412-C	7/16 in	45.5	16.5	16.5	50 g	£9.00
M38021612-C	1/2 in	45.5	18.5	18.5	62 g	£9.00
M38021812-C	9/16 in	50	19.5	19.5	72 g	£9.40
M38022012-C	5/8 in	53	22	22	97 g	£9.40
M38022212-C	11/16 in	56	24.2	24.2	125 g	£10.80
M38022412-C	3/4 in	56	25.7	25.7	130 g	£12.20

Size clearly etched on the side of every socket

AF

mm

Made from extra strong chrome vanadium steel

Easily identify between metric & AF sockets as 2 rings are etched on the side of each metric socket and 1 ring on each AF socket



SOCKETS & ACCESSORIES



3/8" T-BAR DEEP SOCKET 6 PT METRIC



TBSKT07	7 mm	300	10	202 g	£24.40
TBSKT08	8 mm	300	12	204 g	£25.00
TBSKT10	10 mm	300	15	220 g	£25.00
TBSKT12	12 mm	300	17	309 g	£25.20
TBSKT13	13 mm	300	19	315 g	£25.80
TBSKT14	14 mm	300	20	329 g	£26.20
TBSKT17	17 mm	300	23.5	426 g	£29.30
TBSKT19	19 mm	300	26	439 g	£29.30



3/8" HEX BIT SOCKET METRIC



M381503-C	3 mm	49.5	23	17.9	38 g £9.90
M381504-C	4 mm	49.5	23	17.9	40 g £9.90
M381505-C	5 mm	49.5	23	17.9	45 g £9.90
M3815055-C	5.5 mm	49.5	23	17.9	45 g £9.90
M381506-C	6 mm	49.5	23	17.9	48 g £9.90
M381507-C	7 mm	49.5	23	17.9	48 g £10.00
M381508-C	8 mm	49.5	23	17.9	48 g £10.00
M381510-C	10 mm	49.5	23	17.9	52 g £10.00
M381512-C	12 mm	49.5	23	22	54 g £11.10



3/8" LONG HEX BIT SOCKET METRIC



M382503-C	3 mm	100	74	17.9	48 g	£11.80
M382504-C	4 mm	100	74	17.9	50 g	£11.80
M382505-C	5 mm	100	74	17.9	50 g	£11.80
M3825055-C	5.5 mm	100	74	17.9	50 g	£11.80
M382506-C	6 mm	100	74	17.9	50 g	£11.80
M382507-C	7 mm	100	74	17.9	55 g	£12.00
M382508-C	8 mm	100	74	17.9	66 g	£12.30
M382510-C	10 mm	100	74	17.9	86 g	£13.70
M382512-C	12 mm	100	74	17.9	130 g	£16.00



3/8" HEX BIT SOCKET BALL POINT METRIC



M381503BL-C	3 mm	100	74	17.8	48 g	£11.30
M381504BL-C	4 mm	100	74	17.8	48 g	£11.30
M3815055BL-C	5.5 mm	100	74	17.8	49 g	£11.30
M381505BL-C	5 mm	100	74	17.8	49 g	£11.30
M381506BL-C	6 mm	100	74	17.8	49 g	£11.30
M381507BL-C	7 mm	100	74	17.8	61 g	£12.30
M381508BL-C	8 mm	100	74	17.8	78 g	£14.40
M381510BL-C	10 mm	100	74	17.8	81 g	£14.40
M381512BL-C	12 mm	100	74	22	123 g	£17.10



SOCKETS & ACCESSORIES



3/8" HEX BIT SOCKET AF



		1 (mm)	2 (mm)	(mm)		
M381103-C	3/32 in	49.5	23	17.9	38 g	£10.00
M381104-C	1/8 in	49.5	23	17.9	38 g	£10.00
M381105-C	5/32 in	49.5	23	17.9	38 g	£10.00
M381106-C	3/16 in	49.5	23	17.9	38 g	£10.00
M381107-C	7/32 in	49.5	23	17.9	38 g	£10.00
M381108-C	1/4 in	49.5	23	17.9	38 g	£10.00
M381110-C	5/16 in	49.5	23	17.9	44 g	£10.00
M381112-C	3/8 in	49.5	23	17.9	44 g	£10.00



3/8" LONG RIBE® BIT SOCKET



		1 (mm)	2 (mm)	(mm)		
M382704-C	4	100	74	17.9	40 g	£10.50
M382705-C	5	100	74	17.9	43 g	£10.50
M382706-C	6	100	74	17.9	47 g	£10.50
M382708-C	8	100	74	17.9	60 g	£13.10
M382709-C	9	100	74	17.9	68 g	£13.10



3/8" TX BIT SOCKET



		1 (mm)	2 (mm)	(mm)		
M381210T-C	TX10	49.5	23	17.9	38 g	£10.10
M381215T-C	TX15	49.5	23	17.9	38 g	£10.10
M381220T-C	TX20	49.5	23	17.9	40 g	£10.10
M381225T-C	TX25	49.5	23	17.9	40 g	£10.10
M381227T-C	TX27	49.5	23	17.9	43 g	£10.10
M381230T-C	TX30	49.5	23	17.9	45 g	£10.10
M381240T-C	TX40	49.5	23	17.9	50 g	£10.10
M381245T-C	TX45	49.5	23	17.9	53 g	£10.00
M381250T-C	TX50	49.5	23	17.9	56 g	£10.00



3/8" LONG TX BIT SOCKET



M382210T-C	TX10	100	74	17.9	48 g	£12.30
M382215T-C	TX15	100	74	17.9	48 g	£12.30
M382220T-C	TX20	100	74	17.9	50 g	£12.30
M382225T-C	TX25	100	74	17.9	50 g	£12.30
M382227T-C	TX27	100	74	17.9	50 g	£12.30
M382230T-C	TX30	100	74	17.9	50 g	£12.30
M382240T-C	TX40	100	74	17.9	50 g	£12.30
M382245T-C	TX45	100	74	17.9	65 g	£13.40
M382250T-C	TX50	100	74	17.9	65 g	£13.40



3/8" TPX BIT SOCKET



M381210-C	TPX10	49.5	23	17.9	38 g	£10.10
M381215-C	TPX15	49.5	23	17.9	38 g	£10.10
M381220-C	TPX20	49.5	23	17.9	40 g	£10.10
M381225-C	TPX25	49.5	23	17.9	40 g	£10.10
M381227-C	TPX27	49.5	23	17.9	43 g	£10.10
M381230-C	TPX30	49.5	23	17.9	45 g	£10.10
M381240-C	TPX40	49.5	23	17.9	50 g	£10.10
M381245-C	TPX45	49.5	23	17.9	53 g	£10.00
M381250-C	TPX50	49.5	23	17.9	56 g	£10.00



3/8" TX-E SOCKET



M380710-C	E10	28	13	17	25 g	£7.00
M380712-C	E12	28	15	17	25 g	£7.00
M380714-C	E14	28	16.3	18	30 g	£7.00
M380716-C	E16	28	20	20	43 g	£7.00
M380718-C	E18	28	22	22	55 g	£7.00

SOCKETS & ACCESSORIES



1/2" SOCKET 6 PT METRIC



	(mm)	(mm)	1 (mm)	2 (mm)	(g)	
M1205086-C	8 mm	38	13.3	21.8	45 g	£7.20
M1205106-C	10 mm	38	15.5	21.8	45 g	£7.20
M1205116-C	11 mm	38	16.7	21.8	47 g	£7.40
M1205126-C	12 mm	38	18	21.8	49 g	£7.40
M1205136-C	13 mm	38	19.2	21.8	50 g	£7.40
M1205146-C	14 mm	38	20.5	21.8	50 g	£7.40
M1205156-C	15 mm	38	21	21.8	51 g	£8.10
M1205166-C	16 mm	38	22.5	23.3	55 g	£8.30
M1205176-C	17 mm	38	24.2	23	57 g	£8.50
M1205186-C	18 mm	38	24.7	23	61 g	£8.60
M1205196-C	19 mm	38	26.3	24	63 g	£8.80
M1205206-C	20 mm	38	27	24	66 g	£9.50
M1205216-C	21 mm	38	28	24	71 g	£9.50
M1205226-C	22 mm	40	29.8	26	97 g	£10.00
M1205236-C	23 mm	40	30.8	26	96 g	£10.10
M1205246-C	24 mm	40	31.8	26	93 g	£11.30
M1205256-C	25 mm	40	33.4	28	136 g	£12.30
M1205266-C	26 mm	40	34.8	29	140 g	£12.70
M1205276-C	27 mm	43	35.8	30	148 g	£13.10
M1205286-C	28 mm	43	37.8	31	172 g	£14.00
M1205296-C	29 mm	43	38.8	32	180 g	£14.70
M1205306-C	30 mm	43	39.8	33	180 g	£14.80
M1205326-C	32 mm	43	41.8	35	201 g	£16.60
M1205336-C	33 mm	45.5	42.8	35	235 g	£18.00
M1205346-C	34 mm	45.5	43.8	36	223 g	£18.20

1/2" SOCKET 12 PT METRIC



	(mm)	(mm)	1 (mm)	2 (mm)	(g)	
M120508-C	8 mm	38	13	21.8	43 g	£7.20
M120509-C	9 mm	38	14.5	21.8	45 g	£7.20
M120510-C	10 mm	38	15.5	21.8	45 g	£7.20
M120511-C	11 mm	38	16.7	21.8	47 g	£7.40
M120512-C	12 mm	38	18	21.8	49 g	£7.40
M120513-C	13 mm	38	19.2	21.8	50 g	£7.40
M120514-C	14 mm	38	20.5	21.8	50 g	£7.40
M120515-C	15 mm	38	21	21.8	51 g	£8.10
M120516-C	16 mm	38	22.5	23.3	55 g	£8.30
M120517-C	17 mm	38	24.2	23	57 g	£8.50
M120518-C	18 mm	38	24.7	23	61 g	£8.60
M120519-C	19 mm	38	26.3	24	63 g	£8.80
M120520-C	20 mm	38	27	23.7	66 g	£9.50
M120521-C	21 mm	38	28	24	68 g	£9.50
M120522-C	22 mm	40	29.8	26	92 g	£10.00
M120523-C	23 mm	40	30.8	26	92 g	£10.10
M120524-C	24 mm	40	31.8	26	95 g	£11.30
M120525-C	25 mm	40	33.4	28	136 g	£12.30
M120526-C	26 mm	40	34.8	29	140 g	£12.70
M120527-C	27 mm	43	35.8	30	148 g	£13.10
M120528-C	28 mm	43	37.8	31	172 g	£14.00
M120529-C	29 mm	43	38.8	32	180 g	£14.70
M120530-C	30 mm	43	39.8	33	172 g	£14.80
M120532-C	32 mm	43	41.8	35	189 g	£16.60
M120534-C	34 mm	45.5	43.8	36	223 g	£18.20



1/2" SOCKET 12 PT AF



		(mm)	1 (mm)	2 (mm)		
M120112-C	3/8 in	38	14.7	21.8	52 g	£7.50
M120114-C	7/16 in	38	17	21.8	55 g	£7.50
M120116-C	1/2 in	38	19	21.8	57 g	£7.50
M120118-C	9/16 in	38	20.8	21.8	59 g	£7.50
M120119-C	19/32 in	38	21	21.8	51 g	£8.20
M120120-C	5/8 in	38	22.5	23.3	70 g	£8.60
M120122-C	11/16 in	38	24.2	23.5	73 g	£8.60
M120124-C	3/4 in	38	26.3	24	71 g	£8.90
M120125-C	25/32 in	38	26.8	24	66 g	£9.00
M120126-C	13/16 in	38	27.7	24	73 g	£9.00
M120128-C	7/8 in	40	29.8	26	88 g	£9.40
M120130-C	15/16 in	40	31.8	26	103 g	£9.90
M120132-C	1 in	43	33.8	27.5	113 g	£11.00
M120134-C	1-1/16 in	43	35.8	29	138 g	£13.00
M120136-C	1-1/8 in	43	37.8	30.5	143 g	£14.20
M120138-C	1-3/16 in	43	39.8	32.5	183 g	£14.60
M120140-C	1-1/4 in	43	40.8	34	198 g	£16.00



1/2" DEEP SOCKET 6 PT METRIC



		(mm)	1 (mm)	2 (mm)		
M1206136-C	13 mm	79	19.2	22	119 g	£14.90
M1206146-C	14 mm	79	20.5	22	135 g	£15.40
M1206156-C	15 mm	79	21.5	22	135 g	£15.40
M1206166-C	16 mm	79	22.5	23.3	150 g	£15.40
M1206176-C	17 mm	79	24.2	24.2	155 g	£15.80
M1206186-C	18 mm	79	25.4	25.4	165 g	£15.80
M1206196-C	19 mm	79	26.7	26.7	190 g	£15.80
M1206246-C	24 mm	79	31.8	31.8	240 g	£16.90



SOCKETS & ACCESSORIES



1/2" DEEP SOCKET 12 PT METRIC



	(mm)	1 (mm)	2 (mm)			
M120610-C	10 mm	79	15.5	22	98 g	£14.90
M120611-C	11 mm	79	16.7	22	103 g	£14.90
M120612-C	12 mm	79	18	22	130 g	£14.90
M120613-C	13 mm	79	19.2	22	116 g	£14.90
M120614-C	14 mm	79	20.5	22	135 g	£15.40
M120615-C	15 mm	79	21.5	22	135 g	£15.40
M120616-C	16 mm	79	22.5	23.3	150 g	£15.40
M120617-C	17 mm	79	24.2	24.2	152 g	£15.80
M120618-C	18 mm	79	25.4	25.4	165 g	£15.80
M120619-C	19 mm	79	26.7	26.7	186 g	£15.80
M120620-C	20 mm	79	27.8	27.8	195 g	£15.80
M120621-C	21 mm	79	27.8	27.8	200 g	£16.30
M120622-C	22 mm	79	29.8	29.8	230 g	£16.30
M120624-C	24 mm	79	31.8	31.8	240 g	£16.90
M120627-C	27 mm	79	35.8	35.8	280 g	£21.90
M120630-C	30 mm	79	39.8	39.8	360 g	£24.70
M120632-C	32 mm	79	41.3	41.3	380 g	£25.00
M120636-C	36 mm	79	46	46	390 g	£28.90



1/2" HEX BIT SOCKET METRIC



		1 (mm)	2 (mm)	(mm)		
M121505-C	5 mm	55	20.5	22	52 g	£10.40
M121506-C	6 mm	55	20.5	22	54 g	£10.40
M121507-C	7 mm	55	20.5	22	60 g	£10.40
M121508-C	8 mm	55	20.5	22	62 g	£10.40
M121509-C	9 mm	55	20.5	22	66 g	£10.40
M121510-C	10 mm	55	20.5	22	72 g	£11.20
M121512-C	12 mm	55	20.5	22	80 g	£12.20
M121514-C	14 mm	55	20.5	22	96 g	£14.50
M121516-C	16 mm	55	20.5	22	130 g	£15.90
M121517-C	17 mm	55	20.5	22	154 g	£17.40
M121519-C	19 mm	60	23	25.9	182 g	£18.60



1/2" HEX BIT SOCKET AF



M121106-C	3/16 in	55	20	22	55 g	£10.90
M121107-C	7/32 in	55	20	22	55 g	£10.90
M121108-C	1/4 in	55	20	22	55 g	£10.90
M121109-C	9/32 in	55	20	22	60 g	£11.00
M121110-C	5/16 in	55	20	22	62 g	£11.00
M121112-C	3/8 in	55	20	22	67 g	£11.40
M121116-C	1/2 in	55	20	22	85 g	£12.40
M121118-C	9/16 in	55	20	22	100 g	£15.20
M121120-C	5/8 in	55	20	22	120 g	£17.90



1/2" LONG HEX BIT SOCKET METRIC



M122505-C	5 mm	100	65.5	22	60 g	£10.60
M122506-C	6 mm	100	65.5	22	60 g	£10.60
M122507-C	7 mm	100	65.5	22	80 g	£10.60
M122508-C	8 mm	100	65.5	22	80 g	£10.60
M122510-C	10 mm	100	65.5	22	100 g	£12.90
M122512-C	12 mm	100	65.5	22	120 g	£13.90
M122514-C	14 mm	100	65.5	22	153 g	£15.60
M122517-C	17 mm	100	65.5	25	225 g	£19.20
M122506A-C	6 mm	115	80	22	70 g	£12.70
M122508A-C	8 mm	115	80	22	70 g	£12.70
M122510L-C	10 mm	175	140	22	153 g	£15.50



Do's and Don'ts of Socketry

DO'S

- Use the right drive
- Use the correct socket size
- Check the thread direction
- Keep it clean and dry
- Use light oil on ratchet mechanisms

DONT'S

- Do not use with impact tools
- Do not use TPX on a TX fastenings
- Do not use poles to increase leverage



SOCKETS & ACCESSORIES



1/2" TX BIT SOCKET



M121220T-C	TX20	55	20.5	22	60 g	£10.00
M121225T-C	TX25	55	20.5	22	60 g	£10.00
M121227T-C	TX27	55	20.5	22	60 g	£10.00
M121230T-C	TX30	55	20.5	22	65 g	£10.00
M121240T-C	TX40	55	20.5	22	65 g	£10.00
M121245T-C	TX45	55	20.5	22	68 g	£11.10
M121250T-C	TX50	55	20.5	22	68 g	£11.10
M121255T-C	TX55	55	20.5	22	68 g	£12.30
M121260T-C	TX60	55	20.5	22	68 g	£13.00



1/2" LONG TX BIT SOCKET



M122220T-C	TX20	100	65.5	22	60 g	£16.00
M122225T-C	TX25	100	65.5	22	60 g	£16.00
M122227T-C	TX27	100	65.5	22	65 g	£16.00
M122230T-C	TX30	100	65.5	22	70 g	£16.00
M122240T-C	TX40	100	65.5	22	75 g	£16.00
M122245T-C	TX45	100	65.5	22	80 g	£17.20
M122250T-C	TX50	100	65.5	22	100 g	£17.20
M122255T-C	TX55	100	65.5	22	100 g	£19.50
M122260T-C	TX60	100	65.5	22	100 g	£21.30
M122270T-C	TX70	100	65.5	22	100 g	£21.60



1/2" TX CYLINDER HEAD BIT SOCKET



120955-C	TX55	125	87	22	117 g	£13.60



1/2" TPX BIT SOCKET



		1 (mm)	2 (mm)	(mm)		
M121220-C	TPX20	55	20.5	22	51 g	£10.00
M121225-C	TPX25	55	20.5	22	60 g	£10.00
M121227-C	TPX27	55	20.5	22	60 g	£10.00
M121230-C	TPX30	55	20.5	22	65 g	£10.00
M121240-C	TPX40	55	20.5	22	65 g	£10.00
M121245-C	TPX45	55	20.5	22	68 g	£11.10
M121250-C	TPX50	55	20.5	22	68 g	£11.10
M121255-C	TPX55	55	20.5	22	68 g	£12.30
M121260-C	TPX60	55	20.5	22	68 g	£13.00



1/2" TX-E SOCKET



		(mm)	1 (mm)	2 (mm)		
M120710-C	E10	37.8	13.1	23.5	39 g	£9.90
M120711-C	E11	37.8	14.1	23.5	42 g	£9.90
M120712-C	E12	37.8	14.9	23.5	43 g	£9.90
M120714-C	E14	37.8	16.7	23.5	44 g	£9.90
M120716-C	E16	37.8	19.1	23.5	49 g	£9.90
M120718-C	E18	37.8	20.9	23.5	52 g	£10.90
M120720-C	E20	37.8	23.5	23.5	60 g	£11.30
M120722-C	E22	37.8	26.1	26.1	82 g	£11.30
M120724-C	E24	37.8	28	28	102 g	£11.60





1/2" LONG RIBE® BIT SOCKET



M122704-C	4	100	65	22	70 g	£14.90
M122705-C	5	100	65	22	75 g	£14.90
M122706-C	6	100	65	22	80 g	£14.90
M122708-C	8	100	65	22	85 g	£14.90
M122709-C	9	100	65	22	90 g	£17.00
M122710-C	10	100	65	22	90 g	£18.00
M122711-C	11	100	65	22	100 g	£20.60
M122712-C	12	100	65	22	110 g	£23.50
M122713-C	13	100	65	22	120 g	£25.20



1/2" LONG XZN/TRIPLE SQUARE BIT SOCKET



M122805-C	5	100	65	22	70 g	£15.00
M122806-C	6	100	65	22	80 g	£15.00
M122808-C	8	100	65	22	85 g	£15.00
M122809-C	9	100	65	22	85 g	£15.90
M122810-C	10	100	65	22	90 g	£18.00
M122812-C	12	100	65	22	110 g	£20.90
M122814-C	14	100	65	22	130 g	£22.50
M122816-C	16	100	65	22	160 g	£24.90





3/4" SOCKET 6 PT METRIC



	(mm)	1 (mm)	2 (mm)		
M3405196-C	19 mm	50	29.2	33	180 g £15.50
M3405216-C	21 mm	50	31.2	33	180 g £15.50
M3405226-C	22 mm	50	32.2	36	220 g £15.50
M3405246-C	24 mm	51	34.2	36	230 g £15.50
M3405266-C	26 mm	52	36	36	240 g £15.50
M3405276-C	27 mm	52	38	36	240 g £16.00
M3405306-C	30 mm	54	42	38	260 g £16.90
M3405326-C	32 mm	56	44	38	310 g £17.90
M3405336-C	33 mm	56	46	38	330 g £19.20
M3405346-C	34 mm	56	47	38	350 g £20.00
M3405366-C	36 mm	58	50	38	430 g £21.60
M3405386-C	38 mm	60	52	42	500 g £24.00
M3405416-C	41 mm	64	56	45	570 g £27.00
M3405466-C	46 mm	68	62	45	690 g £31.00
M3405506-C	50 mm	72	68	48	830 g £35.10



3/4" SOCKET 12 PT AF



	(mm)	1 (mm)	2 (mm)		
M340124-C	3/4 in	50	29.2	33	180 g £16.40
M340128-C	7/8 in	51	32.2	36.2	195 g £16.40
M340130-C	15/16 in	51	34.5	36.2	200 g £16.40
M340132-C	1 in	51	37	37	200 g £16.40
M340134-C	1-1/16 in	51	38.3	37	200 g £16.60
M340136-C	1-1/8 in	51	40	38.5	230 g £17.80
M340138-C	1-3/16 in	55	42	38.5	255 g £18.10
M340140-C	1-1/4 in	55	44	38.5	275 g £18.80
M340142-C	1-5/16 in	55	46	38.5	300 g £19.10
M340144-C	1-3/8 in	57	48	42.3	360 g £24.20
M340146-C	1-7/16 in	57	50	42.3	380 g £25.20
M340148-C	1-1/2 in	60	52.1	45.2	440 g £26.00
M340152-C	1-5/8 in	63	56.1	45.2	515 g £28.10
M340156-C	1-3/4 in	65	60	48	610 g £31.80
M340158-C	1-13/16 in	67	62	48	635 g £32.90
M340160-C	1-7/8 in	69	64	48.3	690 g £34.40
M340164-C	2 in	71	68.2	48.3	755 g £37.50





3/4" HEX BIT SOCKET METRIC



M341514-C	14 mm	78.5	36	326 g	£32.30
M341517-C	17 mm	78.5	36	330 g	£32.30
M341519-C	19 mm	78.5	36	334 g	£32.30
M341522-C	22 mm	78.5	36	338 g	£32.30



1" SOCKET 12 PT METRIC



M110536	36 mm	65.3	51	45.2	440 g	£38.30
M110541	41 mm	70.2	57.1	45.2	550 g	£42.30
M110546	46 mm	74.5	64.6	49.4	810 g	£50.90
M110550	50 mm	75.3	69.9	55.2	995 g	£58.90
M110555	55 mm	80	76.2	57.3	1160 g	£66.50
M110558	58 mm	80	79.2	57.3	1250 g	£67.90
M110560	60 mm	84	82.1	57.3	1410 g	£73.90
M110565	65 mm	87.3	88	57.3	1540 g	£92.90
M110570	70 mm	93.4	94	68.1	2020 g	£102.90
M110575	75 mm	96.1	94	68.1	2020 g	£113.90
M110580	80 mm	103.6	105	68.1	2500 g	£132.90



3/8" IMPACT ADAPTORS



		1	2			
980020-C		3/8"		77 g	DIN (F) & ANSI (M)	£18.70
980035-C	Reducing	3/8"	1/4"	44 g	DIN	£12.50
980036-C	Step-up	3/8"	1/2"	60 g	DIN	£15.60
980036A-C	Step-up	3/8"	1/2"	60 g	DIN (F) & ANSI (M)	£13.20
980060-C	Hex bit coupler	3/8"	1/4" Hex	25 g	ANSI	£10.10
980086	Hex coupler	5/16" Hex	3/8"	20 g		£9.10



3/4" IMPACT ADAPTORS



		1	2			
940022-C	7" Ext	3/4"		600 g	DIN	£54.70
940030-C	Universal joint	3/4"		533 g	DIN	£82.80
940037-C	Reducing	3/4"	1/2"	500 g	DIN	£39.90
940085-C	Step-up	3/4"	1"	500 g	DIN	£33.90



1/2" IMPACT ADAPTORS



		1	2			
920020AN	3" Ext	1/2"		170 g	DIN (F) & ANSI (M)	£15.00
920020N	3" Ext	1/2"		170 g	DIN	£15.50
920021AN	5" Ext	1/2"		230 g	DIN (F) & ANSI (M)	£20.10
920021N	5" Ext	1/2"		230 g	DIN	£20.90
920023AN	10" Ext	1/2"		440 g	DIN (F) & ANSI (M)	£32.50
920023N	10" Ext	1/2"		440 g	DIN	£33.60
920030AN	Universal joint	1/2"		210 g	DIN (F) & ANSI (M)	£30.30
920030N	Universal joint	1/2"		210 g	DIN	£31.40
920036AN	Reducing	1/2"	3/8"	55 g	DIN (F) & ANSI (M)	£15.30
920036N	Reducing	1/2"	3/8"	55 g	DIN	£15.30
920037AN	Step-up	1/2"	3/4"	105 g	DIN (F) & ANSI (M)	£24.80
920037N	Step-up	1/2"	3/4"	105 g	DIN	£25.60
920060-C	Hex bit coupler	1/2"	5/16" Hex	57 g	ANSI	£11.00



IMPACT REDUCING ADAPTOR



		1	2			
910086	Reducing	1"	3/4"	625 g	DIN	£52.20

SOCKETS & ACCESSORIES



RETAINING RING



O9100115	115 × 10 mm	1 g		£18.80
O910075	75 × 10 mm	1 g		£16.50
O92194	19 × 4 mm	1 g		£3.00
O92244	24 × 4 mm	1 g		£3.50
O95034	34 × 5 mm	1 g		£5.00
O95036	36 × 5 mm	1 g		£5.00
O95046	46 × 5 mm	1 g		£5.00
O97043	43 × 7 mm	1 g		£5.00
O97045	45 × 7 mm	1 g		£5.00
O97051	51 × 7 mm	1 g		£5.00

RETAINING PIN

P90433	4 × 33 mm	7 g		£5.00
P90435	4 × 35 mm	7 g		£5.00
P90445	4 × 45 mm	7 g		£5.00
P90543	5 × 43 mm	7 g		£5.30
P90545	5 × 45 mm	7 g		£5.30
P90551	5 × 51 mm	7 g		£5.30
P906110	6 × 110 mm	7 g		£13.00
P90675	6 × 75 mm	7 g		£13.00
P92320	3 × 20 mm	1 g		£3.20
P92325	3 × 25 mm	1 g		£3.70



1/4" IMPACT SOCKET ANSI METRIC



960506-C	6 mm	25	10.3	13.1	20 g	£6.00
960507-C	7 mm	25	12	13.1	20 g	£6.00
960508-C	8 mm	25	13.1	13.1	22 g	£6.00
960510-C	10 mm	25	15.9	15.9	25 g	£6.20
960513-C	13 mm	25	19.8	19.8	28 g	£6.40



DIN Standard sockets require a retaining ring and pin to safely secure the socket to the impact tool.





3/8" IMPACT SOCKET ANSI METRIC



	(mm)	1 (mm)	2 (mm)			
980508-C	8 mm	29.5	12.8	19	33 g	£7.10
980510-C	10 mm	29.5	15	19	34 g	£7.10
980511-C	11 mm	29.5	17	19	37 g	£7.10
980512-C	12 mm	29.5	19	19	40 g	£7.10
980513-C	13 mm	29.5	22	22	40 g	£7.20
980514-C	14 mm	29.5	22	22	64 g	£7.60
980515-C	15 mm	30	22	22	64 g	£7.60
980516-C	16 mm	29.5	23.8	23.8	64 g	£7.70
980517-C	17 mm	29.5	25	25	64 g	£7.70
980519-C	19 mm	29.5	27.8	27.8	72 g	£8.00

3/8" DEEP IMPACT SOCKET ANSI METRIC



	(mm)	1 (mm)	2 (mm)			
980608-C	8 mm	63	12.8	19	95 g	£9.60
980610-C	10 mm	63	15	19	95 g	£9.90
980611-C	11 mm	63	17	19	95 g	£9.90
980612-C	12 mm	63	19	19	95 g	£10.10
980613-C	13 mm	63	22	22	100 g	£10.10
980614-C	14 mm	63	22	22	100 g	£10.40
980616-C	16 mm	63	24	24	144 g	£11.20
980617-C	17 mm	63	25	25	146 g	£11.20
980619-C	19 mm	63	27.8	27.8	150 g	£12.00



SOCKETS & ACCESSORIES



3/8" HEX BIT IMPACT SOCKET DIN METRIC



		(mm)	1 (mm)					
981504-C	4 mm	52	20.8	P90320	O935202	55 g	£13.40	
981505-C	5 mm	52	20.8	P90320	O935202	57 g	£13.40	
981506-C	6 mm	52	20.8	P90320	O935202	60 g	£13.40	
981507-C	7 mm	52	20.8	P90320	O935202	63 g	£13.40	
981508-C	8 mm	52	20.8	P90320	O935202	67 g	£13.40	
981510-C	10 mm	52	20.8	P90320	O935202	74 g	£14.20	
981512-C	12 mm	52	20.8	P90320	O935202	85 g	£14.20	



1/2" IMPACT SOCKET DIN METRIC



		(mm)	1 (mm)	2 (mm)					
920508N	8 mm	38	15	25	P92320	O92194	75 g	£8.90	
920510N	10 mm	38	17	25	P92320	O92194	80 g	£8.90	
920511N	11 mm	38	18.5	25	P92320	O92194	85 g	£8.90	
920512N	12 mm	38	20	25	P92320	O92194	85 g	£8.90	
920513N	13 mm	38	21	25	P92320	O92194	80 g	£8.90	
920514N	14 mm	38	22.5	25	P92320	O92194	80 g	£8.90	
920515N	15 mm	38	23	30	P92325	O92244	125 g	£9.90	
920516N	16 mm	38	25	30	P92325	O92244	125 g	£9.80	
920517N1	17 mm	38	26	30	P92325	O92244	120 g	£9.80	
920518N	18 mm	38	27.5	30	P92325	O92244	125 g	£9.80	
920519N1	19 mm	38	28.5	30	P92325	O92244	125 g	£9.80	
920520N	20 mm	38	30	30	P92325	O92244	140 g	£9.80	
920521N1	21 mm	38	31	30	P92325	O92244	140 g	£10.20	
920522N	22 mm	38	32.5	30	P92325	O92244	140 g	£10.80	
920523N	23 mm	38	34	30	P92325	O92244	140 g	£11.70	
920524N	24 mm	38	35	30	P92325	O92244	170 g	£12.70	
920525N	25 mm	45	36	30	P92325	O92244	175 g	£12.90	
920526N	26 mm	45	37.5	30	P92325	O92244	180 g	£14.20	
920527N	27 mm	45	38.5	30	P92325	O92244	195 g	£15.20	
920528N	28 mm	47	40	30	P92325	O92244	200 g	£15.50	
920529N	29 mm	47	41	30	P92325	O92244	210 g	£15.90	
920530N	30 mm	50	42	30	P92325	O92244	225 g	£16.20	
920532N	32 mm	50	44	30	P92325	O92244	225 g	£17.40	



1/2" IMPACT SOCKET ANSI METRIC



		(mm)	1 (mm)	2 (mm)		
920510AN	10 mm	38	17	22	53 g	£7.40
920511AN	11 mm	38	17	22	51 g	£7.40
920512AN	12 mm	38	19	22	54 g	£7.40
920513AN	13 mm	38	20	24	69 g	£7.40
920514AN	14 mm	38	21	24	68 g	£7.40
920515AN	15 mm	38	23	25	76 g	£7.70
920516AN	16 mm	38	25	25	88 g	£8.00
920517AN	17 mm	38	26	26	96 g	£8.00
920518AN	18 mm	38	28	26	97 g	£8.00
920519AN	19 mm	38	28	28	110 g	£9.80
920521AN	21 mm	38	30	30	123 g	£9.80
920522AN	22 mm	38	32	32	147 g	£10.00
920524AN	24 mm	38	36	36	192 g	£11.00



1/2" IMPACT SOCKET DIN AF



		(mm)	1 (mm)	2 (mm)			
920112	3/8 in	38	16.1	24	P92320 O92194	85 g	£9.10
920114	7/16 in	38	17.8	24	P92320 O92194	85 g	£9.10
920116	1/2 in	38	19.9	24	P92320 O92194	85 g	£9.10
920118	9/16 in	38	21.9	24	P92320 O92194	85 g	£9.10
920120	5/8 in	38	24	24	P92320 O92194	125 g	£9.60
920122	11/16 in	38	26	26	P92325 O92244	125 g	£10.10
920124	3/4 in	38	30	30	P92325 O92244	125 g	£10.30
920126	13/16 in	38	30	30	P92325 O92244	135 g	£10.30
920128	7/8 in	38	32	30	P92325 O92244	140 g	£10.60
920130	15/16 in	38	33.9	30	P92325 O92244	170 g	£11.40
920132	1 in	40	35.6	30	P92325 O92244	175 g	£12.40
920134	1-1/16 in	42	37.6	30	P92325 O92244	205 g	£13.20
920136	1-1/8 in	42	39.8	30	P92325 O92244	205 g	£14.80
920140	1-1/4 in	44	44	30	P92325 O92244	225 g	£15.80



SOCKETS & ACCESSORIES



1/2" STUBBY IMPACT SOCKET DIN METRIC



	mm	(mm)	1 (mm)	2 (mm)				
920710-C	10 mm	28	18	24	P92320	O92194	65 g	£10.00
920713-C	13 mm	30	20	24	P92320	O92194	65 g	£10.00
920714-C	14 mm	31	22	24	P92320	O92194	65 g	£10.30
920716-C	16 mm	33	24	24	P92320	O92194	66 g	£10.30
920717-C	17 mm	34	26	26	P92325	O92244	66 g	£11.50
920721-C	21 mm	37	30	30	P92325	O92244	82 g	£11.90



1/2" DEEP IMPACT SOCKET DIN METRIC



	mm	(mm)	1 (mm)	2 (mm)				
920610N	10 mm	80	17	25	P92320	O92194	140 g	£16.20
920611N	11 mm	80	18.5	25	P92320	O92194	150 g	£16.20
920612N	12 mm	80	20	25	P92320	O92194	160 g	£16.20
920613N	13 mm	80	21	25	P92320	O92194	160 g	£16.20
920614N	14 mm	80	22.5	25	P92320	O92194	170 g	£16.20
920615N	15 mm	80	23	30	P92325	O92244	230 g	£16.40
920616N	16 mm	80	25	30	P92325	O92244	230 g	£16.40
920617N	17 mm	80	26	30	P92325	O92244	260 g	£16.40
920618N	18 mm	80	27.5	30	P92325	O92244	270 g	£16.40
920619N	19 mm	80	28.5	30	P92325	O92244	260 g	£16.40
920620N	20 mm	80	30	30	P92325	O92244	265 g	£16.90
920621N	21 mm	80	31	30	P92325	O92244	270 g	£17.10
920622N	22 mm	80	32.5	30	P92325	O92244	320 g	£17.30
920623N	23 mm	80	34	30	P92325	O92244	320 g	£17.40
920624N	24 mm	80	35	30	P92325	O92244	320 g	£18.90
920627N	27 mm	80	38.5	30	P92325	O92244	350 g	£22.70
920628N	28 mm	80	40	30	P92325	O92244	400 g	£24.40
920629N	29 mm	80	40	30	P92325	O92244	400 g	£24.70
920630N	30 mm	80	42	30	P92325	O92244	450 g	£25.00
920632N	32 mm	80	44	30	P92325	O92244	540 g	£26.50
920635N	35 mm	80	50	30	P92325	O92244	750 g	£29.60
920636N	36 mm	80	50	30	P92325	O92244	840 g	£29.90



1/2" DEEP IMPACT SOCKET ANSI METRIC



	(mm)	1 (mm)	2 (mm)			
920610AN	10 mm	78	17	22	120 g	£13.50
920611AN	11 mm	78	18	22	120 g	£13.50
920612AN	12 mm	78	19	22	120 g	£13.50
920613AN	13 mm	78	22	24	120 g	£13.60
920614AN	14 mm	78	22	24	130 g	£13.90
920615AN	15 mm	78	24	24	130 g	£14.10
920616AN	16 mm	78	24	24	140 g	£14.10
920617AN	17 mm	78	26	26	150 g	£14.10
920618AN	18 mm	78	28	28	170 g	£14.60
920619AN	19 mm	78	28	28	180 g	£14.70
920621AN	21 mm	78	30	30	200 g	£14.80
920622AN	22 mm	78	32	32	220 g	£15.50
920624AN	24 mm	78	35.8	35.8	260 g	£15.70

1/2" DEEP IMPACT SOCKET DIN AF



	(mm)	1 (mm)	2 (mm)			
920212	3/8 in	78	16	24	P92320 O92194	80 g £15.00
920214	7/16 in	78	18	24	P92320 O92194	150 g £15.00
920216	1/2 in	78	20.4	24	P92320 O92194	160 g £15.00
920218	9/16 in	78	22	24	P92320 O92194	170 g £15.00
920220	5/8 in	78	24	24	P92320 O92194	230 g £15.60
920222	11/16 in	78	26	26	P92325 O92244	260 g £15.70
920224	3/4 in	78	28	28	P92325 O92244	260 g £16.80
920226	13/16 in	78	30	30	P92325 O92244	270 g £17.50
920228	7/8 in	78	32	30	P92325 O92244	320 g £18.30
920230	15/16 in	78	34	30	P92325 O92244	320 g £19.20
920232	1 in	78	36	30	P92325 O92244	340 g £20.00
920234	1-1/16 in	78	38	30	P92325 O92244	340 g £23.90
920236	1-1/8 in	78	40	30	P92325 O92244	360 g £25.90
920240	1-1/4 in	78	44.4	30	P92325 O92244	360 g £26.80
920242	1-5/16 in	80	46	30	P92325 O92244	560 g £28.90
920248	1-1/2 in	80	52	30	P92325 O92244	660 g £31.90



SOCKETS & ACCESSORIES



1/2" DOUBLE ENDED IMPACT SOCKET METRIC



		(mm)	1 (mm)	2 (mm)		
9291719	17 x 19 mm	58	26	28	146 g	£14.00
9292122	21 x 22 mm	58	30	32	190 g	£15.80



1/2" HEX IMPACT SOCKET DIN METRIC



		(mm)	1 (mm)			
921505-C	5 mm	78	25	P92320 O92194	81 g	£18.90
921506-C	6 mm	78	25	P92320 O92194	86 g	£18.90
921508-C	8 mm	78	25	P92320 O92194	100 g	£18.90
921510-C	10 mm	78	25	P92320 O92194	114 g	£19.80
921512-C	12 mm	78	25	P92320 O92194	132 g	£19.80
921514-C	14 mm	78	25	P92320 O92194	155 g	£19.80
921517-C	17 mm	78	25	P92320 O92194	191 g	£20.90
921519-C	19 mm	78	25	P92320 O92194	216 g	£20.90



1/2" HEX IMPACT SOCKET DIN AF



		(mm)	1 (mm)			
921606	3/16 in	78	24.8	P92320 O92194	80 g	£20.10
921608	1/4 in	78	24.8	P92320 O92194	90 g	£20.10
921610	5/16 in	78	24.8	P92320 O92194	100 g	£20.10
921612	3/8 in	78	24.8	P92320 O92194	110 g	£21.00
921614	7/16 in	78	24.8	P92320 O92194	130 g	£21.00
921616	1/2 in	78	24.8	P92320 O92194	150 g	£21.00
921618	9/16 in	78	24.8	P92320 O92194	180 g	£21.00
921620	5/8 in	78	24.8	P92325 O92244	190 g	£21.90
921622	11/16 in	78	24.8	P92325 O92244	200 g	£21.90
921624	3/4 in	78	24.8	P92325 O92244	220 g	£21.90

SOCKETS & ACCESSORIES



3/4" IMPACT SOCKET DIN METRIC



	(mm)	1 (mm)					
940519-C	19 mm	50	44	P90435	O95036	255 g	£22.90
940521-C	21 mm	50	44	P90435	O95036	251 g	£23.00
940522-C	22 mm	50	44	P90435	O95036	251 g	£23.10
940523-C	23 mm	50	44	P90435	O95036	256 g	£23.10
940524-C	24 mm	50	44	P90435	O95036	256 g	£23.30
940527-C	27 mm	54	44	P90435	O95036	271 g	£23.90
940528-C	28 mm	54	44	P90435	O95036	301 g	£23.90
940530-C	30 mm	54	44	P90435	O95036	313 g	£25.90
940532-C	32 mm	56	44	P90435	O95036	331 g	£26.50
940533-C	33 mm	56	44	P90435	O95036	396 g	£27.30
940534-C	34 mm	56	44	P90435	O95036	421 g	£30.20
940536-C	36 mm	56	44	P90435	O95036	456 g	£30.20
940538-C	38 mm	58	44	P90435	O95036	466 g	£32.80
940540-C	40 mm	58	44	P90435	O95036	531 g	£36.30
940541-C	41 mm	58	44	P90435	O95036	611 g	£37.00
940546-C	46 mm	63	44	P90435	O95036	776 g	£43.60
940550-C	50 mm	68	44	P90435	O95036	840 g	£48.00
940551-C	51 mm	68	54	P90445	O95046	813 g	£65.20
940552-C	52 mm	71	54	P90445	O95046	1041 g	£65.20
940554-C	54 mm	71	54	P90445	O95046	1110 g	£69.60
940555-C	55 mm	71	54	P90445	O95046	1180 g	£76.10
940556-C	56 mm	71	54	P90445	O95046	1136 g	£82.60
940557-C	57 mm	73	54	P90445	O95046	1251 g	£82.60
940558-C	58 mm	73	54	P90445	O95046	1210 g	£82.60





	(mm)	1 (mm)					
940559-C	59 mm	73	54	P90445	O95046	1216 g	£87.00
940560-C	60 mm	73	54	P90445	O95046	1280 g	£87.00
940563-C	63 mm	75	54	P90445	O95046	1300 g	£108.70
940565-C	65 mm	78	54	P90445	O95046	1430 g	£108.70
940570-C	70 mm	83	54	P90445	O95046	1700 g	£132.60



3/4" IMPACT SOCKET DIN AF



	(mm)	1 (mm)					
940122	11/16 in	51	41.4	P90435	O95036	280 g	£19.60
940124	3/4 in	51	41.4	P90435	O95036	290 g	£19.60
940126	13/16 in	51	41.4	P90435	O95036	310 g	£19.90
940128	7/8 in	51	41.4	P90435	O95036	310 g	£19.90
940130	15/16 in	51	41.4	P90435	O95036	320 g	£20.20
940132	1 in	53	41.4	P90435	O95036	340 g	£20.20
940134	1-1/16 in	53	44	P90435	O95036	380 g	£21.20
940136	1-1/8 in	53	44	P90435	O95036	380 g	£21.60
940138	1-3/16 in	53	44	P90435	O95036	390 g	£22.10
940140	1-1/4 in	57	44	P90435	O95036	450 g	£23.10
940142	1-5/16 in	57	44	P90435	O95036	460 g	£23.60
940144	1-3/8 in	57	44	P90435	O95036	480 g	£24.10
940146	1-7/16 in	57	44	P90435	O95036	480 g	£24.70
940148	1-1/2 in	57	44	P90435	O95036	510 g	£24.70
940150	1-9/16 in	58	44	P90435	O95036	560 g	£27.00
940152	1-5/8 in	58	44	P90435	O95036	560 g	£27.70

										
		(mm)	1 (mm)							
940154		1-11/16 in	62	44	P90435	O95036	660 g	£28.90		
940156		1-3/4 in	62	44	P90435	O95036	670 g	£30.00		
940160		1-7/8 in	68	44	P90435	O95036	760 g	£36.30		
940162		1-15/16 in	68	44	P90435	O95036	820 g	£39.70		
940164		2 in	68	44	P90435	O95036	830 g	£39.70		
940166		2-1/16 in	71	54	P90445	O95046	1040 g	£52.40		
940168		2-1/8 in	71	54	P90445	O95046	1110 g	£53.90		
940170		2-3/16 in	71	54	P90445	O95046	1150 g	£57.50		
940172		2-1/4 in	73	54	P90445	O95046	1220 g	£59.10		
940174		2-5/16 in	73	54	P90445	O95046	1250 g	£63.70		
940176		2-3/8 in	73	54	P90445	O95046	1250 g	£66.10		



3/4" DEEP IMPACT SOCKET DIN METRIC



										
		(mm)	1 (mm)							
940619-C		19 mm	95	44	P90435	O95036	595 g	£36.30		
940621-C		21 mm	95	44	P90435	O95036	633 g	£36.40		
940622-C		22 mm	95	44	P90435	O95036	633 g	£36.70		
940623-C		23 mm	95	44	P90435	O95036	633 g	£36.90		
940624-C		24 mm	95	44	P90435	O95036	640 g	£37.00		
940627-C		27 mm	95	44	P90435	O95036	680 g	£37.00		
940630-C		30 mm	95	44	P90435	O95036	720 g	£37.10		
940632-C		32 mm	95	44	P90435	O95036	870 g	£37.10		
940633-C		33 mm	95	44	P90435	O95036	860 g	£37.50		
940634-C		34 mm	95	44	P90435	O95036	810 g	£38.10		
940636-C		36 mm	95	44	P90435	O95036	830 g	£40.80		
940638-C		38 mm	95	44	P90435	O95036	920 g	£43.70		
940641-C		41 mm	95	44	P90435	O95036	790 g	£57.00		
940646-C		46 mm	95	44	P90435	O95036	900 g	£70.30		
940650-C		50 mm	95	44	P90435	O95036	1227 g	£74.40		
940652-C		52 mm	100	54	P90445	O95046	1500 g	£87.00		
940654-C		54 mm	100	54	P90445	O95046	1600 g	£89.10		
940655-C		55 mm	100	54	P90445	O95046	1700 g	£93.50		
940656-C		56 mm	100	54	P90445	O95046	1749 g	£97.80		
940658-C		58 mm	105	54	P90445	O95046	1850 g	£100.00		
940660-C		60 mm	105	54	P90445	O95046	1850 g	£108.70		
940665-C		65 mm	105	54	P90445	O95046	1960 g	£121.70		



SOCKETS & ACCESSORIES



3/4" DEEP IMPACT SOCKET DIN AF



		(mm)	1 (mm)								
940224	3/4 in	90	41.4	P90433	O95034	460 g	£34.30				
940226	13/16 in	90	41.4	P90433	O95034	510 g	£35.40				
940228	7/8 in	90	41.4	P90433	O95034	520 g	£35.40				
940230	15/16 in	90	41.4	P90433	O95034	560 g	£35.60				
940232	1 in	90	41.4	P90433	O95034	590 g	£36.00				
940234	1-1/16 in	90	44	P90435	O95036	630 g	£36.00				
940236	1-1/8 in	90	44	P90435	O95036	650 g	£35.90				
940238	1-3/16 in	90	44	P90435	O95036	680 g	£36.20				
940240	1-1/4 in	90	44	P90435	O95036	730 g	£36.20				
940242	1-5/16 in	90	44	P90435	O95036	760 g	£36.80				
940244	1-3/8 in	90	44	P90435	O95036	810 g	£37.90				
940246	1-7/16 in	90	44	P90435	O95036	810 g	£38.30				
940248	1-1/2 in	90	44	P90435	O95036	870 g	£39.70				
940250	1-9/16 in	90	44	P90435	O95036	930 g	£42.90				
940252	1-5/8 in	90	44	P90435	O95036	950 g	£43.40				
940254	1-11/16 in	90	44	P90435	O95036	1060 g	£47.00				
940256	1-3/4 in	90	44	P90435	O95036	1070 g	£48.60				
940258	1-13/16 in	90	44	P90435	O95036	1090 g	£53.20				
940260	1-7/8 in	90	44	P90435	O95036	1140 g	£57.90				



3/4" EXTRA LONG IMPACT SOCKET METRIC



		(mm)	1 (mm)								
940732-C	32 mm	400	44	P90435	O95036	1660 g	£101.90				



3/4" HEX IMPACT SOCKET DIN METRIC



		(mm)	1 (mm)								
941519-C	19 mm	90	44	P90435	O95036	600 g	£67.60				
941522-C	22 mm	90	44	P90435	O95036	600 g	£68.20				
941524-C	24 mm	90	44	P90435	O95036	600 g	£68.60				



1" IMPACT SOCKET DIN METRIC



910524	24 mm	58	54	P90545	O97045	640 g	£37.60				
910527	27 mm	58	54	P90545	O97045	645 g	£37.60				
910530	30 mm	60	54	P90545	O97045	680 g	£37.60				
910532	32 mm	60	54	P90545	O97045	700 g	£37.60				
910533	33 mm	60	54	P90545	O97045	700 g	£37.60				
910534	34 mm	60	54	P90545	O97045	690 g	£37.60				
910536	36 mm	65	54	P90545	O97045	700 g	£38.00				
910538	38 mm	65	54	P90545	O97045	700 g	£39.60				
910541	41 mm	67	54	P90545	O97045	750 g	£42.50				
910546	46 mm	74	54	P90545	O97045	850 g	£54.90				
910550	50 mm	80	54	P90545	O97045	1005 g	£58.90				
910555	55 mm	84	54	P90545	O97045	1220 g	£73.10				
910560	60 mm	87	54	P90545	O97045	1470 g	£95.10				
910565	65 mm	90	54	P90545	O97045	1610 g	£103.90				
910570	70 mm	96	54	P90545	O97045	1890 g	£120.50				
910575	75 mm	98	60	P90551	O97051	2355 g	£161.10				
910580	80 mm	100	60	P90551	O97051	2455 g	£174.10				
910585	85 mm	100	86	P90675	O910075	3750 g	£189.90				
910590	90 mm	100	86	P90675	O910075	4000 g	£199.50				
910595	95 mm	100	86	P90675	O910075	4600 g	£233.50				



1" DEEP IMPACT SOCKET DIN METRIC



910627R	27 mm	100	54	P90545	O97045	990 g	£56.50				
910630R	30 mm	100	54	P90545	O97045	1040 g	£57.00				
910632R	32 mm	100	54	P90545	O97045	1060 g	£57.50				
910633R	33 mm	100	54	P90545	O97045	1150 g	£58.60				



1" DEEP THINWALL IMPACT SOCKET DIN METRIC



910624	24 mm	100	54	P90545	O97045	830 g	£88.10				
910627	27 mm	100	54	P90545	O97045	895 g	£88.50				
910628	28 mm	100	54	P90545	O97045	900 g	£88.60				
910630	30 mm	100	54	P90545	O97045	940 g	£88.90				
910632	32 mm	100	54	P90545	O97045	935 g	£89.00				
910633	33 mm	100	54	P90545	O97045	980 g	£91.90				
910636	36 mm	100	54	P90545	O97045	990 g	£97.80				



SOCKETS & ACCESSORIES



1" EXTRA LONG IMPACT SOCKET METRIC



Part No.	Length (mm)	Width (mm)	Hex Size (mm)	Material	Weight (g)	Price (£)
910732	32 mm	400	54	P90545	O97045 1840 g	£118.30



1-1/2" IMPACT SOCKET DIN METRIC



Part No.	Length (mm)	Width (mm)	Hex Size (mm)	Material	Weight (g)	Price (£)
912041	41 mm	80	86	P90675	O910075 1800 g	£252.90
912046	46 mm	84	86	P90675	O910075 2000 g	£252.90
912050	50 mm	87	86	P90675	O910075 2400 g	£266.10
912055	55 mm	90	86	P90675	O910075 2600 g	£294.70
912060	60 mm	95	86	P90675	O910075 2870 g	£323.40
912065	65 mm	100	86	P90675	O910075 3230 g	£339.50
912070	70 mm	105	86	P90675	O910075 3670 g	£393.90
912075	75 mm	105	86	P90675	O910075 4000 g	£427.90
912080	80 mm	110	86	P90675	O910075 4300 g	£486.90
912085	85 mm	110	86	P90675	O910075 4600 g	£512.90
912090	90 mm	112	86	P90675	O910075 5100 g	£799.90
912095	95 mm	112	127	P906110	O9100115 7700 g	£1,249.00
912100	100 mm	115	127	P906110	O9100115 8200 g	£1,612.00
912105	105 mm	120	127	P906110	O9100115 8600 g	£1,684.00
912110	110 mm	124	127	P906110	O9100115 9100 g	£1,859.00
912115	115 mm	128	127	P906110	O9100115 10300 g	£1,969.00
912120	120 mm	132	127	P906110	O9100115 11500 g	£2,029.00
912125	125 mm	136	127	P906110	O9100115 12500 g	£2,119.00
912130	130 mm	140	127	P906110	O9100115 13500 g	£2,144.00

TORQUE TOOLS

MAKE THE PROFESSIONAL CHOICE

TengTools torque wrenches have become an industry standard. Whether you choose the classic version that has been a favourite for many years or the new P-Series range designed for the industrial and maintenance sectors you are guaranteed quality, accuracy and reliability as standard.



TORQUE WRENCH

Click type mechanism to signal when the required torque is reached

Equipped with an in-built angular gauge for when tightening at specific angle is required

Reversible 24 teeth ratchet mechanism in according to DIN3122 giving 15° increments

Switch for changing between left and right-hand action. Designed to torque right hand only. Bi-Directional models are available.

Scale in Nm & ft/lb

Twist locking to ensure the set torque is maintained

Accurate to +/- 4% and conforms to ISO6789



TORQUE WRENCH PLUS

Quick release 72 teeth ratchet mechanism with twist reverse manufactured to DIN3122

Compact head for easier use in confined spaces

Click type mechanism to signal when the required torque is reached

Industrial quality grade steel tube for added stability

Ergonomic bi-material grip for maximum comfort when in use

Easy to read Nm scale that is simple to adjust

Locking button to ensure the set torque is securely maintained

Hanging facility which can be used together with a fall protection equipment

Accurate to +/- 4% and conforms to ISO6789



TORQUE TOOLS



1/4" TORQUE SCREWDRIVER



1492TSD	1-5 Nm	0.02 ± 6%	Factory	215	84	225 g	£138.00
1492TSD-CT	1-5 Nm	0.02 ± 6%	New	215	84	225 g	£198.00



1/4" TORQUE WRENCH



1492AG-CT	5-25 Nm	0.1 ± 4%	New	277	580 g		£159.60
1492AG-E	5-25 Nm	0.1 ± 4%	Factory	277	580 g		£99.50



INSULATED TORQUE SCREWDRIVER



1492TVSD	1-5 Nm	0.02 ± 6%	Factory	213	82	222 g	£162.20
1492TVSD-CT	1-5 Nm	0.02 ± 6%	New	213	82	222 g	£222.20



1/4" TORQUE WRENCH PLUS



1492P015	3-15 Nm	0.4 ± 4%	Factory	190	240 g		£144.00
1492P030	6-30 Nm	0.2 ± 4%	Factory	215	267 g		£144.00



3/8" TORQUE WRENCH



3892AG3-CT	20-110 Nm	0.5	± 4%	New	368	844 g	£174.90	
3892AG-E3	20-110 Nm	0.5	± 4%	Factory	360	844 g	£114.90	
3892AG1-CT	5-25 Nm	0.5	± 4%	New	277	606 g	£159.90	
3892AG-E1	5-25 Nm	0.5	± 4%	Factory	277	606 g	£99.90	



3/8" TORQUE WRENCH PLUS



3892P060	12-60 Nm	0.5	± 4%	Factory	380	930 g	£196.90	
3892P060-CT	12-60 Nm	0.5	± 4%	New	380	930 g	£256.90	
3892P100	20-100 Nm	0.5	± 4%	Factory	410	960 g	£206.90	
3892P100-CT	20-100 Nm	0.5	± 4%	New	410	960 g	£266.90	
3892P030	6-30 Nm	0.2	± 4%	Factory	215	272 g	£152.90	



DIGITAL TORQUE WRENCH



3892D100	10-100 Nm	0.1	± 1%	Factory	465	892 g	£629.90	
3892D100-CT	10-100 Nm	0.1	± 1%	New	465	892 g	£689.90	



1/2" TORQUE WRENCH



1292AG-EP	40-210 Nm	1	± 4%	Factory	465	1340 g	£119.90	
1292AGP-CT	40-210 Nm	1	± 4%	New	465	1340 g	£179.90	
1292AG4-CT	70-350 Nm	1	± 4%	New	632	2400 g	£269.90	
1292AG-E4	70-350 Nm	1	± 4%	Factory	632	2400 g	£209.90	



TORQUE TOOLS



1/2" TORQUE WRENCH BI-DIRECTIONAL



1292AG-ER	40-210 Nm	1	± 4%	Factory	465	1340 g	£148.90	
1292AGR-CT	40-210 Nm	1	± 4%	New	465	1340 g	£208.90	
1292AG4R-CT	70-350 Nm	1	± 4%	New	632	2400 g	£296.90	
1292AG-E4R	70-350 Nm	1	± 4%	Factory	632	2400 g	£236.90	



1/2" TORQUE WRENCH PLUS



1292P100	20-100 Nm	0.5	± 4%	Factory	410	965 g	£214.00	
1292P100-CT	20-100 Nm	0.5	± 4%	New	410	965 g	£274.00	
1292P200	40-200 Nm	1	± 4%	Factory	490	1465 g	£222.00	
1292P200-CT	40-200 Nm	1	± 4%	New	490	1465 g	£282.00	
1292P320	60-320 Nm	2	± 4%	Factory	560	1645 g	£334.00	
1292P320-CT	60-320 Nm	2	± 4%	New	560	1645 g	£394.00	



DIGITAL TORQUE WRENCH



1292D200	20-200 Nm	0.1	± 1%	Factory	548	1340 g	£719.90	
1292D200-CT	20-200 Nm	0.1	± 1%	New	548	1340 g	£779.90	



INSERT TORQUE WRENCH 14 X 18



1292P418	40-200 Nm	1	± 4%	Factory	480	1096 g	£246.00	
1292P418-CT	40-200 Nm	1	± 4%	New	480	1096 g	£306.00	



INSERT TORQUE WRENCH 9 X 12



1292P912	20-100 Nm	0.5	± 4%	Factory	400	862 g	£234.00	
1292P912-CT	20-100 Nm	0.5	± 4%	New	400	862 g	£294.00	



3/4" TORQUE WRENCH



3492AG1-CT	140-700 Nm	2.5	± 4%	New	1065	5970 g	£876.00	
3492AG-E1	140-700 Nm	2.5	± 4%	Factory	1065	5970 g	£816.00	
3492AG2-CT	140-980 Nm	3.5	± 4%	New	1213	6550 g	£1,047.00	
3492AG-E2	140-980 Nm	3.5	± 4%	Factory	1213	6550 g	£987.00	
3492AG-CT	65-450 Nm	5	± 4%	New	850	3840 g	£363.00	
3492AG-E	65-450 Nm	5	± 4%	Factory	850	3840 g	£303.00	





3/4" TORQUE WRENCH PLUS



Model	Range (Nm)	Accuracy	Factory	Length (mm)	Weight (g)	Price
3492P500	100-500	± 4%	Factory	790	3100	£499.00
3492P500-CT	100-500	± 4%	New	790	3100	£559.00
3492P1000	200-1000	± 4%	Factory	1243	5900	£1,253.00

3/4" TORQUE WRENCH BI-DIRECTIONAL



Model	Range (Nm)	Accuracy	Factory	Length (mm)	Weight (g)	Price
3492AG-ER	65-450	± 4%	Factory	850	3840	£338.00
3492AGR-CT	65-450	± 4%	New	850	3840	£398.00



Do's and Dont's of Torque Wrenches

DO'S

- **Use carefully:** Torque wrenches are a measuring instrument and need to be treated with care
- **Reset torque:** After use set the torque to its lowest setting. If you don't over time the springs inside the wrench can lose their normal tension
- **Store Safely:** All torque instruments should be stored in their original case
- **Keep wrench maintained:** Torque wrenches should be cleaned and calibrated on a yearly basis

DONT'S

- **Use as a power bar:** Torque wrenches should never be used as a power bar to shift stubborn fastenings
- **Abuse your wrench:** Do not drop your torque wrench or overload the wrench with a pipe extension
- **Store in conditions that lead to corrosion:** Avoid any storage locations that are subject to high or low temperatures and high humidity
- **Use without PPE:** We recommend safety glasses when using any torque wrench or torque product



1" TORQUE WRENCH PLUS 1500/2000 NM



		Nm	%		mm	g	£
1192P1500		300-1500	± 4%	Factory	1754	11550	£1,790.00
1192P2000		400-2000	± 4%	Factory	2215	13350	£2,219.00



1" TORQUE WRENCH PLUS 1000 NM



		Nm	%		mm	g	£
1192P1000		200-1000	± 4%	Factory	1243	6050	£1,299.00



INSERT RATCHET HEAD

		mm	g	£
1292CQ200R		70.5	288	£51.30
3492CQ500R		98	988	£180.90
3892CQ100R		36.3	148	£47.90



OPEN ENDED INSERT SPANNER 9 X 12



		mm	g	£
690510		39	42	£28.00
690511		39	43	£28.00
690512		40	48	£28.00
690513		42	52	£28.90
690514		42	59	£28.90
690515		43	59	£28.90
690516		43	67	£28.90
690517		44	67	£28.90
690518		46	75	£28.90
690519		46	75	£28.90



TORQUE TOOLS





RING ENDED INSERT SPANNER 9 X 12

	 mm		
690710	45	52 g	£27.50
690711	45	50 g	£27.50
690712	46	60 g	£27.50
690713	49	58 g	£28.70
690714	50	64 g	£29.10
690715	50	64 g	£29.10
690716	50	62 g	£29.10
690717	54	74 g	£29.10
690718	54	74 g	£30.30
690719	54	68 g	£30.30





OPEN ENDED INSERT SPANNER 14 X 18

	 mm		
690613	63	148 g	£30.90
690614	63	154 g	£30.90
690615	64	154 g	£30.90
690616	64	173 g	£30.90
690617	64	173 g	£30.90
690618	65	192 g	£30.90
690619	65	193 g	£30.90
690621	66	217 g	£32.70
690622	66	222 g	£32.70
690624	67	217 g	£32.70
690626	70	273 g	£32.70
690627	70	265 g	£32.70
690629	74	312 g	£32.70
690630	74	312 g	£32.70
690632	77	322 g	£32.70
690634	82	345 g	£36.00
690636	82	368 g	£36.00
690638	82	366 g	£36.90
690640	83	383 g	£36.90
690641	84	400 g	£43.90
690642	83	410 g	£43.90
690644	86	423 g	£49.10
690646	86	436 g	£49.10





RING ENDED INSERT SPANNER 14 X 18

	 mm			
690813	72	200 g	£31.20	
690814	72	166 g	£31.20	
690815	73	194 g	£31.20	
690816	73	195 g	£31.20	
690817	73	196 g	£32.20	
690818	75	234 g	£32.30	
690819	75	230 g	£32.30	
690821	76	236 g	£33.70	
690822	77	249 g	£33.70	
690824	78	254 g	£33.70	
690826	78	240 g	£36.00	
690827	82	280 g	£36.00	
690829	85	306 g	£36.00	
690830	87	328 g	£36.00	
690832	87	312 g	£36.00	
690834	90	324 g	£38.70	
690836	91	316 g	£40.00	
690838	94	342 g	£41.40	
690840	93	395 g	£44.50	
690841	99	392 g	£47.40	
690842	99	372 g	£47.40	
690844	99	421 g	£54.80	
690846	103	396 g	£54.80	



3/8" CROW FOOT WRENCH



3/8"

	 mm			
M386510-C	32.3	20 g	£12.50	
M386511-C	34.3	22 g	£12.50	
M386512-C	45.5	24 g	£12.80	
M386513-C	36.2	27 g	£12.80	
M386514-C	37.4	32 g	£12.90	
M386515-C	40	37 g	£13.20	
M386516-C	47.6	37 g	£15.20	
M386517-C	41.3	55 g	£15.20	
M386518-C	41.3	57 g	£16.00	
M386519-C	45.5	61 g	£17.00	



1/2" TORQUE STICK

1/2"

	 mm			
923110	110 Nm	200	211 g	£26.00
923120	120 Nm	200	226 g	£26.00
923140	140 Nm	200	255 g	£26.00
923090	90 Nm	200	206 g	£26.00



TORQUE TOOLS



TORQUE SPANNER SET 4 PIECES



- » Torque Spanner Set 4 Pieces
- » 17 mm 18Nm
- » 22 mm 42 Nm
- » 26 mm 55 Nm
- » 29 mm 65 Nm



ACD01

£509.90



ANGULAR GAUGE



- » For measuring the degree of turn
- » For use when after tightening of stretch bolts with torque wrenches that do not have an in-built angular gauge
- » A static read off point, fixing magnet and a pair of angle scales make it possible to take a reading in most situations



TQAG

£82.90



TORQUE MULTIPLIER 1:3



MP1400	1:3	1/2"	3/4"	1500 Nm	69 mm	2237 g	£628.00
--------	-----	------	------	---------	-------	--------	---------

MP2700	1:3	3/4"	1"	3000 Nm	92 mm	4834 g	£727.00
--------	-----	------	----	---------	-------	--------	---------



TORQUE MULTIPLIER SUPPORT LEG



MPSL01	Torque Multiplier Support Leg MP1400	1209 g	£58.00
--------	--------------------------------------	--------	--------

MPSL02	Torque Multiplier Support Leg MP2700	1581 g	£81.00
--------	--------------------------------------	--------	--------



Recalculate new torque setting if required:

New Torque = P x Ln / Le

- P = Desired Torque
- Ln = Normal Length
- Le = Extended Length



TORQUE MULTIPLIER 1:10

1/2"



MP91500

01:10

1/2"

3/4"

1500 Nm

2079 g

£709.00



TORQUE TESTER STAND



TORQS01

16460 g

£342.00



DIGITAL TORQUE TESTER



TORQ02U

UK

1.5-30 Nm

±1%

Factory

2940 g

£1,539.00

TORQ04U

UK

25-500 Nm

±1%

Factory

4060 g

£1,549.00

TORQ05U

UK

50-1000 Nm

±1%

Factory

4060 g

£1,649.00

TORQ03U

UK

7.5-150 Nm

±1%

Factory

3940 g

£1,539.00



TORQUE TESTER PRINTER AND STAND



TORQU

UK

10 - 400 Nm

20568 g

£3,159.00





Scan the QR code to contact us or request a call back





-
-
-
-
-
-
-
-
-
-
-
-
-
-
-
-
-

SPANNERS & WRENCHES

QUALITY AS STANDARD

Our range has been developed over many years with DIN and ISO standards as the lowest benchmark when it comes to quality and size tolerances. This is a policy that has resulted in many top positions on best-buy lists in consumer and trade magazines. The range includes many different types of spanners for most application areas and personal taste.



COMBINATION SPANNERS

High mechanical performance and optimized for increased accessibility complying with DIN and ISO standards

Manufactured and designed in accordance with DIN3113A in high grade chrome vanadium steel

Size clearly marked on the side of the spanner for easy & quick visibility

The ring head is offset 15° to facilitate use even on flat surfaces

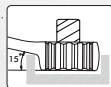

TengTools "Hip Grip" feature means the contact surface grips on the flat surfaces of the nut or bolt rather than on the corner



RATCHETING SPANNERS

'R' range contains a lever to quickly switch between left and right-hand action. With the 'RS' range you flip the spanner over to change ratcheting direction.

'R' range is offset at 15° for use against flat surfaces while the 'RS' range is straight to reach the nut flat



-
-
-
-
-
-
-
-
-
-
-
-
-
-
-
-
-

SPANNERS & WRENCHES



COMBINATION SPANNER METRIC



	mm	mm	mm	mm	mm	mm	g	£
6005055	5.5 mm	95	13.6	3.5	8.9	4.1	11 g	£7.80
600506	6 mm	100	15.5	4.0	10.1	4.7	15 g	£7.80
600507	7 mm	110	17.0	4.0	11.5	5.0	21 g	£7.80
600508	8 mm	120	19.2	4.5	12.8	5.5	26 g	£7.80
600509	9 mm	130	21.2	4.5	14.2	5.9	32 g	£8.00
600510	10 mm	140	23.2	5.0	15.6	6.5	36 g	£8.40
600511	11 mm	150	25.3	5.4	16.9	6.9	43 g	£8.50
600512	12 mm	160	27.2	5.5	18.3	7.3	58 g	£8.70
600513	13 mm	170	29.4	5.9	19.7	7.8	77 g	£9.00
600514	14 mm	180	31.5	6.2	21.2	8.3	84 g	£10.10
600515	15 mm	190	33.2	6.4	22.5	8.6	96 g	£10.30
600516	16 mm	200	34.7	6.7	24.0	8.9	112 g	£11.60
600517	17 mm	210	36.5	6.9	25.3	9.3	123 g	£12.30
600518	18 mm	220	38.7	7.2	26.8	9.9	140 g	£13.70
600519	19 mm	230	40.7	7.4	28.1	10.5	166 g	£14.20
600520	20 mm	240	43.1	7.7	29.7	10.9	180 g	£15.60
600521	21 mm	250	44.8	8.0	31.3	11.3	217 g	£15.90
600522	22 mm	260	46.9	8.2	32.6	11.5	220 g	£17.90
600523	23 mm	270	48.3	8.4	34.2	11.8	230 g	£20.40
600524	24 mm	280	50.4	8.7	35.5	12.1	284 g	£21.30

	mm	mm	mm	mm	mm	mm	g	£
600525	25 mm	290	52.0	8.9	36.9	12.5	313 g	£23.60
600526	26 mm	300	53.6	9.2	38.2	12.8	320 g	£25.10
600527	27 mm	310	55.7	9.4	39.6	13.1	370 g	£27.30
600528	28 mm	320	57.6	9.7	40.9	13.3	415 g	£29.10
600529	29 mm	330	59.7	9.9	42.3	13.5	417 g	£30.40
600530	30 mm	340	61.8	10.1	43.7	13.7	445 g	£31.60
600532	32 mm	360	65.8	10.4	46.4	14.3	550 g	£33.60
600533	33 mm	380	69.2	10.7	48.8	15.0	654 g	£43.80
600534	34 mm	380	69.2	10.7	48.8	15.0	674 g	£45.30
600536	36 mm	410	74.0	13.5	53.5	19.2	831 g	£59.90
600538	38 mm	430	77.0	15.0	56.0	20.4	967 g	£69.80
600541	41 mm	460	84.0	16.0	61.0	21.6	1257 g	£79.20
600546	46 mm	500	92.0	17.0	66.0	23.0	1693 g	£112.90
600550	50 mm	540	102.0	18.0	73.0	24.6	2048 g	£130.90
600555	55 mm	560	118.0	28.0	86.0	21.5	2997 g	£324.00
600558	58 mm	600	126.0	30.0	94.0	23.5	4005 g	£407.00
600560	60 mm	600	126.0	30.0	94.0	23.5	4065 g	£416.00
600565	65 mm	680	148.0	32.0	108.0	25.0	5688 g	£580.00
600570	70 mm	680	148.0	32.0	108.0	25.0	5866 g	£587.00



COMBINATION SPANNER AF



	mm	mm	mm	mm	mm	mm	
600152	1-5/8 in	460	84.0	16.0	61.0	21.6	1309 g £88.50
600116	1/2 in	170	29.4	5.9	19.7	7.8	70 g £9.90
600110	5/16 in	120	19.2	4.5	12.8	5.5	27 g £8.30
600142	1-5/16 in	380	69.2	10.7	48.8	15.0	649 g £48.20
600128	7/8 in	260	46.9	8.2	32.6	11.5	217 g £20.00
600146	1-7/16 in	410	74.0	13.5	53.0	19.2	838 g £67.20
600132	1 in	290	52.0	8.9	36.9	12.5	302 g £27.80
600130	15/16 in	280	50.4	8.7	35.5	12.1	290 g £23.20
600144	1-3/8 in	410	74.0	13.5	53.0	16.2	858 g £51.30
600120	5/8 in	200	34.7	6.7	24.0	8.9	85 g £11.90
600108	1/4 in	100	15.5	4.0	10.1	4.7	18 g £8.30
600156	1-3/4 in	500	92.0	17.0	66.0	23.0	1595 g £135.90
600160	1-7/8 in	540	102.0	18.0	73.0	24.6	2097 g £147.90
600134	1-1/16 in	310	55.7	9.4	39.6	13.1	379 g £30.40
600122	11/16 in	210	36.5	6.9	25.3	9.3	127 g £13.80
600112	3/8 in	140	23.2	5.0	15.6	6.5	40 g £8.40
600126	13/16 in	250	44.8	8.0	31.3	11.3	210 g £17.00
600124	3/4 in	230	40.7	7.4	28.1	10.5	163 g £15.00
600148	1-1/2 in	430	77.0	15.0	56.0	20.4	1002 g £72.50
600118	9/16 in	180	31.5	6.2	21.2	8.3	80 g £10.40
600140	1-1/4 in	360	65.8	10.4	46.4	14.3	553 g £37.60
600114	7/16 in	150	25.3	5.4	16.9	6.9	48 g £8.70
600136	1-1/8 in	330	57.6	9.7	40.9	13.3	455 g £33.00



COMBINATION SPANNER SET 8-19 MM 12 PIECES



	»	8, 9, 10, 11, 12, 13, 14, 15, 16, 17, 18, 19
6512N		£107.50



SPANNERS & WRENCHES



COMBINATION SPANNER SET 6-22 MM 17 PIECES



» 6, 7, 8, 9, 10, 11, 12, 13, 14, 15, 16, 17, 18, 19, 20, 21, 22



6517

£159.30



COMBINATION SPANNER SET 8-19 MM TOOL ROLL 10 PIECES



» 8, 9, 10, 11, 12, 13, 14, 15, 17, 19



6510MM

£93.50



COMBINATION SPANNER SET 8-19 MM TOOL ROLL 12 PIECES



» 8, 9, 10, 11, 12, 13, 14, 15, 16, 17, 18, 19



6512MM1

£111.90



**COMBINATION SPANNER SET 5.5-19 MM TOOL ROLL
15 PIECES**

15 PCS **DIN** 3113A mm CrV

- » 5.5, 6, 7, 8, 9, 10, 11, 12, 13, 14, 15, 16, 17, 18, 19



6515MM £133.50



**COMBINATION SPANNER SET 20-32 MM TOOL ROLL
12 PIECES**

12 PCS **DIN** 3113A mm CrV

- » 20, 21, 22, 23, 24, 25, 26, 27, 28, 29, 30, 32



6512MM £268.90



**COMBINATION SPANNER SET 6-22 MM TOOL ROLL
17 PIECES**

17 PCS **DIN** 3113A mm CrV

- » 6, 7, 8, 9, 10, 11, 12, 13, 14, 15, 16, 17, 18, 19, 20, 21, 22



6517MM £179.90



**COMBINATION SPANNER SET 6-32 MM TOOL ROLL
26 PIECES**

26 PCS **DIN** 3113A mm CrV

- » 6, 7, 8, 9, 10, 11, 12, 13, 14, 15, 16, 17, 18, 19, 20, 21, 22, 23, 24, 25, 26, 27, 28, 29, 30, 32



6526MM £379.90



SPANNERS & WRENCHES



**COMBINATION SPANNER SET 33-50 MM TOOL ROLL
7 PIECES**

7 PCS **DIN** 3113A mm CrV



» 33, 34, 36, 38, 41, 46, 50



6507JMM

£497.70



**COMBINATION SPANNER SET 13/16"-1 1/4" TOOL ROLL
7 PIECES**

7 PCS AF CrV



» 13/16, 7/8, 15/16, 1, 1 1/16, 1 1/8, 1 1/4



6507AF

£169.90



**COMBINATION SPANNER SET 1/4"-3/4" TOOL ROLL
9 PIECES**

9 PCS AF CrV



» 1/4, 5/16, 3/8, 7/16, 1/2, 9/16, 5/8, 11/16, 3/4



6509AF

£92.50



**COMBINATION SPANNER SET 1 5/16"-1 7/8" TOOL ROLL
7 PIECES**

7 PCS AF CrV



» 1 5/16, 1 3/8, 1 7/16, 1 1/2, 1 5/8, 1 3/4, 1 7/8



6507JAF

£497.70



COMBINATION SPANNER ANTI SLIP METRIC



	mm	mm	mm	mm	mm	mm	mm	g	£
800608	8	120	18.9	4.5	12.8	6.6	24	24 g	£9.10
800609	9	130	20.8	4.5	14.2	7.0	28	28 g	£9.30
800610	10	140	22.5	5.0	15.6	7.7	36	36 g	£9.50
800611	11	150	24.5	5.4	16.9	8.4	46	46 g	£9.70
800612	12	160	27.2	5.5	18.0	8.5	58	58 g	£9.90
800613	13	170	29.6	5.9	19.5	8.8	71	71 g	£10.00
800614	14	180	31.1	6.2	21.5	9.6	81	81 g	£11.00
800615	15	185	32.5	6.4	22.8	10.1	93	93 g	£11.70
800616	16	195	35.0	6.5	24.2	10.5	110	110 g	£13.10
800617	17	202	37.0	6.9	25.2	11.0	123	123 g	£13.70
800618	18	208	39.0	7.1	26.8	11.5	135	135 g	£15.00
800619	19	218	41.1	7.5	28.4	12.2	156	156 g	£15.90



**COMBINATION SPANNER SET ANTI SLIP TOOL ROLL
12 PIECES**



	mm	g	£
»	8, 9, 10, 11, 12, 13, 14, 15, 16, 17, 18, 19		
8512MM			£125.90



STUBBY COMBINATION SPANNER METRIC



	mm	mm	mm	mm	mm	mm	g	£	
6005M10	10	95	21.9	5.1	16.2	7.0	30	30 g	£8.00
6005M11	11	100	23.8	5.9	17.9	7.8	42	42 g	£8.70
6005M12	12	105	24.7	6.6	19.1	8.2	48	48 g	£9.50
6005M13	13	110	27.1	6.7	19.3	8.8	55	55 g	£9.60
6005M14	14	115	28.9	7.4	21.8	9.1	66	66 g	£10.10
6005M15	15	120	31.1	7.5	22.6	9.2	71	71 g	£10.80
6005M16	16	125	33.0	8.1	23.6	9.8	87	87 g	£11.60
6005M17	17	130	36.0	8.3	25.9	10.3	105	105 g	£12.90
6005M18	18	135	36.8	8.7	27.2	11.0	118	118 g	£13.80
6005M19	19	140	38.1	9.4	28.7	11.2	130	130 g	£15.00





LONG COMBINATION SPANNER METRIC



	mm	mm	mm	mm	mm	g		
605908	8 mm	148	17.2	4.9	12.6	5.3	36 g	£10.00
605909	9 mm	158	19.4	5.0	13.7	6.2	44 g	£10.00
605911	11 mm	188	23.1	5.6	16.7	7.3	70 g	£10.60
605912	12 mm	198	25.3	6.3	17.7	7.9	78 g	£11.00
605914	14 mm	228	29.8	7.4	21.4	9.0	125 g	£14.00
605915	15 mm	238	32.4	7.6	22.5	9.9	140 g	£15.00
605916	16 mm	246	32.4	8.2	23.5	10.4	164 g	£15.70
605917	17 mm	266	36.0	8.2	25.4	40.5	262 g	£17.80
605919	19 mm	285	39.8	9.1	28.3	12.6	214 g	£19.90



Do's and Dont's of Spanners

DO'S

- **Use the right size spanner** for the job: Make sure you have the correct size spanner for the nut or bolt you are working on.
- **Keep the spanner clean and dry:** Wipe down the spanner after use to prevent rust and corrosion.
- **Apply pressure correctly:** Apply pressure to the spanner in the direction that tightens the nut or bolt.
- **Use the right technique:** Use a firm grip on the spanner and turn it with a smooth motion. Avoid jerking or twisting the spanner, as this can cause damage to both the tool and the fastener.
- **Inspect the spanner regularly:** Check the spanner for any signs of wear or damage. Replace any damaged tools immediately.

DONT'S

- **Use a damaged spanner:** Do not use a spanner that is damaged or worn, as it may slip or break during use.
- **Use a spanner as a hammer:** Do not use a spanner as a hammer or pry bar, as this can damage both the spanner and the object you are working on.
- **Over-tighten nuts and bolts:** Do not over-tighten nuts and bolts with a spanner, as this can cause damage to the fastener and the tool.
- **Use a spanner in wet or oily conditions:** Do not use a spanner in wet or oily conditions, as this can cause the tool to slip and cause injury.



RATCHETING COMBINATION SPANNER METRIC R



600508R	8 mm	140	17.0	4.0	17.0	6.5	30 g	£22.00	
600509R	9 mm	150	19.0	4.4	18.5	6.9	30 g	£21.90	
600510R	10 mm	159	21.0	4.8	20.0	7.3	50 g	£24.00	
600511R	11 mm	165	23.0	5.2	22.0	7.7	70 g	£25.20	
600512R	12 mm	172	25.0	5.5	23.0	8.2	80 g	£27.40	
600513R	13 mm	178	27.0	5.8	25.0	8.5	100 g	£28.10	
600514R	14 mm	191	29.0	6.2	27.0	9.0	120 g	£29.50	
600515R	15 mm	200	31.0	6.5	28.0	9.4	140 g	£30.30	
600516R	16 mm	208	33.0	6.8	30.0	9.9	170 g	£33.20	
600517R	17 mm	226	36.0	7.2	32.0	10.3	200 g	£33.20	
600518R	18 mm	237	38.0	7.7	33.0	10.7	210 g	£35.90	
600519R	19 mm	248	40.0	8.2	34.0	11.2	220 g	£36.50	
600522R	22 mm	290	45.0	9.0	38.4	13.0	360 g	£50.00	
600524R	24 mm	323	52.0	9.8	43.6	14.5	510 g	£59.90	
600527R	27 mm	359	56.0	10.5	52.5	15.5	640 g	£108.90	
600530R	30 mm	403	59.0	11.4	58.5	17.0	880 g	£129.00	
600532R	32 mm	425	63.0	12.5	62.5	17.5	1080 g	£150.00	



RATCHETING COMBINATION SPANNER AF R



600110R	5/16 in	140	16.7	4.6	16.6	6.5	30 g	£27.90	
600112R	3/8 in	159	20.8	5.3	20.0	7.3	50 g	£29.90	
600114R	7/16 in	165	23.0	5.6	21.8	7.7	70 g	£31.90	
600116R	1/2 in	178	27.1	6.4	24.7	8.6	100 g	£35.50	
600118R	9/16 in	191	29.2	6.8	27.0	9.0	120 g	£36.90	
600120R	5/8 in	208	33.4	7.2	30.0	9.9	170 g	£41.90	
600122R	11/16 in	226	35.5	7.7	31.8	10.3	200 g	£42.00	
600124R	3/4 in	248	39.7	8.8	33.8	11.2	220 g	£47.00	
600126R	13/16 in	290	46.0	9.0	40.0	13.0	360 g	£62.50	
600128R	7/8 in	323	46.0	9.0	40.0	13.0	510 g	£62.50	



SPANNERS & WRENCHES



RATCHETING COMBINATION SPANNER SET R TOOL ROLL 8 PIECES



»	
	8, 10, 11, 12, 13, 14, 17, 19
6508RMM	£219.90



RATCHETING COMBINATION SPANNER METRIC RS



	mm	mm	mm	mm	mm	mm	mm	g	
600508RS	8 mm	111	19.6	4.0	17.0	6.8	30 g		£22.40
600509RS	9 mm	123	20.8	4.4	19.0	7.2	41 g		£22.60
600510RS	10 mm	131	22.0	4.8	20.0	7.6	48 g		£23.00
600511RS	11 mm	147	24.2	5.2	21.0	8.0	62 g		£23.60
600512RS	12 mm	155	25.7	5.5	23.0	8.5	78 g		£24.60
600513RS	13 mm	164	27.2	5.8	25.0	8.9	88 g		£25.90
600514RS	14 mm	182	30.8	6.2	27.0	9.3	112 g		£28.80
600515RS	15 mm	192	32.4	6.5	28.0	9.7	123 g		£31.80
600516RS	16 mm	202	34.0	6.8	30.0	10.2	144 g		£33.20
600517RS	17 mm	223	37.7	7.2	32.0	10.6	192 g		£35.00
600518RS	18 mm	234	39.3	7.7	33.0	11.0	207 g		£37.20
600519RS	19 mm	246	40.8	8.2	34.0	11.5	233 g		£38.00
600520RS	20 mm	285	46.0	10.0	42.0	13.0	384 g		£39.90
600521RS	21 mm	285	46.0	10.0	42.0	13.0	384 g		£42.10
600522RS	22 mm	285	46.0	10.0	42.0	13.0	387 g		£43.20
600524RS	24 mm	325	51.5	11.0	47.5	14.5	420 g		£44.90



RATCHETING COMBINATION SPANNER METRIC RF



	mm	mm	mm	mm	mm	mm	g	£
600507RF	7 mm	127	17.6	4.0	17.0	6.8	50 g	£28.00
600508RF	8 mm	127	17.6	4.0	17.0	6.8	50 g	£28.00
600509RF	9 mm	131	19.8	4.4	19.0	7.2	50 g	£28.80
600510RF	10 mm	136	22.0	4.8	20.0	7.6	60 g	£30.20
600511RF	11 mm	141	24.1	5.2	21.0	8.0	60 g	£32.00
600512RF	12 mm	147	25.9	5.5	23.0	8.5	80 g	£34.30
600513RF	13 mm	154	27.3	5.8	25.0	9.0	100 g	£35.10
600514RF	14 mm	160	30.6	6.2	27.0	9.3	120 g	£37.60
600515RF	15 mm	169	32.2	6.5	28.0	9.7	120 g	£37.20
600517RF	17 mm	190	36.6	7.2	32.0	10.6	190 g	£40.30
600518RF	18 mm	203	38.4	7.7	33.0	11.0	190 g	£42.60
600519RF	19 mm	215	40.2	8.2	34.0	11.5	200 g	£43.90



STUBBY RATCHETING COMBINATION SPANNER METRIC RS



	mm	mm	mm	mm	mm	mm	g	£
6005M10RS	10 mm	97	22.0	4.8	20.0	7.6	36 g	£20.80
6005M11RS	11 mm	102	24.2	5.2	21.0	8.0	47 g	£21.00
6005M12RS	12 mm	106	25.7	5.5	23.0	8.5	49 g	£22.10
6005M13RS	13 mm	110	27.2	5.8	25.0	8.9	61 g	£23.20
6005M14RS	14 mm	115	30.8	6.2	27.0	9.3	75 g	£23.90
6005M15RS	15 mm	119	32.4	6.5	28.0	9.7	95 g	£24.60
6005M16RS	16 mm	123	34.0	6.8	30.0	10.2	105 g	£25.60
6005M17RS	17 mm	127	37.7	7.2	32.0	10.6	120 g	£27.30
6005M18RS	18 mm	132	39.3	7.7	33.0	11.0	136 g	£28.10
6005M19RS	19 mm	139	40.8	8.2	34.0	11.5	150 g	£29.70







SPANNERS & WRENCHES



DOUBLE RING SPANNER METRIC







						
		mm	mm	mm	g	£
630607	6 × 7 mm	168	10.7 - 12.2	5.6 - 6.3	44 g	£11.30
630809	8 × 9 mm	183	13.6 - 15.1	6.6 - 7.0	67 g	£11.60
631011	10 × 11 mm	198	16.6 - 18.0	7.4 - 7.7	84 g	£12.60
631213	12 × 13 mm	217	19.5 - 20.9	8.1 - 8.4	133 g	£13.50
631415	14 × 15 mm	239	22.4 - 23.7	8.8 - 9.1	154 g	£15.40
631617	16 × 17 mm	260	25.3 - 26.7	9.5 - 9.8	204 g	£15.80
631819	18 × 19 mm	292	28.2 - 29.7	10.1 - 10.4	255 g	£18.40
632022	20 × 22 mm	318	31.1 - 34.0	10.9 - 11.4	308 g	£23.30
632123	21 × 23 mm	326.5	32.6 - 35.5	11.2 - 11.6	383 g	£26.10
632427	24 × 27 mm	329	36.9 - 41.0	12.4 - 13.4	464 g	£29.50
633032	30 × 32 mm	362	45.5 - 48.5	14.4 - 15.2	627 g	£37.40



DOUBLE RING SPANNER RIGGER JIGGER 10 X 13MM







						
		mm	mm	mm	g	£
601013	10 × 13 mm	115.8	15.5 - 17.9	8.0 - 8.0	49 g	£13.90



DOUBLE RING SPANNER AF







						
		mm	mm	mm	g	£
673032	1/4 × 5/16 in	168	10.7 - 12.2	5.6 - 6.3	45 g	£12.10
673436	3/8 × 7/16 in	198	16.6 - 18.0	7.4 - 7.7	93 g	£13.20
673840	1/2 × 7/16 in	217	19.5 - 20.9	8.1 - 7.7	135 g	£14.40
674244	13/16 × 7/8 in	318	31.1 - 34.0	10.9 - 11.4	325 g	£23.10
674648	15/16 × 1-1/16 in	347	36.9 - 40.5	12.4 - 13.4	475 g	£29.20
675052	1 × 1-1/8 in	355	38.4 - 42.8	12.7 - 13.7	570 g	£36.00
675456	1-1/8 × 1-1/4 in	362	45.5 - 48.5	14.4 - 15.2	650 g	£37.30



LONG DOUBLE RING SPANNER METRIC



						
		mm	mm	mm	g	£
630810FL	8 × 10 mm	265	12.5 - 15.0	7.5 - 8.4	76 g	£31.20
631113FL	11 × 13 mm	328	17.8 - 20.3	10.4 - 11.3	143 g	£40.00
631214FL	12 × 14 mm	328	17.8 - 20.3	10.4 - 11.3	172 g	£40.30
631618FL	16 × 18 mm	408	23.4 - 26.3	12.8 - 14.4	280 g	£50.40
631719FL	17 × 19 mm	407	23.7 - 26.6	13.0 - 14.8	290 g	£51.40
632224FL	22 × 24 mm	430	31.3 - 34.0	15.4 - 17.7	436 g	£67.30



DOUBLE RING SPANNER SET TOOL ROLL 8 PIECES

8 PCS **DIN** 838 mm

» 6×7, 8×9, 10×11, 12×13, 14×15, 16×17, 18×19, 20×22



6308MM

£115.50



DOUBLE RING SPANNER SET AF TOOL ROLL 7 PIECES

7 PCS **DIN** 838 AF

» 1/4×5/16, 3/8×7/16, 1/2×7/16, 13/16×7/8, 15/16×1 1/16, 1×1 1/8, 1 1/8×1 1/4



6707AF

£166.90

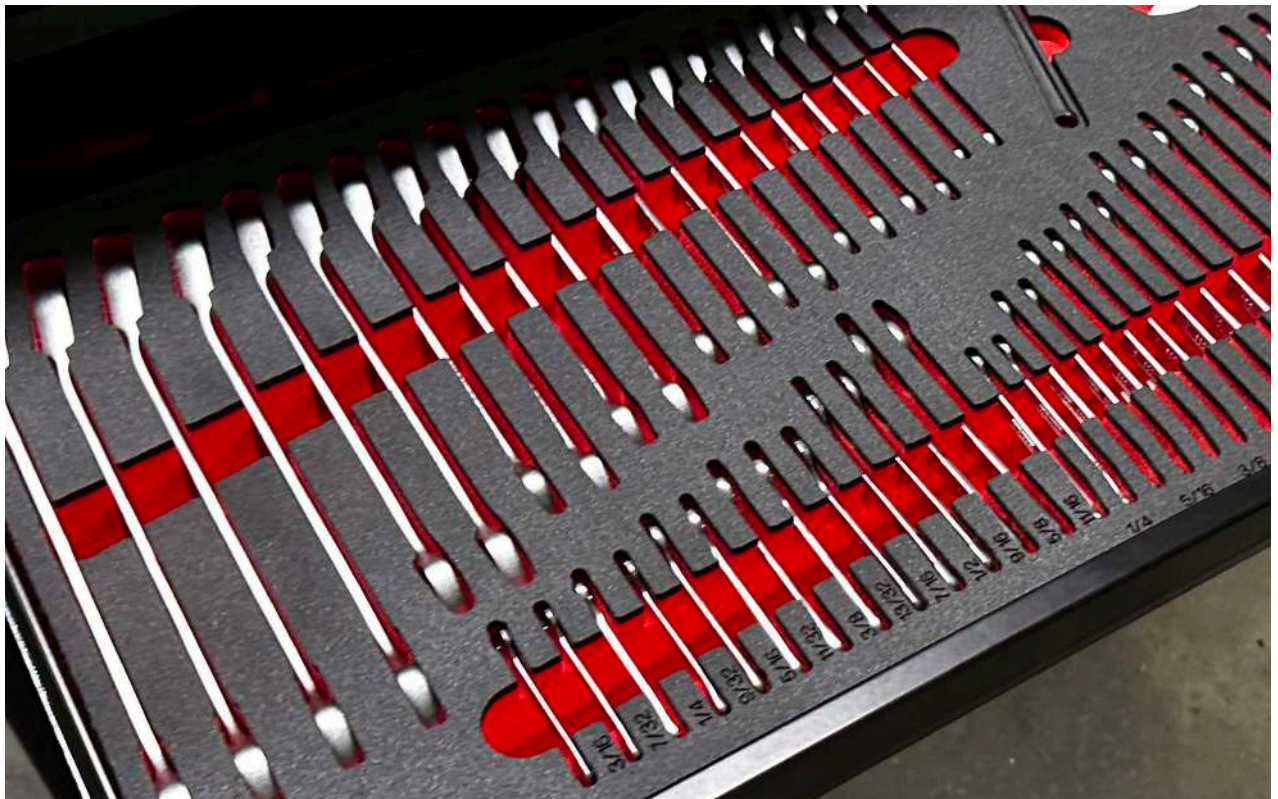

SPANNERS & WRENCHES



SPANNER RING

600	110 mm	60 g	£8.30



DOUBLE OPEN ENDED SPANNER METRIC



	mm	mm	mm	mm		
620607	6 × 7 in	123	15,5;18,0	3,7;3,7	24 g	£6,00
620809	8 × 9 in	140	20,4;22,7	4,0;4,0	42 g	£6,40
621011	10 × 11 in	156	24,9;27,1	5,0;5,0	56 g	£7,80
621213	12 × 13 in	172	29,2;31,2	5,5;5,5	81 g	£8,70
621415	14 × 15 in	188,5	33,3;35,3	5,9;5,9	108 g	£9,00
621617	16 × 17 in	204	37,1;38,9	6,3;6,3	126 g	£10,00
621819	18 × 19 in	221	40,9;42,8	6,7;9,7	178 g	£12,10
622022	20 × 22 in	237	44,8;48,8	7,1;7,1	232 g	£15,20
622123	21 × 23 in	247	46,8;50,8	7,7;7,7	268 g	£17,20
622427	24 × 27 in	263	52,8;59,1	8,1;8,1	333 g	£26,00
623032	30 × 32 in	298	65,4;69,8	9,0;9,0	489 g	£28,30



DOUBLE OPEN ENDED SPANNER AF



	mm	mm	mm	mm		
663032	1/4 × 5/16 in	123	15,5;18,0	2,9;2,9	25 g	£7,40
663436	3/8 × 7/16 in	156	24,9;27,1	3,4;3,4	61 g	£10,10
663840	1/2 × 9/16 in	180	31,3;33,3	4,0;4,0	85 g	£11,10
664244	5/8 × 3/4 in	221	37,1;42,8	4,6;4,6	160 g	£14,10
664648	13/16 × 7/8 in	237	44,8;48,8	4,9;4,9	220 g	£15,50
665052	15/16 × 1 in	255	50,8;56,8	5,3;5,3	298 g	£26,00
665456	1-1/8 × 1-1/4 in	298	65,4;69,8	6,0;6,0	470 g	£33,00



DOUBLE OPEN ENDED SPANNER SET TOOL ROLL 11 PIECES



»		6×7, 8×9, 10×11, 12×13, 14×15, 16×17, 18×19, 20×22, 21×23, 24×27, 30×32
	6211MM	£164.90



DOUBLE FLEX WRENCH METRIC



		mm		
650809	8 × 9 mm	192	99 g	£25.40
651011	10 × 11 mm	200	106 g	£27.90
651013	10 × 13 mm	213	171 g	£29.90
651213	12 × 13 mm	218	169 g	£32.10
651415	14 × 15 mm	243	233 g	£35.50
651617	16 × 17 mm	275	326 g	£37.90
651819	18 × 19 mm	284	423 g	£42.70





SPANNERS & WRENCHES



DOUBLE FLEX WRENCH AF





		 mm		
611214	3/8 × 7/16 in	200	110 g	£26.20
611618	1/2 × 9/16 in	218	179 g	£31.80
612022	5/8 × 11/16 in	275	323 g	£38.10



FLARE NUT WRENCH METRIC





		 mm	 mm		
641011	10 × 11 mm	21.4;23.0	7.9;7.9	60 g	£11.80
641213	12 × 13 mm	25.0;27.4	10.0;10.0	115 g	£13.00
641314	13 × 14 mm	25.0;27.4	13.1;13.1	118 g	£15.00
641617	16 × 17 mm	29.9;31.9	15.1;15.1	163 g	£17.00
641922	19 × 22 mm	34.2;38.2	17.0;17.0	223 g	£18.90



BI-FLEX WRENCH





		 mm		
691406	1/4 × 1/4 in	196	110 g	£34.00



FLARE NUT WRENCH AF



		 mm	 mm		
661416	7/16 × 1/2 in	23.0;24.3	11.9;11.9	77 g	£10.30



RATCHETING MULTI DRIVE RING SPANNER



60051619RX	16 × 17;18 × 19 mm	320	31.7 - 34.0	288 g	£78.10



RATCHETING OFFSET TX-E RING SPANNER



680810E	E8 × E10	133	21.0 - 23.0	8.2 - 8.2	81 g	£24.30
681416E	E14 × E16	172	30.0 - 32.0	10.2 - 10.2	169 g	£30.50
681820E	E18 × E20	103	37.0 - 40.0	11.5 - 11.5	281 g	£33.50



RATCHETING OFFSET RING SPANNER METRIC



680608	6 × 8 mm	112	20.0 - 20.0	8.0 - 8.0	69 g	£14.90
680709	7 × 9 mm	133	21.0 - 23.0	8.4 - 8.4	75 g	£19.60
681013	10 × 13 mm	163	26.0 - 30.0	10.2 - 10.2	149 g	£22.80
681214	12 × 14 mm	172	30.0 - 32.0	10.2 - 10.2	156 g	£23.80
681719	17 × 19 mm	203	37.0 - 40.0	11.0 - 11.0	239 g	£27.80
682122	21 × 22 mm	235	41.0 - 45.0	11.4 - 11.4	281 g	£32.10



RATCHETING CONSTRUCTION WRENCH



PGW1719	17 × 19 mm	315	474 g	£54.50
PGW1922	19 × 22 mm	315	463 g	£54.50
PGW1924	19 × 24 mm	450	469 g	£54.70
PGW2124	21 × 24 mm	315	460 g	£61.70
PGW2430	24 × 30 mm	366	1332 g	£88.90
PGW2730	27 × 30 mm	315	1328 g	£93.90



SPANNERS & WRENCHES



QUICK WRENCH

	mm	mm	mm	mm	g	£
600813	13 mm	141	27.5	7.2	92 g	£45.70
600814	14 mm	191	35.7	10.0	178 g	£56.30
600816	16 mm	191	35.7	10.0	173 g	£56.90
600817	17 mm	191	35.7	10.0	174 g	£57.90
600822	22 mm	233	40.7	13.0	297 g	£68.90
600824	24 mm	235	43.2	13.0	308 g	£79.90
600827	27 mm	325	54.2	14.1	616 g	£106.70
600830	30 mm	325	56.4	15.9	620 g	£109.00



HOOK WRENCH

	af	mm	mm	g	£
HP101	3/4"-1-1/4"	19-50 mm	145	140 g	£33.10
HP102	1-1/4"-3"	32-75 mm	178	246 g	£50.30
HP103	2"-4-3/4"	50-120 mm	247	462 g	£62.00



PIN WRENCH



	mm	mm	g	£	
HP2014	4 mm	19-50 mm	145	139 g	£43.90
HP2015	5 mm	19-50 mm	145	139 g	£43.90
HP2025	5 mm	32-75 mm	178	248 g	£58.70
HP2026	6 mm	32-75 mm	178	231 g	£59.30
HP2036	6 mm	50-120 mm	247	462 g	£67.90
HP2038	8 mm	50-120 mm	247	457 g	£67.90



TELESCOPIC BASIN TAP WRENCH

	mm	mm	g	£
BWT406	32-48 mm	275	803 g	£37.20



RING END SLOGGING WRENCH METRIC



	mm	mm	mm	mm	g	
903024	24 mm	162	42.8	14.7	248 g	£35.60
903027	27 mm	180	45.5	17.0	260 g	£39.50
903030	30 mm	190	52.5	17.5	376 g	£46.20
903032	32 mm	190	52.5	17.5	480 g	£50.30
903036	36 mm	205	58.3	20.0	520 g	£58.40
903038	38 mm	229	63.9	20.0	660 g	£66.50
903041	41 mm	230	63.7	20.0	780 g	£72.70
903046	46 mm	240	73.0	23.0	1150 g	£90.20
903050	50 mm	255	87.5	25.0	1170 g	£95.70
903055	55 mm	266	78.5	25.0	1350 g	£110.80
903060	60 mm	280	91.3	26.4	1650 g	£126.40
903065	65 mm	297	100.3	27.0	1890 g	£154.30
903070	70 mm	328	109.5	34.5	2850 g	£213.20
903075	75 mm	328	109.5	34.5	3020 g	£216.40
903080	80 mm	340	129.3	37.0	3400 g	£452.70
903085	85 mm	340	129.3	37.0	4100 g	£519.90
903090	90 mm	390	144.0	38.8	5200 g	£644.90
903095	95 mm	390	144.0	38.8	5200 g	£695.30
903100	100 mm	420	154.0	42.4	6700 g	£814.90



OPEN END SLOGGING WRENCH METRIC







	mm	mm	mm	mm	g	
902024	24 mm	170	47.2	15.5	250 g	£36.20
902027	27 mm	180	53.5	17.3	350 g	£36.50
902030	30 mm	190	60.2	18.4	500 g	£44.00
902032	32 mm	190	60.2	18.4	500 g	£45.90
902036	36 mm	215	72.3	18.9	700 g	£58.50
902038	38 mm	215	72.3	18.9	750 g	£66.60
902041	41 mm	235	83.4	22.0	900 g	£73.90
902046	46 mm	255	94.0	21.0	1300 g	£94.20
902050	50 mm	299	113.0	27.1	1500 g	£128.90
902055	55 mm	299	113.0	27.1	1950 g	£138.90
902060	60 mm	338	134.8	32.7	2500 g	£202.90
902065	65 mm	338	134.8	32.7	3300 g	£214.90
902070	70 mm	367	148.9	36.0	4300 g	£263.90
902075	75 mm	367	148.9	36.0	4700 g	£272.90
902080	80 mm	400	175.0	33.0	5200 g	£525.90
902085	85 mm	400	175.0	33.0	5500 g	£630.90
902090	90 mm	450	197.0	38.0	7000 g	£689.90
902095	95 mm	450	197.0	38.0	7600 g	£848.90
902100	100 mm	485	215.0	46.0	10500 g	£977.90



SPANNERS & WRENCHES







QUICK SET PLIERS WRENCH

	 mm	 mm	 mm		
MB483-10	45	250	35	422 g	£71.30
MB483-7	37	180	25	223 g	£57.00









ALUMINIUM PIPE WRENCH

	 af	 mm	 mm		
PWC12	1-11/16"	43	300	670 g	£51.00
PWC14	1-31/32"	50	350	860 g	£64.00
PWC18	2-23/64"	60	450	1390 g	£88.00
PWC24	3"	76	600	2220 g	£136.00
PWC36	4-1/64"	102	900	4030 g	£280.00



ADJUSTABLE WRENCH







	 af	 mm	 mm	 mm	 mm		
4001	11/16"	17	100	31.0	14	56 g	£23.20
4002	15/16"	24	150	44.0	19	133 g	£24.30
4003	1-1/8"	28	200	57.0	26	237 g	£29.10
4004	1-1/4"	33	250	68.0	31	430 g	£36.20
4005	1-1/2"	38	300	80.0	32	673 g	£45.50
4006	1-5/16"	50	375	100.0	44	1185 g	£91.90
4007	2-3/8"	60	450	122.0	53	1635 g	£149.90
4008	2-3/4"	80	600	144.0	62	3009 g	£325.90



ADJUSTABLE WRENCH ALLIGATOR



	 af	 mm	 mm	 mm	 mm		
4003J	1-1/4"	33	200	68.0	29	239 g	£47.30



ADJUSTABLE WRENCH TPR GRIP



	af	mm	mm	mm	mm		
4002IQ	15/16"	24	157	52.0	20	123 g	£29.80
4003IQ	1-1/8"	28	206	62.0	25.3	244 g	£35.50
4004IQ	1-1/4"	33	255	72.0	29.5	399 g	£44.10
4005IQ	1-1/2"	38	305	83.0	32.2	673 g	£54.50
4006IQ	1-15/16"	50	380	108.0	44.7	1173 g	£112.90



ADJUSTABLE WRENCH WIDE JAW



	af	mm	mm	mm	mm		
4002WT	1-3/8"	34	172	63.5	30	155 g	£41.90
4003WT	1-1/2"	38	221	72.1	34.1	277 g	£46.20
4004WT	2"	50	275	92.1	41	506 g	£63.60
4005WT	2-3/8"	60	317	110.5	55.7	834 g	£100.50



SCREWDRIVERS

MORE COMFORT MORE POWER

Unlike other brands the TengTools screwdriver blade has steel alloy wings that the plastic handle is moulded around. This allows for greater torque to be put on the screwdriver, ensures the blade is dead straight and stops the blade from moving in the handle.

Size and tip marked at the bottom of each handle for easy identification

Hole in the handle can be used in a fall arrest system, for storage and for use as a T-handle

The bi-material handle is designed for increased comfort and smooth action preventing blisters after continuous use. It gives better support and increased power transfer.

The soft black material prevents the screwdriver from sticking in the hand allowing for rapid movement

The red resistant plastic is used for the core and ensures the blade is held securely

Size marked on shaft for identification while in use

Shaft made from TengTools TT-MV PLUS steel alloy for greater strength and material flexibility

Magnetic tip designed to maximise torque transfer and reduce wear

Designed and manufactured to DIN and ISO industrial standards



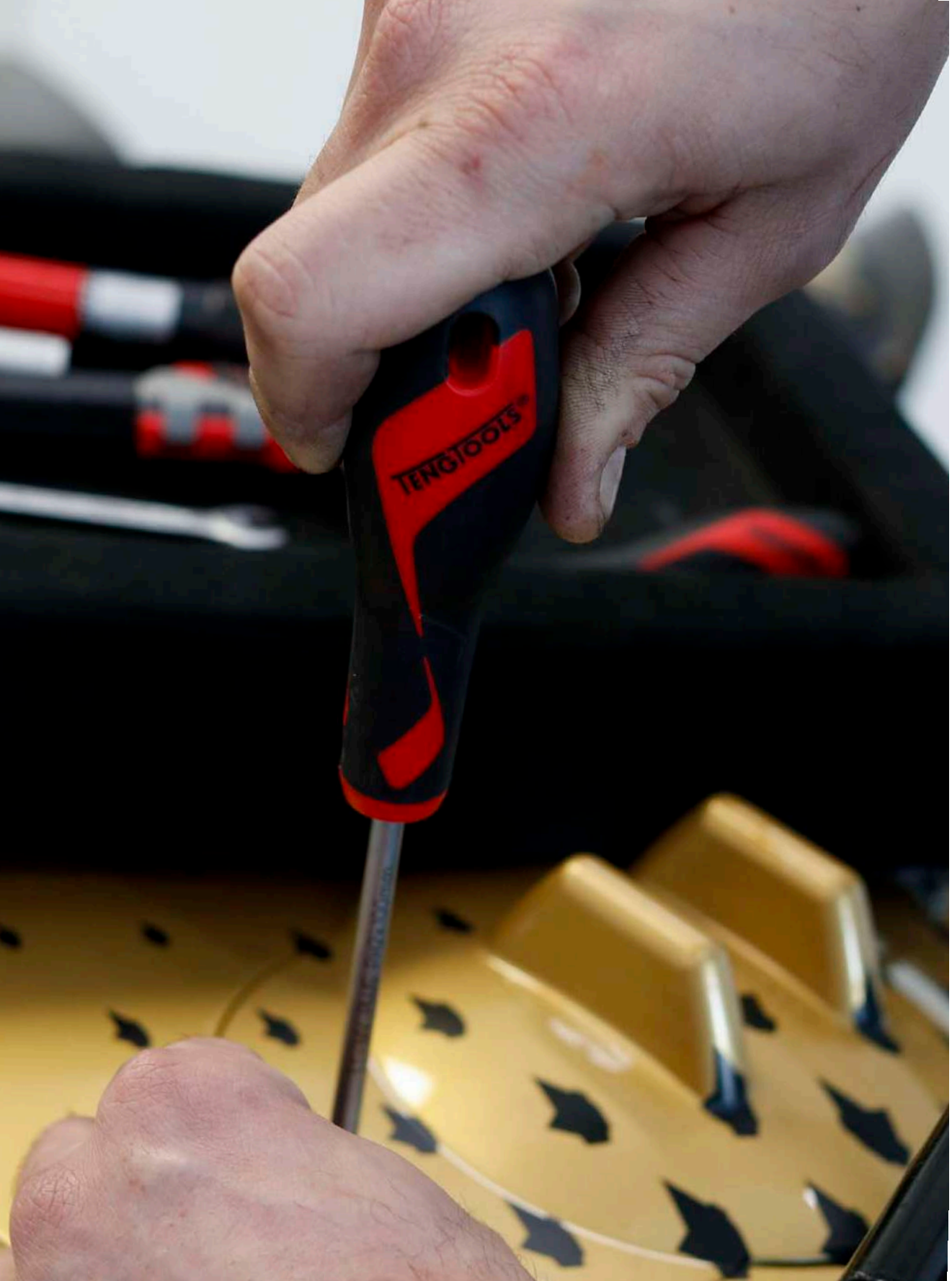

SCREWDRIVERS



FLAT MINI SCREWDRIVER



MDM713	2 mm		122 mm	40 mm	20 g	£6.40
MDM714	2.4 mm		122 mm	40 mm	20 g	£6.40
MDM715	3 mm		122 mm	40 mm	20 g	£6.40



TX MINI SCREWDRIVER



MDM809	TX9		122 mm	40 mm	13 g	£7.70
MDM807	TX7		122 mm	40 mm	12 g	£7.70
MDM810	TX10		122 mm	40 mm	13 g	£7.70
MDM815	TX15		122 mm	40 mm	16 g	£7.70
MDM806	TX6		122 mm	40 mm	12 g	£7.70
MDM808	TX8		122 mm	40 mm	12 g	£7.70



PH MINI SCREWDRIVER



MDM716	PH00		122 mm	40 mm	20 g	£6.40
MDM717	PH0		122 mm	40 mm	20 g	£6.40
MDM718	PH1		122 mm	40 mm	24 g	£6.40



HEX MINI SCREWDRIVER



MDM711	2 mm		122 mm	40 mm	24 g	£6.40
MDM712	2.5 mm		122 mm	40 mm	24 g	£6.40



MINI SCREWDRIVER SET FLAT & PH 6 PIECES



- » Mini Screwdriver Set Flat & PH 6 Pieces
- » Flat Mini Screwdriver 2, 2.4, 3
- » PH Mini Screwdriver PH00, PH0, PH1



MDM706 £30.30



MINI SCREWDRIVER HANDLE



MDM700



112 mm



26 g

£11.00



DOUBLE ENDED MINI SCREWDRIVER BLADE



2912513

3;PH0



120 mm



11 g

£7.70

2912520

PZ0;PZ1



120 mm

11 g

£7.70

2912537

TX6;TX8



120 mm

11 g

£7.70

2912514

4;PH1



120 mm

11 g

£7.70

2912512

2;PH00



120 mm

11 g

£7.70

2912535

TX5;TX7



120 mm

11 g

£7.70

2912539

TX9;TX10



120 mm

11 g

£7.70



MINI SCREWDRIVER SET MIXED 8 PIECES



- » Mini Screwdriver Set Mixed 8 Pieces
- » Double Ended Mini Screwdriver Blade 2;PH00, 3;PH0, 4;PH1, PZ0;PZ1, TX5;TX7, TX6;TX8, TX9;TX10
- » Mini Screwdriver Handle



TM708 £43.70



SCREWDRIVERS



MINI TX T-HANDLE SCREWDRIVER SET 6 PIECES



- » Mini TX T-Handle Screwdriver Set 6 Pieces
- » Mini TX Key
- » TX6, TX7, TX8, TX9, TX10, TX15



MDM706TXT

£32.50



MINI SCREWDRIVER SET TX 6 PIECES



- » Mini Screwdriver Set TX 6 Pieces
- » TX Mini Screwdriver
- » TX6, TX7, TX8, TX9, TX10, TX15



MDM706TX

£30.90



MINI TX KEY



Model	Key	Key Type	Length	Width	Weight	Price
MDM807T	TX7	○	95 mm	50 mm	10 g	£7.40
MDM809T	TX9	○	95 mm	50 mm	13 g	£7.40
MDM808T	TX8	○	95 mm	50 mm	9 g	£7.40
MDM810T	TX10	○	95 mm	50 mm	13 g	£7.40
MDM806T	TX6	○	95 mm	50 mm	9 g	£7.50
MDM815T	TX15	○	95 mm	50 mm	13 g	£7.40



PH MINI SCREWDRIVER POCKET CLIP



Model	Key	Key Type	Length	Width	Weight	Price
MDMC715N	PH1	○	120 mm	50 mm	13 g	£7.00



CHOOSE THE RIGHT HANDLE FOR THE RIGHT TASK

A larger type of handle allows for more power and force to be executed with the driver while a smaller type of handle make it easier to work quickly as less force is required with the driver.

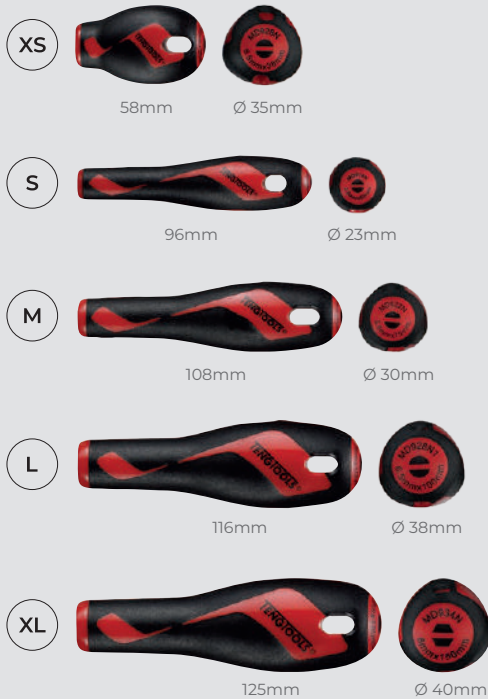

FLAT SCREWDRIVER



			(mm)					
MD914N	0.4 × 2.5 mm		146	50 mm	25 g	S	S	£5.80
MD915N	0.5 × 2.5 mm		171	75 mm	26 g	S	S	£5.80
MD916N	0.6 × 3.5 mm		171	75 mm	30 g	S	S	£6.50
MD916N1	0.6 × 3.5 mm		196	100 mm	32 g	S	S	£7.00
MD916N2	0.6 × 3.5 mm		246	150 mm	35 g	S	S	£7.50
MD917N	0.8 × 4.0 mm		196	100 mm	36 g	S	S	£7.00
MD917N2	0.8 × 4.0 mm		246	150 mm	40 g	S	S	£7.80
MD920N	0.5 × 3.0 mm		171	75 mm	26 g	S	S	£6.50
MD920N1	0.5 × 3.0 mm		196	100 mm	29 g	S	S	£7.00
MD922N	1.0 × 5.5 mm		183	75 mm	57 g	M	S	£8.90
MD923N	1.0 × 5.5 mm		258	150 mm	69 g	M	S	£9.30
MD928N	1.2 × 6.5 mm		96	38 mm	47 g	XS	S	£7.90
MD928N1	1.2 × 6.5 mm		216	100 mm	98 g	L	S	£10.70
MD928N2	1.2 × 6.5 mm		266	150 mm	108 g	L	S	£11.20
MD928N3	1.2 × 6.5 mm		316	200 mm	117 g	L	S	£12.00
MD928N4	1.2 × 6.5 mm		208	100 mm	77 g	M	S	£10.00
MD928N5	1.2 × 6.5 mm		258	150 mm	89 g	M	S	£11.00
MD928N6	1.2 × 6.5 mm		308	200 mm	100 g	M	S	£12.00
MD930N	1.6 × 10.0 mm		325	200 mm	231 g	XL	S	£18.10
MD931N	1.0 × 5.5 mm		241	125 mm	65 g	L	S	£10.00
MD932N	1.2 × 6.5 mm		216	100 mm	105 g	L	S	£10.90
MD932N1	1.2 × 6.5 mm		266	150 mm	117 g	L	S	£11.90
MD934N	1.2 × 8.0 mm		275	150 mm	159 g	XL	S	£15.10
MD935N	1.6 × 10.0 mm		325	200 mm	231 g	XL	S	£18.40



SCREWDRIVERS



PH SCREWDRIVER



			(mm)				
MD940N	PH0		171	75 mm	28 g	S	£6.40
MD940N1	PH0		396	300 mm	40 g	S	£8.90
MD947N	PH1		96	38 mm	40 g	XS	£8.00
MD947N1	PH1		183	75 mm	55 g	M	£8.40
MD948N	PH2		96	38 mm	47 g	XS	£8.00
MD948N1	PH2		216	100 mm	98 g	L	£10.70
MD948N2	PH2		316	200 mm	120 g	L	£12.40
MD948N4	PH2		208	100 mm	71 g	M	£10.50
MD948N5	PH2		308	200 mm	92 g	M	£11.80
MD948N6	PH2		508	400 mm	135 g	M	£16.80
MD948N8	PH2		408	300 mm	115 g	M	£13.90
MD949N	PH3		275	150 mm	155 g	XL	£14.60
MD950N	PH4		325	200 mm	234 g	XL	£18.10
MD952N	PH2		216	100 mm	101 g	L	£11.30
MD952N1	PH2		516	400 mm	181 g	L	£26.80
MD953N	PH3		275	150 mm	160 g	XL	£15.00
MD954N	PH4		325	200 mm	233 g	XL	£18.30

PZ SCREWDRIVER



			(mm)				
MD960N	PZ0		171	75 mm	28 g	S	£6.50
MD961N	PZ1		183	75 mm	29 g	M	£8.40
MD961N1	PZ1		358	250 mm	75 g	M	£10.60
MD961N2	PZ1		96	38 mm	41 g	XS	£8.20
MD962N	PZ2		216	100 mm	100 g	L	£10.70
MD962N1	PZ2		266	150 mm	109 g	L	£11.00
MD962N2	PZ2		216	100 mm	105 g	L	£10.80
MD962N3	PZ2		96	38 mm	47 g	XS	£8.00
MD962N4	PZ2		208	100 mm	71 g	M	£10.60
MD962N4A	PZ2		308	200 mm	93 g	M	£11.50
MD962N5	PZ2		258	150 mm	82 g	M	£10.70
MD963N	PZ3		275	150 mm	161 g	XL	£15.10
MD964N	PZ4		325	200 mm	233 g	XL	£18.60



Do's and Don'ts of Screwdrivers

DO'S

- Use the right tip
- Keep it clean & dry
- Apply extra torque correctly
- Choose the right handle

DONT'S

- Do not use the wrong tip
- Do not use the screwdriver as a lever
- Do not use on live electrics
- Do not use too much power



TX SCREWDRIVER



Model	Bit	Tip (mm)	Length (mm)	Weight (g)	Material		Price
MD906TN	TX6	171	75 mm	32 g	S		£7.00
MD907TN	TX7	171	75 mm	33 g	S		£7.00
MD908TN	TX8	171	75 mm	33 g	S		£7.00
MD909TN	TX9	171	75 mm	33 g	S		£7.00
MD910TN	TX10	208	100 mm	61 g	M		£9.00
MD915TN	TX15	208	100 mm	61 g	M		£9.20
MD920TN	TX20	208	100 mm	61 g	M		£9.20
MD925TN	TX25	216	100 mm	98 g	L		£11.20
MD927TN	TX27	216	100 mm	100 g	L		£11.20
MD930TN	TX30	216	100 mm	99 g	L		£11.30
MD940TN	TX40	216	100 mm	110 g	L		£11.30
MD945TN	TX45	237	125 mm	145 g	XL		£15.60



HEX SCREWDRIVER



Model	Bit	Tip (mm)	Length (mm)	Weight (g)	Material		Price
MD7020HN	2 mm	196	100 mm	27 g	S		£6.10
MD7030HN	3 mm	196	100 mm	31 g	S		£6.30



TPX SCREWDRIVER



Model	Bit	Tip (mm)	Length (mm)	Weight (g)	Material		Price
MD610TPN	TPX10	208	100 mm	61 g	M		£9.30
MD615TPN	TPX15	208	100 mm	61 g	M		£9.30
MD620TPN	TPX20	208	100 mm	61 g	M		£9.30
MD625TPN	TPX25	216	100 mm	97 g	L		£11.50
MD627TPN	TPX27	216	100 mm	96 g	L		£11.50
MD630TPN	TPX30	216	100 mm	99 g	L		£11.50
MD640TPN	TPX40	216	100 mm	108 g	L		£11.50



BALL POINT HEX SCREWDRIVER



Model	Bit	Tip (mm)	Length (mm)	Weight (g)	Material		Price
MD7020HBN	2 mm	196	100 mm	26 g	S		£6.30
MD7025HBN	2.5 mm	196	100 mm	29 g	S		£6.30
MD7030HBN	3 mm	246	150 mm	36 g	S		£7.00
MD7040HBN	4 mm	258	150 mm	68 g	M		£7.80
MD7050HBN	5 mm	266	150 mm	108 g	L		£9.30
MD7060HBN	6 mm	266	150 mm	123 g	L		£12.10
MD7080HBN	8 mm	275	150 mm	192 g	XL		£16.40



SCREWDRIVERS



ROB SCREWDRIVER



Model	Bit	Length (mm)	Length (mm)	Weight (g)	Length (mm)	Weight (g)	Price (£)
MD801N	ROB1		216	100 mm	98 g	L	£10.30
MD802N	ROB2		216	100 mm	97 g	L	£10.40
MD803N	ROB3		216	100 mm	94 g	L	£10.40



DOUBLE ENDED SCREWDRIVER BLADE

Model	Bit	Length (mm)	Weight (g)	Price (£)
HBH0303	3,3 Ballpoint	175 mm	43 g	£10.80
PZZ0102	PZ1;PZ2	175 mm	44 g	£9.90
TXX3040	TX30;TX40	175 mm	45 g	£9.90
TXX1015	TX10;TX15	175 mm	43 g	£9.90
HBH0404	4,4 Ballpoint	175 mm	43 g	£10.80
FTF4055	0.8 x 4,1.0 x 5.5 mm	175 mm	43 g	£9.90
TXX2025	TX20;TX25	175 mm	43 g	£9.90
PHF0365	1.2 x 6.5;PH3 mm	175 mm	44 g	£9.90
PHH0102	PH1;PH2	175 mm	43 g	£9.90
MD901	Handle	130 mm	77 g	£13.30
HBH0606	6,6 Ballpoint	175 mm	45 g	£10.80
HBH0505	5,5 Ballpoint	175 mm	45 g	£10.80



FLAT POWER THROUGH SCREWDRIVER



Model	Bit	Length (mm)	Length (mm)	Weight (g)	Length (mm)	Weight (g)	Price (£)
MDT932N	1.2 x 6.5 mm		216	100 mm	136 g	L	£12.00
MDT934N	1.2 x 8 mm		275	150 mm	215 g	XL	£17.00
MDT935N	1.6 x 10 mm		325	200 mm	279 g	XL	£19.30



PH POWER THROUGH SCREWDRIVER



Model	Bit	Length (mm)	Length (mm)	Weight (g)	Length (mm)	Weight (g)	Price (£)
MDT952N	PH2		216	100 mm	136 g	L	£12.00
MDT953N	PH3		275	150 mm	218 g	XL	£17.00



NUT DRIVER

CrV



MDN505	5 mm	237 mm	125 mm	91 g	£15.40
MDN5055	5.5 mm	237 mm	125 mm	93 g	£15.50
MDN506	6 mm	237 mm	125 mm	93 g	£15.60
MDN507	7 mm	237 mm	125 mm	98 g	£15.80
MDN508	8 mm	237 mm	125 mm	102 g	£16.40
MDN510	10 mm	241 mm	125 mm	130 g	£16.70
MDN511	11 mm	241 mm	125 mm	153 g	£17.30
MDN512	12 mm	241 mm	125 mm	153 g	£18.00
MDN513	13 mm	241 mm	125 mm	160 g	£18.50



MAGNETIC SCREWDRIVER CHARGER

- » Magnetic screwdriver charger and discharger
- » Use to magnetise or demagnetise screwdrivers
- » Supplied on a handy key ring



MR500	£11.70
-------	--------



T HANDLE NUT DRIVER

CrV



MDNT405	5 mm	288 mm	230 mm	107 g	£16.20
MDNT4055	5.5 mm	288 mm	230 mm	131 g	£16.20
MDNT406	6 mm	288 mm	230 mm	130 g	£16.20
MDNT409	9 mm	288 mm	230 mm	143 g	£18.90
MDNT411	11 mm	288 mm	230 mm	184 g	£20.60
MDNT412	12 mm	288 mm	230 mm	187 g	£21.50
MDNT413	13 mm	288 mm	230 mm	186 g	£22.00
MDNT414	14 mm	288 mm	230 mm	202 g	£23.70



SCREWDRIVERS



SCREWDRIVER SET MIXED 54 PIECES



- » Screwdriver Set Mixed 53 Pieces
- » 1/4" Hex Bits 25 mm
 - » 2, 3, 4, 5, 6, 8
- » Flat Screwdriver
 - » 0.5×3.0 (×2), 0.8×4.0, 1.0×5.5 (×2), 1.2×6.5 (×3), 1.2×8.0, 1.6×10.0
- » PH Screwdriver
 - » PH0, PH1, PH2 (×2), PH3
- » PZ Screwdriver
 - » PZ1, PZ2 (×2), PZ3
- » 1/4" Ratcheting Bits Driver Set
 - » 1/4" Flat Bits 25 mm
 - » 1.0×5.5, 1.4×7.0
 - » Hex Socket Adaptor 1/4" Hex - 1/4" 25 mm
 - » 1/4" PH Bits 25 mm
 - » PH1, PH2
 - » 1/4" PZ Bits 25 mm
 - » PZ1, PZ2
 - » 1/4" PZ Bits 25 mm
 - » PZ0
 - » 1/4" ROB Bits 25 mm
 - » 1, 2, 3
 - » 1/4" TPX Bits 25 mm
 - » TPX20, TPX25, TPX30
 - » 1/4" TX Bits 25 mm
 - » TX6, TX7, TX8, TX9, TX10, TX15, TX20 (×2), TX25 (×2), TX27, TX30, TX40



MD9053N

£236.90



SCREWDRIVER SET MIXED 10 PIECES



- » Screwdriver Set Mixed 10 Pieces
- » Flat Screwdriver
 - » 0.5×3.0, 1.0×5.5 (×2), 1.2×6.5
- » PH Screwdriver
 - » PH0, PH1, PH2
- » PZ Screwdriver
 - » PZ1, PZ2
- » Flat Insulated Screwdriver 0.5 × 3.0 mm



MD910N

£99.90



SCREWDRIVER SET MIXED 11 PIECES



- » Screwdriver Set Mixed 11 Pieces
- » Flat Screwdriver
 - » 0.5×3.0, 1.0×5.5 (×2), 1.2×6.5 (×2)
- » PH Screwdriver
 - » PH0, PH1, PH2 (×2)
- » PZ Screwdriver
 - » PZ1, PZ2



MD911N

£101.90



SCREWDRIVER SET MIXED 6 PIECES



- » Screwdriver Set Mixed 6 Pieces
- » Flat Screwdriver
 - » 0.6×3.5, 1.0×5.5
- » PH Screwdriver
 - » PH1, PH2
- » PZ Screwdriver
 - » PZ1, PZ2



MD906N

£54.90



SCREWDRIVER SET FLAT & PH 6 PIECES



- » Screwdriver Set Flat & PH 6 Pieces
- » Flat Screwdriver
 - » 0.5×3.0, 0.8×4.0, 1.0×5.5, 1.2×6.5
- » PH Screwdriver
 - » PH1, PH2



MD906N3

£54.90



SCREWDRIVERS



SCREWDRIVER SET MIXED 12 PIECES



- » Screwdriver Set Mixed 12 Pieces
- » Flat Screwdriver
 - » 0.5×2.5, 0.6×3.5, 0.8×4.0, 1.0×5.5, 1.2×6.5, 1.6×10.0
- » PH Screwdriver
 - » PH0, PH1, PH2 (×2)
- » PZ Screwdriver
 - » PZ1, PZ2



MD912N

£105.90

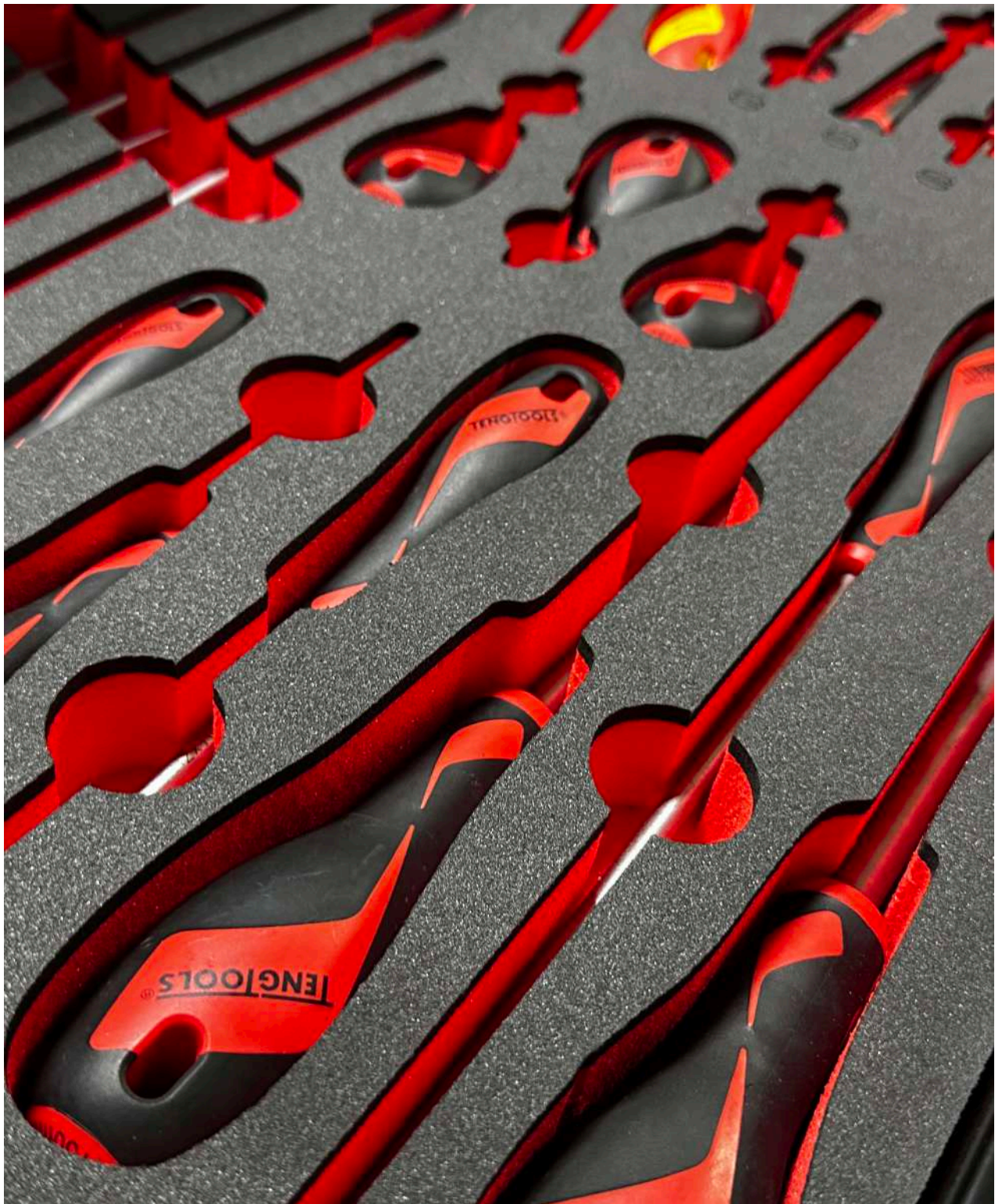

BITS & DRIVERS

QUALITY YOU CAN TRUST

All TengTools bits with a hexagonal drive are designed and manufactured in accordance with the latest industrial standards. Screwdriver bits and socket bits are classified as consumables and thus are only guaranteed to meet dimensional standards.

An extensive range of bit drivers are available in the range including ratcheting drivers, stubby drivers and folding handle drivers for greater power transfer. A selection of drivers offer the option of storing bits in the handle so you do not have to waste time searching for bits when you need them.



Bit sets supplied in handy pocket sized storage with bits that are easy to access. More belt clip sets have been added to the range to help you keep small tool sets in arms reach at all times.





BITS & DRIVERS



1/4" DOUBLE ENDED FLAT BITS



FTF32406005	0.8 x 4, 1.0 x 6 mm	1/4" Hex	5	32	£7.70	



1/4" FLAT BITS 25MM



FL2506A03	0.6 x 3.5 mm	1/4" Hex	3	25	£5.30	
FL2506B03	0.6 x 4.5 mm	1/4" Hex	3	25	£5.30	
FL2508A03	0.8 x 4.0 mm	1/4" Hex	3	25	£5.30	
FL2508B03	0.8 x 5.5 mm	1/4" Hex	3	25	£5.30	
FL2510A03	1.0 x 5.5 mm	1/4" Hex	3	25	£5.30	
FL2512A03	1.2 x 6.5 mm	1/4" Hex	3	25	£5.30	
FL2516A03	1.6 x 8.0 mm	1/4" Hex	3	25	£7.00	



1/4" FLAT BITS 50MM



FL5006A03	0.6 x 3.5 mm	1/4" Hex	3	50	£7.00	
FL5008A03	0.8 x 4.0 mm	1/4" Hex	3	50	£7.00	
FL5008B03	0.8 x 5.5 mm	1/4" Hex	3	50	£7.00	
FL5010A03	1.0 x 5.5 mm	1/4" Hex	3	50	£7.00	
FL5012A03	1.2 x 6.5 mm	1/4" Hex	3	50	£7.00	



1/4" FLAT BITS 70MM



FL7006A02	0.6 x 3.5 mm	1/4" Hex	2	70	£7.00	
FL7008A02	0.8 x 4.0 mm	1/4" Hex	2	70	£7.00	
FL7008B02	0.8 x 5.5 mm	1/4" Hex	2	70	£7.00	
FL7010A02	1.0 x 5.5 mm	1/4" Hex	2	70	£7.00	



1/4" FLAT BITS 89MM



		mm			
FL8905A01	0.5 x 3.0 mm	1/4" Hex	1	89	£7.00
FL8908A01	0.8 x 4.0 mm	1/4" Hex	1	89	£7.00



1/4" DOUBLE ENDED PH BITS



		mm			
PHH32000305	PH0, PH3	1/4" Hex	5	32	£7.70
PHH32010205	PH1, PH2	1/4" Hex	5	32	£7.70



5/16" FLAT IMPACT DRIVER BITS



		mm			
940006	6 mm	5/16" Hex	1	36	£6.20
940008	8 mm	5/16" Hex	1	37	£6.20
940010	10 mm	5/16" Hex	1	38	£6.60
940012	12 mm	5/16" Hex	1	39	£6.80



1/4" PH BITS 25MM



		mm			
PH2500103	PH1	1/4" Hex	3	25	£5.20
PH2500110	PH1	1/4" Hex	10	25	£10.10
PH2500203	PH2	1/4" Hex	3	25	£5.20
PH2500210	PH2	1/4" Hex	10	25	£10.10
PH2500303	PH3	1/4" Hex	3	25	£5.20
PH2500310	PH3	1/4" Hex	10	25	£10.10





1/4" PH BITS 50MM



Part No.	Tip	Size	Pkts	Length (mm)	Price
PH5000103	PH1	1/4" Hex	3	50	£6.90
PH5000203	PH2	1/4" Hex	3	50	£6.90
PH5000303	PH3	1/4" Hex	3	50	£6.90



1/4" PH BITS 70MM



Part No.	Tip	Size	Pkts	Length (mm)	Price
PH7000102	PH1	1/4" Hex	2	70	£6.90
PH7000202	PH2	1/4" Hex	2	70	£6.90



1/4" PH BITS 89MM



Part No.	Tip	Size	Pkts	Length (mm)	Price
PH8900101	PH1	1/4" Hex	1	89	£7.00
PH8900201	PH2	1/4" Hex	1	89	£7.00



1/4" PH IMPACT BITS 30MM



				mm	
PHP3000101	PH1	1/4" Hex	1	30	£3.30
PHP3000105	PH1	1/4" Hex	5	30	£11.10
PHP3000201	PH2	1/4" Hex	1	30	£3.30
PHP3000205	PH2	1/4" Hex	5	30	£11.10
PHP3000301	PH3	1/4" Hex	1	30	£3.30
PHP3000305	PH3	1/4" Hex	5	30	£11.10



1/4" PH IMPACT BITS 30MM



				mm	
PHP5000101	PH1	1/4" Hex	1	50	£3.70
PHP5000201	PH2	1/4" Hex	1	50	£3.70
PHP5000301	PH3	1/4" Hex	1	50	£3.70



1/4" PH IMPACT BITS 89MM



				mm	
PHP8900201	PH2	1/4" Hex	1	89	£7.00



5/16" PH IMPACT DRIVER BITS



				mm	
930001	PH1	5/16" Hex	1	40	£6.20
930002	PH2	5/16" Hex	1	41	£6.20
930003	PH3	5/16" Hex	1	42	£6.20
930004	PH4	5/16" Hex	1	43	£6.20



BITS & DRIVERS



1/4" PH G BITS 25MM



				mm		
GR25002010	PH2G	1/4" Hex	10	25	£12.80	
GR25002100	PH2G	1/4" Hex	100	25	£79.90	



1/4" PH G IMPACT BITS 30MM



				mm		
GRP3000201	PH2G	1/4" Hex	1	30	£3.30	
GRP3000205	PH2G	1/4" Hex	5	30	£10.50	



1/4" PH G IMPACT BITS 30MM



				mm		
GRP5000201	PH2G	1/4" Hex	1	50	£3.40	



1/4" DOUBLE ENDED PZ BITS



				mm		
PZZ32000305	PZ0, PZ3	1/4" Hex	5	32	£7.70	
PZZ32010205	PZ1, PZ2	1/4" Hex	5	32	£7.90	



1/4" PZ BITS 25MM



					mm	
PZ2500103	PZ1	1/4" Hex	3	25	£5.00	
PZ2500110	PZ1	1/4" Hex	10	25	£9.60	
PZ2500203	PZ2	1/4" Hex	3	25	£5.00	
PZ2500210	PZ2	1/4" Hex	10	25	£9.60	
PZ2500303	PZ3	1/4" Hex	3	25	£5.00	
PZ2500310	PZ3	1/4" Hex	10	25	£9.60	



1/4" PZ BITS 50MM



					mm	
PZ5000103	PZ1	1/4" Hex	3	50	£7.00	
PZ5000203	PZ2	1/4" Hex	3	50	£7.00	
PZ5000303	PZ3	1/4" Hex	3	50	£7.00	



1/4" PZ BITS 70MM



					mm	
PZ7000102	PZ1	1/4" Hex	2	70	£7.00	
PZ7000202	PZ2	1/4" Hex	2	70	£7.00	



BITS & DRIVERS



1/4" PZ BITS 89MM



					mm	
PZB900101	PZ1	1/4" Hex	1	89		£7.30
PZB900201	PZ2	1/4" Hex	1	89		£7.30



1/4" PZ IMPACT BITS 30MM



					mm	
PZP3000101	PZ1	1/4" Hex	1	30		£3.30
PZP3000105	PZ1	1/4" Hex	5	30		£11.10
PZP3000201	PZ2	1/4" Hex	1	30		£3.30
PZP3000205	PZ2	1/4" Hex	5	30		£11.10
PZP3000301	PZ3	1/4" Hex	1	30		£3.30
PZP3000305	PZ3	1/4" Hex	5	30		£11.10



1/4" PZ IMPACT BITS 50MM



					mm	
PZP5000101	PZ1	1/4" Hex	1	50		£3.90
PZP5000201	PZ2	1/4" Hex	1	50		£3.90
PZP5000301	PZ3	1/4" Hex	1	50		£3.90



1/4" PZ IMPACT BITS 89MM



					mm	
PZP8900201	PZ2	1/4" Hex	1	89		£7.00



5/16" PZ IMPACT DRIVER BITS



					mm	
920001	PZ1	5/16" Hex	1	36	£6.20	
920002	PZ2	5/16" Hex	1	36	£6.20	
920003	PZ3	5/16" Hex	1	36	£6.20	



1/4" DOUBLE ENDED TX BITS



					mm	
TXX32101505	TX10, TX15	1/4" Hex	5	32	£8.10	
TXX32202505	TX20, 25	1/4" Hex	5	32	£8.10	



1/4" TX BITS 25MM



					mm	
TX2500603	TX6	1/4" Hex	3	25	£5.50	
TX2500703	TX7	1/4" Hex	3	25	£5.50	
TX2500803	TX8	1/4" Hex	3	25	£5.50	
TX2500903	TX9	1/4" Hex	3	25	£5.50	
TX2501003	TX10	1/4" Hex	3	25	£5.50	
TX2501503	TX15	1/4" Hex	3	25	£5.50	
TX2502003	TX20	1/4" Hex	3	25	£5.50	
TX2502503	TX25	1/4" Hex	3	25	£5.50	
TX2502703	TX27	1/4" Hex	3	25	£5.50	
TX2503003	TX30	1/4" Hex	3	25	£5.50	
TX2504003	TX40	1/4" Hex	3	25	£5.50	



BITS & DRIVERS



1/4" TX BITS 50MM



TX5000803	TX8	1/4" Hex	3	50	£6.90
TX5001003	TX10	1/4" Hex	3	50	£6.90
TX5001503	TX15	1/4" Hex	3	50	£6.90
TX5002003	TX20	1/4" Hex	3	50	£6.90
TX5002503	TX25	1/4" Hex	3	50	£6.90
TX5002703	TX27	1/4" Hex	3	50	£6.90
TX5003003	TX30	1/4" Hex	3	50	£6.90



1/4" TX BITS 89MM



TX8901001	TX10	1/4" Hex	1	89	£7.00
TX8902001	TX20	1/4" Hex	1	89	£7.00
TX8902501	TX25	1/4" Hex	1	89	£7.00
TX8903001	TX30	1/4" Hex	1	89	£7.00



1/4" TX BITS 70MM



TX7001002	TX10	1/4" Hex	2	70	£6.90
TX7001502	TX15	1/4" Hex	2	70	£6.90
TX7002002	TX20	1/4" Hex	2	70	£6.90
TX7002502	TX25	1/4" Hex	2	70	£6.90



1/4" TX IMPACT BITS 30MM



TXP3001001	TX10	1/4" Hex	1	30	£3.60
TXP3001005	TX10	1/4" Hex	5	30	£11.10
TXP3001501	TX15	1/4" Hex	1	30	£3.60
TXP3001505	TX15	1/4" Hex	5	30	£11.10
TXP3002001	TX20	1/4" Hex	1	30	£3.60
TXP3002005	TX20	1/4" Hex	5	30	£11.10
TXP3002501	TX25	1/4" Hex	1	30	£3.60
TXP3002505	TX25	1/4" Hex	5	30	£11.10
TXP3002701	TX27	1/4" Hex	1	30	£3.60
TXP3002705	TX27	1/4" Hex	5	30	£11.10
TXP3003001	TX30	1/4" Hex	1	30	£3.60
TXP3003005	TX30	1/4" Hex	5	30	£11.10
TXP3004001	TX40	1/4" Hex	1	30	£3.60
TXP3004005	TX40	1/4" Hex	5	30	£11.10



1/4" TX IMPACT BITS 50MM



TXP5001001	TX10	1/4" Hex	1	50	£4.00
TXP5001501	TX15	1/4" Hex	1	50	£4.00
TXP5002001	TX20	1/4" Hex	1	50	£4.00
TXP5002501	TX25	1/4" Hex	1	50	£4.00
TXP5002701	TX27	1/4" Hex	1	50	£4.00
TXP5003001	TX30	1/4" Hex	1	50	£4.00
TXP5004001	TX40	1/4" Hex	1	50	£4.00



1/4" TX IMPACT BITS 89MM



TXP8902001	TX20	1/4" Hex	1	89	£7.60
TXP8902501	TX25	1/4" Hex	1	89	£7.60
TXP8903001	TX30	1/4" Hex	1	89	£7.60



5/16" TX IMPACT DRIVER BITS



970030	TX30	5/16" Hex	1	36	£6.30
970040	TX40	5/16" Hex	1	36	£6.30
970045	TX45	5/16" Hex	1	36	£6.30
970050	TX50	5/16" Hex	1	36	£6.30
970055	TX55	5/16" Hex	1	36	£6.80





TX BITS 40MM



				mm	
220720	TX20	10mm Hex	1	40	£6.00
220725	TX25	10mm Hex	1	40	£6.00
220727	TX27	10mm Hex	1	40	£6.00
220730	TX30	10mm Hex	1	40	£6.00
220740	TX40	10mm Hex	1	40	£6.00
220745	TX45	10mm Hex	1	40	£6.00
220750	TX50	10mm Hex	1	40	£6.00
220755	TX55	10mm Hex	1	40	£6.00
220760	TX60	12mm Hex	1	40	£6.90
220770	TX70	12mm Hex	1	40	£9.00

TX BITS 75MM



				mm	
220820	TX20	10mm Hex	1	75	£8.40
220825	TX25	10mm Hex	1	75	£8.40
220827	TX27	10mm Hex	1	75	£8.40
220830	TX30	10mm Hex	1	75	£8.40
220840	TX40	10mm Hex	1	75	£8.40
220845	TX45	10mm Hex	1	75	£8.40
220850	TX50	10mm Hex	1	75	£8.40
220855	TX55	10mm Hex	1	75	£8.40
220860	TX60	12mm Hex	1	75	£9.00
220870	TX70	12mm Hex	1	75	£12.70



1/4" TPX BITS 25MM



TPX2501003	TPX10	1/4" Hex	3	25	£6.00
TPX2501503	TPX15	1/4" Hex	3	25	£6.00
TPX2502003	TPX20	1/4" Hex	3	25	£6.00
TPX2502503	TPX25	1/4" Hex	3	25	£6.00
TPX2502703	TPX27	1/4" Hex	3	25	£6.00
TPX2503003	TPX30	1/4" Hex	3	25	£6.00
TPX2504003	TPX40	1/4" Hex	3	25	£6.00



1/4" HEX BITS 25MM



HEX2500203	2 mm	1/4" Hex	3	25	£5.60
HEX2500303	3 mm	1/4" Hex	3	25	£5.60
HEX2500403	4 mm	1/4" Hex	3	25	£5.60
HEX2500503	5 mm	1/4" Hex	3	25	£5.60
HEX2500603	6 mm	1/4" Hex	3	25	£5.60
HEX2500803	8 mm	1/4" Hex	3	25	£7.00



1/4" HEX BITS 50MM



HEX5000403	4 mm	1/4" Hex	3	50	£7.00
HEX5000503	5 mm	1/4" Hex	3	50	£7.00
HEX5000603	6 mm	1/4" Hex	3	50	£7.00
HEX5000803	8 mm	1/4" Hex	3	50	£10.40



BITS & DRIVERS



1/4" HEX BITS 89MM



Part Number	Size	Hex	Quantity	Length (mm)	Price
HEX8900401	4 mm	1/4" Hex	1	89	£7.40



1/4" HEX IMPACT BITS 30MM



Part Number	Size	Hex	Quantity	Length (mm)	Price
HEXP3000301	3 mm	1/4" Hex	1	30	£3.20
HEXP3000305	3 mm	1/4" Hex	5	30	£10.70
HEXP3000401	4 mm	1/4" Hex	1	30	£3.20
HEXP3000405	4 mm	1/4" Hex	5	30	£10.70
HEXP3000501	5 mm	1/4" Hex	1	30	£3.20
HEXP3000505	5 mm	1/4" Hex	5	30	£10.70
HEXP3000601	6 mm	1/4" Hex	1	30	£3.20
HEXP3000605	6 mm	1/4" Hex	5	30	£10.70



1/4" HEX IMPACT BITS 50MM



Part Number	Size	Hex	Quantity	Length (mm)	Price
HEXP5000301	3 mm	1/4" Hex	1	50	£3.80
HEXP5000401	4 mm	1/4" Hex	1	50	£3.80
HEXP5000501	5 mm	1/4" Hex	1	50	£3.80
HEXP5000601	6 mm	1/4" Hex	1	50	£3.80



HEX BITS 40MM



	mm			mm	
210705	5 mm	10mm Hex	1	40	£6.00
210706	6 mm	10mm Hex	1	40	£6.00
210707	7 mm	10mm Hex	1	40	£6.00
210708	8 mm	10mm Hex	1	40	£6.00
210709	9 mm	10mm Hex	1	40	£6.00
210710	10 mm	10mm Hex	1	40	£6.00
210712	12 mm	12mm Hex	1	40	£6.50
210714	14 mm	12mm Hex	1	40	£8.10
210717	17 mm	12mm Hex	1	40	£10.00
210719	19 mm	12mm Hex	1	40	£12.00



5/16" HEX IMPACT DRIVER BITS



	mm			mm	
910504	4 mm	5/16" Hex	1	44	£6.20
910505	5 mm	5/16" Hex	1	45	£6.20
910506	6 mm	5/16" Hex	1	46	£6.20
910508	8 mm	5/16" Hex	1	47	£6.20
910510	10 mm	5/16" Hex	1	36	£6.20



HEX BITS 75MM



	mm			mm	
210805	5 mm	10mm Hex	1	75	£8.40
210806	6 mm	10mm Hex	1	75	£8.40
210807	7 mm	10mm Hex	1	75	£8.40
210808	8 mm	10mm Hex	1	75	£8.40
210809	9 mm	10mm Hex	1	75	£8.40
210810	10 mm	10mm Hex	1	75	£8.40
210812	12 mm	12mm Hex	1	75	£8.90
210814	14 mm	12mm Hex	1	75	£11.60
210817	17 mm	12mm Hex	1	75	£15.40
210819	19 mm	12mm Hex	1	75	£17.90



1/4" ROB BITS 25MM



				mm	
ROB2500103	1	1/4" Hex	3	25	£5.60
ROB2500203	2	1/4" Hex	3	25	£5.60
ROB2500303	3	1/4" Hex	3	25	£5.60



BITS & DRIVERS



1/4" ROB IMPACT BITS 30MM



				mm	
ROBP3000101	1	1/4" Hex	1	30	£3.30
ROBP3000105	1	1/4" Hex	5	30	£11.00
ROBP3000201	2	1/4" Hex	1	30	£3.30
ROBP3000205	2	1/4" Hex	5	30	£11.00



1/4" ROB IMPACT BITS 50MM



				mm	
ROBP5000101	1	1/4" Hex	1	50	£3.80
ROBP5000201	2	1/4" Hex	1	50	£3.80
ROBP5000301	3	1/4" Hex	1	50	£3.80



1/4" ROB IMPACT BITS 89MM



				mm	
ROBP8900101	1	1/4" Hex	1	89	£7.00
ROBP8900201	2	1/4" Hex	1	89	£7.00
ROBP8900301	3	1/4" Hex	1	89	£7.00



1/4" MAGNETIC BITS 25MM



				mm	
M140025M		1/4" Hex	1	25	£3.90



1/4" NUT SETTER



NS45108M	1/4 in	Magnet	1/4"	45	£9.00
NS45506M	6 mm	Magnet	1/4"	46	£9.00
NS45507M	7 mm	Magnet	1/4"	49	£9.50
NS45508M	8 mm	Magnet	1/4"	47	£9.50
NS45508R	8 mm	Ring	1/4"	48	£9.50



1/4" IMPACT NUT SETTER

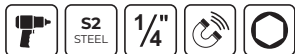

NSP65108	1/4 in	Magnet	1/4"	65	£7.80
NSP65507	7 mm	Magnet	1/4"	65	£8.80
NSP65508	8 mm	Magnet	1/4"	65	£7.70
NSP65510	10 mm	Magnet	1/4"	65	£8.00
NSP65513	13 mm	Magnet	1/4"	65	£8.90



1/4" MAGNETIC BIT HOLDER



ACC50MBH01	1/4" Hex	Magnet	50	£7.10
ACC70MBH01	1/4" Hex	Magnet	70	£9.40



1/4" QUICK CHUCK BIT HOLDER 50MM



ACC50CBH01	1/4" Hex	Quick	50	£18.20



BITS & DRIVERS



1/4" QUICK CHUCK BIT HOLDER 35MM



ACC35CBH01

1/4" Hex

Quick

35

£20.30



1/4" QUICK CHUCK IMPACT BIT HOLDER



QC114

1/4" Hex

Quick

60

£13.00



1/4" MAGNETIC IMPACT BIT HOLDER



MBH114

1/4" Hex

Magnet

60

£12.90



1/4" BITS DRIVER EXTENSION



TTMD74-1

1/4" Hex

Hexagon

100

£2.70

TTMD74-2

1/4" Hex

Flexible

150

£4.30



1/4" EXTENSION BAR FOR MDR913



TTRSD15-141	1/4" Hex	Round	141	£13.70
TTRSD15-238	1/4" Hex	Round	238	£17.20



1/4" FLEXIBLE BIT HOLDER



ACC300CBH01	1/4" Hex	Hex bit coupler	300	£24.20



1/4" BIT ADAPTOR MALE



ACCSDA1412	1/4" Hex	1/2"	Hex coupler	50	£11.90
ACCSDA1414	1/4" Hex	1/4"	Hex coupler	50	£6.70
ACCSDA1438	1/4" Hex	3/8"	Hex coupler	50	£9.80



1/4" IMPACT BIT ADAPTOR



IBA14	1/4" Hex	1/2"	Hex coupler	50	£5.60





5/16" BIT SET WITH 1/2" COUPLER TX 4 PIECES

4 PCS 1/2"

- » 5/16" TX Impact Driver Bits
TX45, TX50, TX55
- » 1/2" Bit Adaptor 5/16" Hex



ID515BIT £17.40



5/16" IMPACT BIT SET MIXED 13 PIECES

13 PCS 5/16"

- » 5/16" Hex Impact Driver Bits
4, 5, 6, 8
- » 5/16" PH Impact Driver Bits
PH1, PH2, PH3, PH4
- » 5/16" Flat Impact Driver Bits
6, 8, 10, 12
- » Hex Socket Adaptor 5/16" Hex - 3/8"



ID515BIT £19.20



5/16" IMPACT BIT SET MIXED 4 PIECES

4 PCS 5/16"

- » 5/16" PH Impact Driver Bits
PH2, PH3
- » 5/16" Flat Impact Driver Bits
8, 10



ID506BIT £8.30



BIT SET IPR 10 PIECES

10 PCS 1/4" 1/4"



M1410T5 £32.50



HOOK ON BIT SET MIXED 22 PIECES



- » 1/4" Hex drive impact socket adaptor for 1/4" sockets
- » 1/4" Flat Bits 25 mm
 - » 0.6x4.5, 0.8x5.5, 1.2x6.5
- » 1/4" PH G Bits 25 mm PH2G
- » 1/4" Hex Bits 25 mm
 - » 3, 4, 5, 6
- » 1/4" PH Bits 25 mm
 - » PH1, PH2, PH3
- » 1/4" PZ Bits 25 mm
 - » PZ1, PZ2, PZ3
- » 1/4" TX Bits 25 mm
 - » TX10, TX15, TX20, TX25, TX30, TX40



THBS22

£28.50



BIT SET WITH BELT CLIP MIXED 28 PIECES



- » 1/4" Quick Chuck Bit Holder 50 mm
- » 1/4" Flat Bits 25 mm
 - » 0.6x4.5, 0.8x5.5, 1.2x6.5
- » 1/4" PH G Bits 25 mm PH2G
- » 1/4" Hex Bits 25 mm
 - » 4, 5, 6
- » Hex Socket Adaptor 1/4" Hex - 1/4" 25 mm
- » 1/4" PH Bits 25 mm
 - » PH1, PH2, PH3
- » 1/4" PZ Bits 25 mm
 - » PZ1, PZ2, PZ3
- » 1/4" ROB Bits 25 mm
 - » 1, 2, 3
- » 1/4" TPX Bits 25 mm
 - » TPX20, TPX25, TPX30
- » 1/4" TX Bits 25 mm
 - » TX10, TX15, TX20, TX25, TX30, TX40



TJ028

£47.20





BIT SET WITH BELT CLIP MIXED 29 PIECES



- » 1/4" Mini Bits Ratchet
- » 1/4" Magnetic Bit Holder 50 mm
- » 1/4" Flat Bits 25 mm
 - » 0.6x3.5, 1.0x5.5, 1.6x8.0
- » 1/4" Hex Bits 25 mm
 - » 2, 3, 4, 5, 6, 8
- » 1/4" PH Bits 25 mm
 - » PH1, PH2, PH3
- » 1/4" PZ Bits 25 mm
 - » PZ1, PZ2, PZ3
- » 1/4" ROB Bits 25 mm
 - » 1, 2, 3
- » 1/4" TPX Bits 25 mm
 - » TPX20, TPX25, TPX30
- » 1/4" TX Bits 25 mm
 - » TX10, TX15, TX20, TX25, TX30, TX40



TJ1429

£66.50



IMPACT BIT SET WITH BELT CLIP MIXED 29 PIECES



- » 1/4" PH G Impact Bits 30 mm PH2G
- » 1/4" Hex Impact Bits 30 mm
 - » 3, 4, 5, 6
- » 1/4" Magnetic Impact Bit Holder 60 mm
- » 1/4" PH Impact Bits 30 mm
 - » PH1, PH2, PH3
- » 1/4" PZ Impact Bits 30 mm
 - » PZ1, PZ2, PZ3
- » 1/4" Quick Chuck Impact Bit Holder 60 mm
- » 1/4" ROB Impact Bits 30 mm
 - » 1, 2
- » 1/4" TX Impact Bits 30 mm
 - » TX10, TX15, TX20, TX25, TX27, TX30, TX40



TJ1430

£67.50



IMPACT BIT SET CONSTRUCTION WITH BELT CLIP MIXED 12 PIECES



- » 1/4" PH G Impact Bits 30 mm PH2G
- » 1/4" Magnetic Impact Bit Holder 60 mm
- » 1/4" PH Impact Bits 30 mm PH2
- » 1/4" PZ Impact Bits 30 mm PZ1, PZ2, PZ3
- » 1/4" ROB Impact Bits 30 mm 1, 2
- » 1/4" TX Impact Bits 30 mm TX10, TX20, TX25, TX30



TJ1412 £36.90



IMPACT BIT SET WITH BELT CLIP MIXED 12 PIECES



- » 1/4" PH G Impact Bits 30 mm PH2G
- » 1/4" Hex Impact Bits 30 mm 3, 4, 5
- » 1/4" Magnetic Impact Bit Holder 60 mm
- » 1/4" PZ Impact Bits 30 mm PZ1, PZ2
- » 1/4" ROB Impact Bits 30 mm 1, 2
- » 1/4" TX Impact Bits 30 mm TX20, TX25, TX30



TJ1413 £36.90



IMPACT BIT SET WITH BELT CLIP TX 12 PIECES



- » 1/4" Magnetic Impact Bit Holder 60 mm
- » 1/4" TX Impact Bits 30 mm TX10, TX15, TX20 (*3), TX25 (*2), TX27, TX30 (*2), TX40



TJ1414 £35.20



IMPACT NUT SETTER SET WITH BELT CLIP 5 PIECES



- » 1/4, 7, 8, 10, 13



TJNS05 £48.80



BITS & DRIVERS



1/4" IMPACT DRIVER SET



- » 1/4" Flat Bits 50 mm 5 mm
- » 1/4" Impact Driver
- » 1/4" PH Bits 50 mm
PH1, PH2
- » 1/4" Screw Extractor
1, 2, 3



IDSE7

£25.00



1/2" & 5/16" IMPACT DRIVER SET 15 PIECES



- » 5/16" Hex Impact Driver Bits
4, 5, 6, 8
- » 1/2" Impact Coupler Adaptor 5/16" Hex
- » 5/16" PH Impact Driver Bits
PH1, PH2, PH3, PH4
- » 5/16" Flat Impact Driver Bits
6, 8, 10, 12
- » Hex Socket Adaptor 5/16" Hex - 3/8"



ID515

£44.90



1/2" & 5/16" IMPACT DRIVER SET 6 PIECES



- » 5/16" PH Impact Driver Bits
PH2, PH3
- » 5/16" Flat Impact Driver Bits
8, 10



ID506

£47.10



1/4" MINI BITS RATCHET



1400B

1/4" Hex



8 mm



90

£38.30



1/4" STUBBY BITS DRIVER

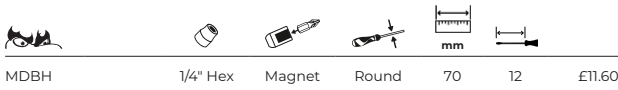

MDBH 1/4" Hex Magnet Round 70 12 £11.60



1/4" MAGNETIC BITS DRIVER 217MM

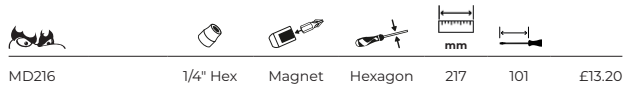

MD216 1/4" Hex Magnet Hexagon 217 101 £13.20



1/4" MAGNETIC BITS DRIVER 193MM

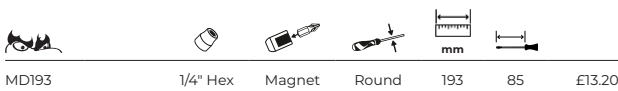

MD193 1/4" Hex Magnet Round 193 85 £13.20



1/4" LONG FLEXIBLE BITS DRIVER

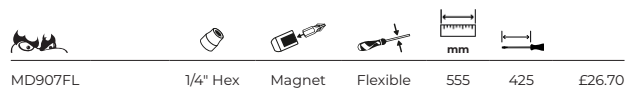

MD907FL 1/4" Hex Magnet Flexible 555 425 £26.70



BITS & DRIVERS



1/4" T HANDLE QUICK CHUCK BITS DRIVER



MDTHQ	1/4" Hex	Quick	Round	75 x 130	75	£23.30



1/4" QUICK CHUCK BITS DRIVER 183MM



MDQ183	1/4" Hex	Quick	Round	183	75	£18.90



1/4" QUICK CHUCK BITS DRIVER 147MM



MDQ147	1/4" Hex	Quick	Round	147	30	£17.60



1/4" QUICK CHUCK BITS DRIVER 217MM



MDQ217	1/4" Hex	Quick	Hexagon	217	101	£19.00



1/4" STUBBY RATCHETING BITS DRIVER SET



- » 1/4" Flat Bits 25 mm
- » 1.0x5.5, 1.4x7.0
- » Hex Socket Adaptor 1/4" Hex - 1/4" 25 mm
- » 1/4" PH Bits 25 mm
- » PH1, PH2
- » 1/4" PZ Bits 25 mm
- » PZ1, PZ2



MDR908S

£23.50



1/4" RATCHETING BITS DRIVER DOUBLE END BITS SET



- » 1/4" Double Ended Flat Bits 4 mm x 6 mm
- » 1/4" Double Ended PH Bits
- » PH0;PH3, PH1;PH2
- » 1/4" Double Ended PZ Bits
- » PZ0;PZ3, PZ1;PZ2
- » 1/4" Double Ended TX Bits
- » TX10;TX15, TX20;25



MDR915

£30.00



1/4" RATCHETING BITS DRIVER SET



- » 1/4" Flat Bits 25 mm
- » 1.0x5.5, 1.4x7.0
- » Hex Socket Adaptor 1/4" Hex - 1/4" 25 mm
- » 1/4" PH Bits 25 mm
- » PH1, PH2
- » 1/4" PZ Bits 25 mm
- » PZ1, PZ2



MDR908

£25.10



1/4" RATCHETING ANGLED BITS DRIVER SET



- » 1/4" Flat Bits 25 mm
- » 1.0x5.5, 1.4x7.0
- » Hex Socket Adaptor 1/4" Hex - 1/4" 25 mm
- » 1/4" PH Bits 25 mm
- » PH1, PH2
- » 1/4" PZ Bits 25 mm
- » PZ1, PZ2



MDRT908

£64.70





1/4" RATCHETING QUICK CHUCK BITS DRIVER



- » 1/4" Flat Bits 25 mm
- » 1.0x5.5, 1.4x7.0
- » Hex Socket Adaptor 1/4" Hex - 1/4" 25 mm
- » 1/4" PH Bits 25 mm
- » PH1, PH2
- » 1/4" PZ Bits 25 mm
- » PZ1, PZ2



MDRQ908

£32.90

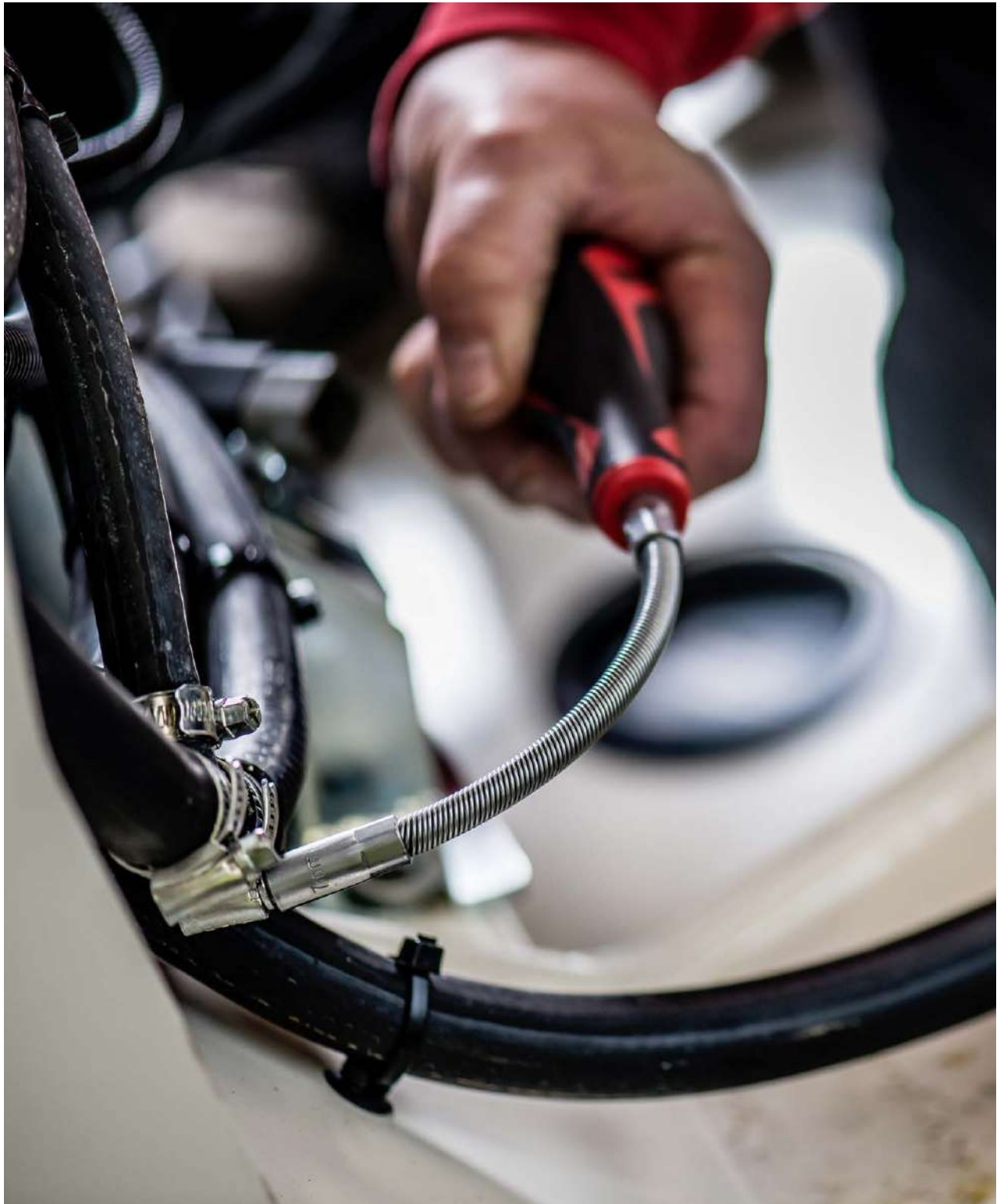

HEX & TX KEYS

VERSATILE, STRONG AND DURABLE

TengTools wide range of hex & TX keys consists of a range of keys made of chrome vanadium steel for industrial use and a series made of chrome-molybdenum for heavy duty usage.



CHROME VANADIUM STEEL

Stronger, harder and more durable than regular carbon steels. This guarantees the high level of quality that you would expect from a TengTools item

Our cases are designed to hold the wrenches tight enough so they didn't fall out but with a flexible enough grip that they were are still easily removed

For higher torque applications it is better to use the straight end Hex keys for maximum fastener engagement

Available in metric & imperial sizes up to 36 mm or 5/8"



CHROME MOLYBDENUM STEEL

It is an alloy tool steel with chromium (Cr), molybdenum (Mo), iron (Fe) and carbon (C) alloy elements. The highest quality steel that we use. It is particularly hard and strong, but also has an amount of flex. Ideal to use when more torque is required.

Ballpoint heads are ideal for areas that are hard to reach. Fastenings can be turned at an angle of 25° in a Hex or TX key.

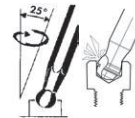





-
-
-
-
-
-
-
-
-
-
-
-
-
-
-
-
-
-

HEX & TX KEYS



HEX KEY METRIC





			 mm	
3105007	0.7 mm		8 × 35	£1.50
3105009	0.9 mm		10 × 38	£1.50
3105013	1.3 mm		12 × 41	£1.50
3105015	1.5 mm		14 × 45	£1.50
310502	2 mm		16 × 50	£1.60
3105025	2.5 mm		18 × 56	£1.50
310503	3 mm		20 × 63	£1.60
310504	4 mm		25 × 70	£2.00
3105045	4.5 mm		26 × 75	£2.00
310505	5 mm		28 × 80	£2.20
3105055	5.5 mm		30 × 85	£2.10
310506	6 mm		32 × 90	£2.20
310507	7 mm		34 × 95	£2.70
310508	8 mm		36 × 100	£2.90
310509	9 mm		38 × 106	£3.20
310510	10 mm		40 × 112	£4.00
310511	11 mm		42 × 118	£6.50
310512	12 mm		45 × 125	£6.70
310514	14 mm		56 × 140	£9.30
310516	16 mm		60 × 152	£14.00
310517	17 mm		63 × 160	£15.00
310518	18 mm		66 × 170	£21.70
310519	19 mm		70 × 180	£21.20
310522	22 mm		80 × 200	£32.60
310527	27 mm		100 × 250	£59.10
310532	32 mm		125 × 315	£107.00
310536	36 mm		140 × 355	£146.00



EXTRA LONG HEX KEY METRIC



			 mm	
3205015	1.5 mm		14 × 90	£2.00
320502	2 mm		16 × 100	£2.00
3205025	2.5 mm		18 × 112	£2.40
320503	3 mm		20 × 126	£2.50
320504	4 mm		24 × 140	£2.80
320505	5 mm		28 × 160	£3.10
320506	6 mm		32 × 180	£3.70
320508	8 mm		36 × 200	£5.00
320510	10 mm		40 × 224	£7.00

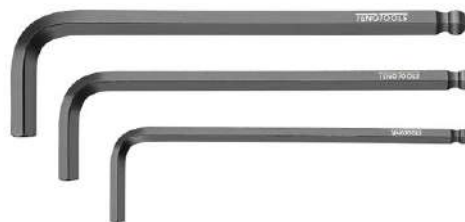



BALL POINT HEX KEY METRIC



			 mm	
3105015BL-C	1.5 mm		14 × 77	£3.30
3105025BL-C	2.5 mm		18 × 90	£3.30
310502BL-C	2 mm		16 × 83	£3.30
310503BL-C	3 mm		20 × 98	£3.30
310504BL-C	4 mm		25 × 106	£3.70
310505BL-C	5 mm		28 × 118	£4.00
310506BL-C	6 mm		32 × 137	£4.40
310507BL-C	7 mm		34 × 147	£5.60
310508BL-C	8 mm		36 × 156	£6.00
310510BL-C	10 mm		40 × 170	£8.10
310512BL-C	12 mm		45 × 207	£14.60
310514BL-C	14 mm		56 × 230	£23.00
310517BL-C	17 mm		63 × 250	£34.70
310519BL-C	19 mm		70 × 280	£49.60

BALL POINT HEX KEY CR-MO METRIC



			 mm	
3905015BL	1.5 mm		14 × 77	£3.70
3905025BL	2.5 mm		18 × 90	£4.00
390502BL	2 mm		16 × 83	£3.80
390503BL	3 mm		20 × 98	£4.00
390504BL	4 mm		25 × 106	£4.00
390505BL	5 mm		28 × 118	£4.70
390506BL	6 mm		32 × 137	#REF!
390508BL	8 mm		36 × 156	£6.70
390510BL	10 mm		40 × 170	£8.80



HEX & TX KEYS



EXTRA LONG BALL POINT HEX KEY METRIC



			
		mm	
3908015BL	1.5 mm	14 × 90	£3.10
3908020BL	2 mm	16 × 100	£3.10
3908025BL	2.5 mm	18 × 112	£3.60
390803BL	3 mm	20 × 126	£4.30
390804BL	4 mm	25 × 140	£4.50
390805BL	5 mm	28 × 160	£5.20
390806BL	6 mm	32 × 180	£5.80
390808BL	8 mm	36 × 200	£7.60
390810BL	10 mm	40 × 224	£10.30



HEX KEY AF



			
		mm	
310102	1/16 in	14 × 44	£1.30
3101025	5/64 in	15 × 48	£1.30
310103	3/32 in	17 × 51	£1.30
3101035	7/64 in	18 × 54	£1.30
310104	1/8 in	19 × 57	£1.30
3101045	9/64 in	20 × 64	£1.30
310105	5/32 in	21 × 64	£1.80
310106	3/16 in	24 × 70	£1.80
310107	7/32 in	26 × 76	£1.90
310108	1/4 in	28 × 83	£2.00
310110	5/16 in	32 × 95	£2.80
310112	3/8 in	35 × 108	£3.40
310114	7/16 in	38 × 121	£6.40
310116	1/2 in	41 × 133	£8.30
310120	5/8 in	48 × 159	£15.10



BALL POINT HEX KEY AF



		 mm	
3101025BL	5/64 in	15 × 82	£3.50
310103BL	3/32 in	17 × 88	£4.30
310104BL	1/8 in	19 × 96	£4.30
310105BL	5/32 in	21 × 105	£4.40
310106BL	3/16 in	24 × 114	£4.70
310107BL	7/32 in	26 × 124	£5.00
310108BL	1/4 in	28 × 135	£5.50
310110BL	5/16 in	32 × 151	£7.00
310112BL	3/8 in	35 × 170	£8.80



BALL POINT HEX KEY CR-MO AF



		 mm	
3901025BL	5/64 in	15 × 82	£4.00
390103BL	3/32 in	17 × 88	£4.50
390104BL	1/8 in	19 × 96	£5.10
390105BL	5/32 in	21 × 105	£5.10
390106BL	3/16 in	24 × 114	£5.40
390107BL	7/32 in	26 × 124	£5.70
390108BL	1/4 in	28 × 135	£6.20
390110BL	5/16 in	32 × 151	£8.00
390112BL	3/8 in	35 × 170	£9.70





HEX & TX KEYS



T HANDLE HEX KEY METRIC





			
		mm	
5106025	2.5 mm	15 × 100	£8.90
510603	3 mm	15 × 100	£8.80
510604	4 mm	15 × 100	£9.00
510605	5 mm	18 × 150	£9.70
510606	6 mm	18 × 150	£10.10
510607	7 mm	18 × 150	£12.40
510608	8 mm	18 × 190	£12.50



T HANDLE BALL POINT HEX KEY METRIC



			
		mm	
510502	2 mm	12 × 100	£8.70
5105025	2.5 mm	12 × 100	£8.90
510503	3 mm	12 × 100	£8.70
510504	4 mm	12 × 100	£8.80
510505	5 mm	15 × 150	£9.70
510506	6 mm	15 × 150	£10.00
510507	7 mm	15 × 150	£12.60
510508	8 mm	18 × 190	£13.00
510510	10 mm	20 × 200	£20.20
510512	12 mm	20 × 200	£23.00



T HANDLE BALL POINT HEX KEY AF



		mm	
510103	3/32 in	12 × 100	£9.30
510104	1/8 in	12 × 100	£9.70
510105	5/32 in	12 × 100	£9.90
510106	3/16 in	12 × 100	£10.70
510107	7/32 in	15 × 150	£11.50
510108	1/4 in	15 × 150	£13.00
510110	5/16 in	18 × 190	£13.70



HEX KEY SET METRIC MINI 7 PIECES



»	
0.9, 1.3, 1.5, 2, 2.5, 3, 4	
1477MM	£8.50



HEX KEY SET AF MINI 7 PIECES



»	
Hex Key AF	
1/16, 5/64, 3/32, 7/64	
Hex Key Metric	
0.7, 0.9, 1.3	
1477AF	£8.50



HEX KEY SET 9 PIECES



»	
1.5, 2, 2.5, 3, 4, 5, 6, 8, 10	
1479MMR	£16.20



HEX & TX KEYS



EXTRA LONG HEX KEY SET 9 PIECES



»	1.5, 2, 2.5, 3, 4, 5, 6, 8, 10
---	--------------------------------



1479MMRL

£28.20



BALL POINT HEX KEY SET 9 PIECES



»	1.5, 2, 2.5, 3, 4, 5, 6, 8, 10
---	--------------------------------



1479MM

£27.40



BALL POINT HEX KEY SET 7 PIECES



»	2.5, 3, 4, 5, 6, 8, 10
---	------------------------



1475

£23.60



BALL POINT HEX KEY SET A 9 PIECES



»	1.5, 2, 2.5, 3, 4, 5, 6, 7, 10
---	--------------------------------



1479MMA

£27.20



BALL POINT HEX KEY SET CR-MO 9 PIECES



» 1.5, 2, 2.5, 3, 4, 5, 6, 8, 10



1499MM

£34.40



HEX KEY SET BALL POINT METRIC 2 - 19 MM 13 PIECES



» 2, 2.5, 3, 4, 5, 6, 7, 8, 10, 12, 14, 17, 19



1479MMJ

£99.90



EXTRA LONG BALL POINT HEX KEY SET CR-MO 9 PIECES



» 1.5, 2, 2.5, 3, 4, 5, 6, 8, 10



1499MML

£43.90



BALL POINT HEX KEY SET AF 7 PIECES



» 1/8, 5/32, 3/16, 7/32, 1/4, 5/16, 3/8



1474

£23.60



HEX & TX KEYS



BALL POINT HEX KEY SET AF 9 PIECES



» 5/64, 3/32, 1/8, 5/32, 3/16, 7/32, 1/4, 5/16, 3/8



1479AF

£28.20



FOLDING HEX KEY SET 1.5-6 MM ALU 7 PIECES



» 1.5, 2, 2.5, 3, 4, 5, 6 mm



1476NMM

£20.50



BALL POINT HEX KEY SET CR-MO AF 9 PIECES



» 5/64, 3/32, 1/8, 5/32, 3/16, 7/32, 1/4, 5/16, 3/8



1499AF

£34.40



FOLDING HEX KEY SET 2.5-10 MM ALU 7 PIECES



» 2.5, 3, 4, 5, 6, 8, 10 mm



1476NMM1

£23.20

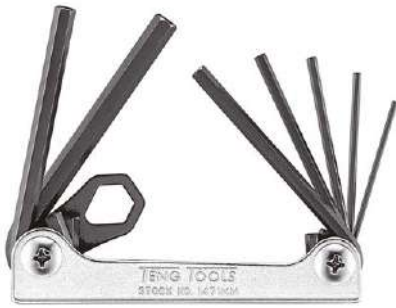

FOLDING HEX KEY SET 1.5-6 MM 7 PIECES



- » 1.5, 2, 2.5, 3, 4, 5, 6 mm



1471MM

£15.60



FOLDING HEX KEY SET AF ALU 7 PIECES



- » 1/16, 5/64, 3/32, 1/8, 5/32, 3/16, 7/32 in



1476NAF

£20.30



FOLDING HEX KEY SET 2.5-10 MM 7 PIECES



- » 1.5, 2, 2.5, 3, 4, 5, 6 mm



1471MMA

£19.90

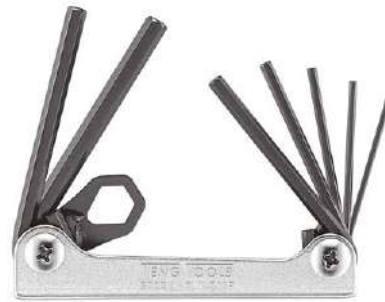

FOLDING HEX KEY SET AF 7 PIECES



- » 1/16, 5/64, 3/32, 1/8, 5/32, 3/16, 7/32 in



1471AF

£15.30



HEX & TX KEYS



FOLDING HEX KEY SET AF 6 PIECES



» 1/8, 5/32, 3/16, 1/4, 5/16, 3/8 in



1471AFA

£19.90



HEX KEY SET AF 10 PIECES



» 1/16, 5/64, 3/32, 1/8, 5/32, 3/16, 7/32, 1/4, 5/16, 3/8



1424

£10.90



TX KEY





mm

320008	TX8	16 × 80	£4.70
320009	TX9	16 × 83	£4.70
320010	TX10	17 × 86	£5.00
320015	TX15	18 × 90	£5.20
320020	TX20	19 × 95	£5.30
320025	TX25	20 × 100	£5.70
320027	TX27	22 × 105	£5.80
320030	TX30	24 × 114	£6.20
320040	TX40	26 × 124	£6.80
320045	TX45	29 × 133	£8.00
320050	TX50	32 × 152	£9.20





BALL POINT TX KEY



				
		mm		
320008BL	TX8	16 × 80		£6.30
320009BL	TX9	16 × 83		£6.30
320010BL	TX10	17 × 86		£6.30
320015BL	TX15	18 × 90		£6.30
320020BL	TX20	19 × 95		£6.80
320025BL	TX25	20 × 100		£6.80
320027BL	TX27	22 × 105		£6.80
320030BL	TX30	24 × 114		£7.00
320040BL	TX40	26 × 124		£7.40
320045BL	TX45	29 × 133		£9.30
320050BL	TX50	32 × 152		£10.00

BALL POINT TX KEY CR-MO



				
		mm		
390908BL	TX8	16 × 80		£7.20
390909BL	TX9	16 × 83		£7.20
390910BL	TX10	17 × 86		£7.30
390915BL	TX15	18 × 90		£7.30
390920BL	TX20	19 × 95		£7.80
390925BL	TX25	20 × 100		£7.80
390927BL	TX27	22 × 105		£7.90
390930BL	TX30	24 × 114		£8.10
390940BL	TX40	26 × 124		£8.50



HEX & TX KEYS



TPX KEY CR-MO



		mm	
390808TPX	TPX8	16 × 80	£5.20
390809TPX	TPX9	16 × 83	£5.20
390810TPX	TPX10	17 × 86	£5.60
390815TPX	TPX15	18 × 90	£5.80
390820TPX	TPX20	19 × 95	£6.20
390825TPX	TPX25	20 × 100	£6.80
390827TPX	TPX27	22 × 105	£7.00
390830TPX	TPX30	24 × 114	£7.40
390840TPX	TPX40	26 × 124	£8.00



TX KEY SET 9 PIECES



»	TX8, TX9, TX10, TX15, TX20, TX25, TX27, TX30, TX40	
	1479TX	£35.60

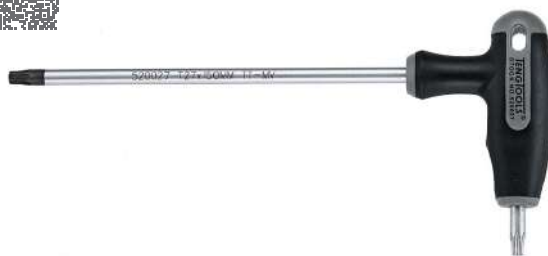

T HANDLE TX KEY



		mm	
520009	TX9	12 × 100	£8.80
520010	TX10	12 × 100	£8.80
520015	TX15	12 × 100	£8.80
520020	TX20	12 × 100	£8.80
520025	TX25	15 × 150	£9.80
520027	TX27	15 × 150	£9.80
520030	TX30	15 × 150	£11.00
520040	TX40	18 × 190	£11.80
520045	TX45	20 × 200	£12.80
520055	TX55	20 × 200	£18.90



BALL POINT TX KEY SET 9 PIECES



»	TX8, TX9, TX10, TX15, TX20, TX25, TX27, TX30, TX40	
	1479TX1	£45.10



BALL POINT TX KEY SET CR-MO 9 PIECES



» TX8, TX9, TX10, TX15, TX20, TX25, TX27, TX30, TX40



1499TX £54.50



FOLDING TX KEY SET 8 PIECES



» TX9, TX10, TX15, TX20, TX25, TX27, TX30, TX40



1476NTX £29.10



FOLDING TPX KEY SET CR-MO 9 PIECES



» TPX8, TPX9, TPX10, TPX15, TPX20, TPX25, TPX27, TPX30, TPX40



1498TPX £48.00



FOLDING BALL POINT TX KEY SET 8 PIECES



» TX9, TX10, TX15, TX20, TX25, TX27, TX30, TX40



1476NTX1 £40.40



HEX & TX KEYS

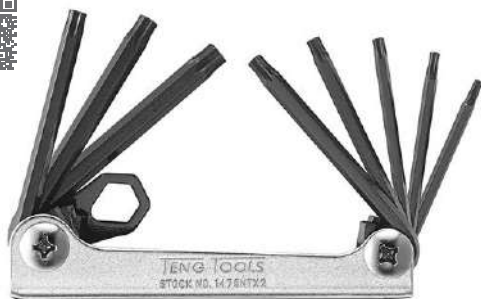

FOLDING TX KEY SET CR-MO 8 PIECES



» TX9, TX10, TX15, TX20, TX25, TX27, TX30, TX40



1476NTX2

£28.80



FOLDING KEY SET MIXED 8 PIECES



» 1.0 x 5.5, PH2, TX25, TX30, HEX4, HEX5, HEX6



1477NX

£33.20



TX KEY SET 7 PIECES



» TX10, TX15, TX20, TX25, TX27, TX30, TX40



1487

£22.90



Scan the QR code
to contact us or
request a call back





PLIERS

DESIGNED TO MAXIMISE PERFORMANCE

The extensive TengTools range includes pliers for most applications. In addition, the range includes the usual side cutters, combination pliers and slip joint pliers as well as a number of cable pliers, side cutters for cable ties, frapping pliers, nail nippers, electronic pliers, precision shears and tweezers. Two types of handles are available to choose from: slim rubber dipped as well as ergonomic TPR bi-material handles.

Made from chrome molybdenum alloy steel for maximum durability and strength

The cutting capacity is laser marked next to the cutting edge makes it easy to see which pliers you need to choose

TPR GRIP

An ergonomic bi-material handle that is more comfortable in your hand

Extra support when using greater force and a lighter weight

The total length is designed to provide maximum leverage for each pair of pliers, irrespective of whether they are combination, water pump, flat or circlip pliers

VINYL GRIP

A light compact material that is textured to avoid the tool slipping in your hand. The slim design allows for greater access in tight spaces





PLIERS



SIDE CUTTING PLIER



	mm	af					
MB441-5	135	5	1.5	1.8	2.3	4	£22.00
MB441-6	160	6	1.6	2	2.5	4	£25.60
MB442-5	140	5	1.5	1.8	2.3	4	£26.80
MB442-6	160	6	2	2.5	3.8	4	£26.20
MB442-7	180	7	2	2.5	4	4	£30.70
MB442-8	200	8	2.5	3	4	4	£31.90



SIDE CUTTING PLIER TPR GRIP



	mm	af					
MB441-5T	140	5	1.5	1.8	2.3	4	£25.30
MB441-6T	160	6	1.6	2	2.5	4	£28.60
MB442-6T	165	6	2	2.5	3.8	4	£28.60
MB442-8T	200	8	2.5	3	4	4	£35.00



HEAVY DUTY SIDE CUTTING PLIER WITH SPRING



	mm	af					
MB442-7S	180	7	2	2.5	4	4	£39.40



HEAVY DUTY SIDE CUTTING PLIER TPR GRIP





	mm	af					
MB442B-8T	200	8	2.5	3	4	4	£35.40



FLUSH CUT PLIER







	 mm	 af	
 MB541-5	125	5	£34.10
MB541-6	150	6	£36.10
MB541-7	185	7	£44.90



CABLE CUTTER TPR GRIP







	 mm	 af	 mm ²	
 MB444-8T	208	8	38	£38.00



CABLE CUTTER















	 mm	 af	 mm ²	
 MB444-6	160	6	22	£32.10
MB444-8	200	8	38	£37.00
MB444-10	250	10	60	£53.00



HEAVY DUTY CABLE CUTTER



	 mm	 af	 mm ²	
 MB445-10	250	10	60	£58.00

	Piano Wire		Steel Wire
	Hard Wire		Stainless Steel Wire
	Medium Hard Wire		Spring Steel Wire
	Soft Wire		Iron Wire

PLIERS



HEAVY DUTY CABLE CUTTER BI MATERIAL HANDLE



496	250	10	12	£38.10



MINI BOLT CUTTER



BC408	200	8	3.6	5.2	4	£62.60



CABLE/WIRE CUTTER



498-7N	190	7	1.5	4	£37.60



MINI BOLT CUTTER TPR GRIP







BC408T	200	8	3.6	5.2	4	£64.40

- | | | | |
|--|------------------|--|----------------------|
| | Piano Wire | | Steel Wire |
| | Hard Wire | | Stainless Steel Wire |
| | Medium Hard Wire | | Spring Steel Wire |
| | Soft Wire | | Iron Wire |









BOLT CUTTER

	 mm	 af	 mm HRC15	 mm HRC40	
BC414	350	14	7	4	£69.00
BC418	450	18	8	5	£83.00
BC424	600	24	10	6	£106.00
BC430	750	30	13	7	£147.00
BC436	900	36	16	8	£181.00







END NIPPER

	 mm	 af				
MB448-8	200	8	1.6	1.8	3.4	£44.00



CARPENTERS PLIER









	 mm	 af			
MB489-7	180	7	2	1.6	£34.50
MB489-8	200	8	2.2	1.8	£41.50



TOWER PINCER PLIER



	 mm	 af				
MB449-9	220	9	1.8	2	3.4	£35.70
MB449-10	250	10	2	2.2	3.8	£38.60
MB449-11	280	11	2.5	3	4	£39.80



PLIERS



COMBINATION PLIER



	mm	af				
MB451-7	180	7	1.8	2	3.8	£26.60
MB451-8	200	8	2	2.2	4	£31.10



HEAVY DUTY COMBINATION PLIER TPR GRIP



	mm	af				
MB452-6T	170	6	1.6	1.8	3.4	£31.80
MB452-7T	190	7	1.8	2	3.8	£33.20
MB452-8T	200	8	2	2.2	4	£37.10



HEAVY DUTY COMBINATION PLIER



	mm	af				
MB452-6	165	6	1.6	1.8	3.4	£29.80
MB452-7	185	7	1.8	2	3.8	£32.00
MB452-8	200	8	2	2.2	4	£34.80



LONG NOSE PLIER



	mm	af				
MB461-5	140	5	1	1.5	2.5	£25.50
MB461-6	165	6	1	1.5	2.5	£26.20
MB461-8	200	8	1.5	1.8	2.8	£30.00



LONG NOSE PLIER TPR GRIP



	mm	af				
MB461-6T	170	6	1	1.5	2.5	£28.00
MB461-8T	205	8	1.5	1.8	2.8	£32.40

BENT LONG NOSE PLIER TPR GRIP



	mm	af				
MB463-8T	210	8	1.5	1.8	2.8	£32.50



BENT LONG NOSE PLIER



	mm	af				
MB463-5	140	5	1	1.5	2.5	£27.60
MB463-6	160	6	1	1.5	2.5	£29.00
MB463-8	200	8	1.5	1.8	2.8	£30.50

FLAT NOSE PLIER



	mm	af	
MB464-6	165	6	

	Piano Wire		Steel Wire
	Hard Wire		Stainless Steel Wire
	Medium Hard Wire		Spring Steel Wire
	Soft Wire		Iron Wire

PLIERS



FLAT NOSE PLIER TPR GRIP



MB464-6T

170

6

£25.90



LONG REACH PLIER



AT094

275

£33.40

AT096

275

11

£31.80

AT097

275

11

£31.80



ROUND NOSE PLIER



MB465-6

165

6

£28.90



GROOVE JOINT WATER PUMP PLIER



MB410

250

10

45.0

£31.30

MB412

300

12

60.0

£45.10

MB416

400

16

90.0

£71.20



WATER PUMP PLIER



	mm	af	mm	
MB481-7	180	7	35.0	£28.80
MB481-10	240	10	38.0	£33.50



QUICK SET WATER PUMP PLIER HRC60



	mm	af	mm	
MB481-10Q	245	10	39.0	£50.50



WATER PUMP PLIER TPR GRIP



	mm	af	mm	
MB481-10T	250	10	38.0	£36.20



QUICK SET WATER PUMP PLIER HRC60



	mm	af	mm	
MB482-7Q	185	7	38	£46.10
MB482-10Q	250	10	50.0	£53.10
MB482-12Q	300	12	70.0	£65.20



PLIERS



QUICK SET WATER PUMP PLIER TPR GRIP HRC60



MB482-7TQ	185	7	38	
MB482-10TQ	250	10	50.0	£52.80



MINI SIDE CUTTING PLIER



MBM441	115	5		£26.20
--------	-----	---	--	--------



PLIER SET TOOL ROLL 5 PIECES



- » Side Cutting Plier 160 mm
- » Combination Plier 180 mm
- » Long Nose Plier 200 mm
- » Water Pump Plier 240 mm
- » Mini Side Cutting Plier 115 mm



445W				£139.90
------	--	--	--	---------



MINI END CUTTING PLIER



MBM449	110	4.5		£26.20
--------	-----	-----	--	--------



MINI LONG NOSE PLIER



mm



af

MBM461

140

5

£26.20



MINI ROUND NOSE PLIER



mm



af

MBM467

125

5

£29.80



MINI FLAT NOSE PLIER



mm



af

MBM464

140

5.5

£26.20



MINI NEEDLE NOSE PLIER



mm



af

MBM468

140

5.5

£30.20



PLIERS



MINI BENT LONG NOSE PLIER



MBM469

140

5.5

£30.20



CIRCLIP PLIER INNER BENT PRO



MBE471-5

1.3 mm

125

5

12 - 25

£28.20

MBE471-7

1.8 mm

170

7

19 - 60

£29.80

MBE471-9

2.3 mm

220

9

40 - 100

£46.20



CIRCLIP PLIER INNER STRAIGHT PRO



MBE470-5

1.3 mm

135

5

12 - 25

£28.20

MBE470-7

1.8 mm

185

7

19 - 60

£29.80

MBE470-9

2.3 mm

235

9

40 - 100

£46.20



CIRCLIP PLIER OUTER STRAIGHT PRO



MBE472-5

1.3 mm

135

5

12 - 25

£28.20

MBE472-7

1.8 mm

175

7

19 - 60

£29.80

MBE472-9

2.3 mm

235

9

40 - 100

£46.20



CIRCLIP PLIER OUTER BENT PRO



MBE473-5	1.3 mm	125	5	12 – 25 £28.20
MBE473-7	1.8 mm	165	7	19 – 60 £29.80
MBE473-9	2.3 mm	220	9	40 – 100 £46.20



20" STRAIGHT/BENT RATCHETING CIRCLIP PLIER



MB472-20	3.4 mm	505	20	165 – 300 £194.90



20" STRAIGHT/BENT RATCHETING CIRCLIP PLIER



MB470-20	3.5 mm	505	20	165 – 300 £194.90



CIRCLIP PLIER INTERCHANGEABLE TIPS





480	10 – 50	£26.20

PLIERS



CURVED JAW POWER GRIP PLIER



CrMo

	 mm	 af	 mm	
401-4	105	4	25	£19.00
401-5	125	5	28	£20.00
401-7	190	7	45	£22.00
401-10	235	10	51	£24.80
401-12	300	12	50	£33.00



LONG NOSE POWER GRIP PLIER



CrMo

	 mm	 af	 mm	
404-4	125	4	35	£21.20
404-6	170	6.7	50	£22.80
404-9	230	9	70	£26.50



FLAT JAW POWER GRIP PLIER

CrMo



	 mm	 af	 mm	
401-10F	250	10	45	£24.80
401-12F	300	12	52	£33.00



LONG NOSE POWER GRIP PLIER NON PINCH

CrMo



	 mm	 af	 mm	
404-6S	160	6	35	£22.80



POWER GRIP PLIER SET

CrMo

- » Long Nose Power Grip Plier 170 mm
- » Curved Jaw Power Grip Plier 235mm



402 £46.50



C CLAMP POWER GRIP PLIER NON PINCH

CrV

	 mm	 af	 mm	
406-6S	172	6	0-50	£25.80
406S	285	11	0-80	£36.40



C CLAMP POWER GRIP PLIER

CrV

	 mm	 af	 mm	
406-6	172	6	0-50	£29.70
406	280	11	0-80	£37.40



SWIVEL C CLAMP POWER GRIP PLIER NON PINCH

CrV

	 mm	 af	 mm	
406-6SP	172	6	0-50	£31.70
406SP	285	11	0-80	£48.10

PLIERS



SWIVEL C CLAMP POWER GRIP PLIER

CrV



mm

af

mm

406-6P	172	6	0-50	£31.70
406P	280	11	0-80	£47.80



SWIVEL C CLAMP LONG POWER GRIP PLIER

CrV



mm

af

mm

418SP	450	18	0-150	£74.70
-------	-----	----	-------	--------



C CLAMP LONG POWER GRIP PLIER

CrV



mm

af

mm

418S	450	18	0-150	£73.20
------	-----	----	-------	--------



WELDING POWER GRIP PLIER

CrV



mm

af

mm

407	230	9	0-65	£37.60
-----	-----	---	------	--------



SHEET METAL POWER GRIP PLIER



408	230	9	0-35	£37.20



SWIVEL CLAMPING POWER GRIP PLIER NON PINCH



409SP	300	12	0-65	£48.00



SWIVEL CLAMPING POWER GRIP PLIER



409P	300	12	0-65	£46.80



TABLE CLAMP







410SP	230	0-65	£47.40
410P	320	0-65	£46.60







PLIERS



ALUMINIUM PIPE WRENCH

	 mm	 af	 mm	
PWC12	300	12	43	£51.00
PWC14	350	14	50	£64.00
PWC18	450	18	60	£88.00
PWC24	600	24	76	£136.00
PWC36	900	36	102	£280.00

TELESCOPIC BASIN TAP WRENCH

	 1 (mm)	 2 (mm)	 mm	
BWT406	275	400	32-48	£37.20



INSULATED TOOLS

PROTECT YOURSELF FROM ELECTRIC SHOCK

All 1000-volt tools from TengTools conform to or exceed all specifications that the relevant authorities have established. Each tool is individually tested before it is marked with a special standard tag and a marking that indicates the year of manufacture.



INSULATED SCREWDRIVERS

The bi-material handle is designed for increased comfort and smooth action preventing blisters after continuous use. It gives better support and increased power transfer.

Size and tip marked at the bottom of each handle for easy identification

Integrated protective insulation with two colours to clearly indicate if there is any damage to the insulation

RBD shafts are ultra slim allowing for recessed screws to be accessed easily

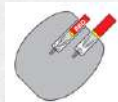

TT-MV PLUS steel alloy for greater strength and material flexibility



INSULATED RATCHET

Twist reverse mechanism for quickly changing between tightening and loosening

Insulation made in two parts, yellow insulating core and a red outer layer. Any damage to the insulation can be detected quickly with the visibility of the yellow core layer

72 Teeth ratchet give a working arc of just 5° making it ideal for working in confined spaces

Insulation properties have been tested in resistance to cold and fire as well as in pressurised environments

Ergonomically designed handle for increased comfort and smooth action



INSULATED TOOLS



FLAT SLIM INSULATED SCREWDRIVER



MDV724N	0.8 × 4.0 mm	208	100 mm	51 g	M	£10.80	
MDV726N	1.0 × 5.5 mm	233	125 mm	67 g	M	£12.10	



PH SLIM INSULATED SCREWDRIVER



MDV742N	PH1	188	80 mm	51 g	M	£10.60	
MDV744N	PH2	216	100 mm	93 g	L	£13.40	



FLAT INSULATED SCREWDRIVER



MDV820N	0.4 × 2.5 mm	171	75 mm	26 g	S	£8.10	
MDV822N	0.5 × 3.0 mm	196	100 mm	30 g	S	£8.10	
MDV823N	0.6 × 3.5 mm	196	100 mm	32 g	S	£8.50	
MDV824N	0.8 × 4.0 mm	208	100 mm	53 g	M	£10.10	
MDV826N	1.0 × 5.5 mm	233	125 mm	72 g	M	£11.10	
MDV828N	1.2 × 6.5 mm	266	150 mm	118 g	L	£14.10	



PH INSULATED SCREWDRIVER



MDV840N	PH0	156	60 mm	27 g	S	£8.00	
MDV842N	PH1	188	80 mm	54 g	M	£10.00	
MDV844N	PH2	216	100 mm	98 g	L	£13.50	
MDV846N	PH3	275	150 mm	162 g	XL	£17.80	



PZ SLIM INSULATED SCREWDRIVER



MDV762N	PZ1	188	80 mm	51 g	M	£10.70
MDV764N	PZ2	216	100 mm	93 g	L	£13.50



FLAT/PH INSULATED SCREWDRIVER



MDV844NF	Flat/PH2	216	100 mm	103 g	L	£13.30
MDV864NF	Flat/PZ2	216	100 mm	104 g	L	£12.80



PZ INSULATED SCREWDRIVER



MDV860N	PZ0	156	60 mm	26 g	S	£9.30
MDV862N	PZ1	188	80 mm	54 g	M	£10.00
MDV864N	PZ2	216	100 mm	98 g	L	£13.40
MDV866N	PZ3	275	150 mm	163 g	XL	£18.90



ROB INSULATED SCREWDRIVER



MDV802N	2	216	100 mm	98 g	L	£12.60

Insulated according to IEC 60900, usable up to 1000 V
VDE tested, also in conformance to GPSC (Equipment and Product Safety Act)



INSULATED TOOLS



INSULATED HANDLE FOR INTERCHANGEABLE BLADES



MDV700

122

66 g

£11.30



INSULATED HANDLE FOR INTERCHANGEABLE BLADES



MDV710

100

26 g

£10.70



INTERCHANGEABLE BLADE INSULATED SCREWDRIVER



MDV731

3 mm

111

60 mm

9 g

£5.30

MDV732

4 mm

151

100 mm

15 g

£6.40

MDV733

5.5 mm

131

80 mm

21 g

£7.30

MDV734

6.5

151

100 mm

28 g

£7.70

MDV751

PH1

131

80 mm

15 g

£6.50

MDV752

PH2

151

100 mm

26 g

£7.70

MDV771

PZ1

131

80 mm

15 g

£6.50

MDV772

PZ2

151

100 mm

26 g

£7.70



Insulated according to IEC 60900,
usable up to 1000 V

VDE tested, also in conformance to GPSG
(Equipment and Product Safety Act)



INSULATED TORQUE SCREWDRIVER



1492TVSD	1-5 Nm	0.02 ± 6%	Factory	213	82	222 g	£162.20
1492TVSD-CT	1-5 Nm	0.02 ± 6%	New	213	82	222 g	£222.20



Manufactured to the highest standard

IEC 60900 is an international standard that defines the requirements and test methods for insulated hand tools intended for live working up to 1000 V AC and 1500 V DC.

EN 60900 is the European adoption of IEC 60900, technically identical to the international version, specifying the same mechanical, thermal and dielectric tests (including the 10,000-volt insulation test) to ensure tools are safe for use at 1,000 V.

VDE is an independent authority that tests and checks tools with regard to construction, production and packaging



INSULATED INTERCHANGEABLE BLADE SET WALLET 9 PIECES



- » Insulated Handle for Interchangeable Blades L
- » Interchangeable Blade Insulated Screwdriver
- » 3, 4, 5.5, 6.5, PH1, PH2, PZ1, PZ2



MDV909N £65.90



INSULATED SCREWDRIVER SET FLAT & PH 6 PIECES



- » Flat Insulated Screwdriver
- » 0.4×2.5, 0.5×3.0, 0.8×4.0, 1.0×5.5
- » PH Insulated Screwdriver
- » PH1, PH2



MDV906N £54.50



INSULATED TOOLS



INSULATED SIDE CUTTING PLIER



						List Price
MBV441-6	160	6	1.6	2	2.5	£32.90



INSULATED COMBINATION PLIER



						List Price
MBV451-7	185	7	1.8	2	3.8	£42.00
MBV451-8	200	8	2	2.2	4	£45.80



INSULATED SIDE CUTTING PLIER



						List Price
MBV442-8	205	8	2.5	3	4	£44.80



INSULATED LONG NOSE PLIER



						List Price
MBV461-8	215	8	1.5	1.8	2.8	£40.80
MBV463-8	210	8	1	1.5	2.5	£36.40



Insulated according to IEC 60900, usable up to 1000 V
VDE tested, also in conformance to GPSC (Equipment and Product Safety Act)



Piano Wire



Hard Wire



Medium Hard Wire



INSULATED WIRE STRIPPING PLIER



			List Price
MBV499-7	160	6	£37.50



INSULATED CABLE CUTTER



				List Price
MBV444-8	38 mm ²	210	8	£43.00



INSULATED WATER PUMP PLIER



				List Price
MBV482-10Q	3-38	260	10	£50.90



INSULATED TOOLS



MECCA PRO INSULATED SCREWDRIVER & PLIER SET 18 PIECES



- » Insulated Side Cutting Plier 160 mm
- » Insulated Side Cutting Plier 205 mm
- » Insulated Combination Plier 200 mm
- » Insulated Long Nose Plier 215 mm
- » Insulated Wire Stripping Plier
- » Flat Insulated Screwdriver
 - 0.4×2.5, 0.5×3.0, 0.8×4.0, 1.0×5.5, 1.2×6.5
- » PH Insulated Screwdriver
 - PH0, PH1, PH2, PH3
- » PZ Insulated Screwdriver
 - PZ0, PZ1, PZ2, PZ3



TV18N

£429.90



3/8" INSULATED RATCHET

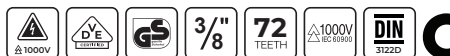

MV3800

3/8"

Twist

200

343 g

£104.90



3/8" INSULATED EXTENSION BAR

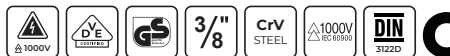

MV380020

3/8"

75

3

77 g

£25.50

MV380021

3/8"

150

6

135 g

£32.30



3/8" INSULATED SOCKET



		(mm)	1 (mm)	2 (mm)		
MV380506	6 mm	46	14.8	23	29 g	£17.40
MV380507	7 mm	46	15.7	23	29 g	£17.40
MV380508	8 mm	46	17	23	30 g	£17.40
MV380509	9 mm	46	18.2	23	31 g	£17.40
MV380510	10 mm	46	19.4	23	31 g	£17.40
MV380511	11 mm	46	20.7	23	32 g	£17.40
MV380512	12 mm	46	23	23	33 g	£17.40
MV380513	13 mm	46	23	23	37 g	£17.40
MV380514	14 mm	46	24.7	23	39 g	£18.00
MV380515	15 mm	46	26	23	40 g	£18.90
MV380516	16 mm	46	26.8	23	42 g	£18.90
MV380517	17 mm	46	29	23	47 g	£18.90
MV380518	18 mm	46	29.6	23	49 g	£18.90
MV380519	19 mm	46	30.7	23	53 g	£18.90
MV380520	20 mm	46	32.2	23	55 g	£20.10



INSULATED KNIFE



		(mm)		List Price
MKV709		21 mm	65 g	£19.90



REPLACEMENT BLADES FOR INSULATED KNIFE





		(mm)		List Price
MKV709A		21 mm	79 g	£27.50





INSULATED SPANNER



						
	mm	mm	mm	mm	g	
MPV600507	7 mm	88	17.8	6.7	18 g	£22.50
MPV600508	8 mm	104	23.0	7.6	33 g	£23.00
MPV600509	9 mm	401	23.0	7.6	33 g	£23.00
MPV600510	10 mm	114	25.0	8.1	37 g	£23.70
MPV600511	11 mm	124.3	29.5	8.8	57 g	£25.60
MPV600512	12 mm	124.3	29.5	8.8	57 g	£25.60
MPV600513	13 mm	154	34.0	10.3	95 g	£26.90
MPV600514	14 mm	154	34.0	10.3	95 g	£26.90
MPV600515	15 mm	171	42.0	11.0	123 g	£29.30
MPV600516	16 mm	171	42.0	11.0	123 g	£29.30
MPV600517	17 mm	171	42.0	11.0	123 g	£29.30
MPV600518	18 mm	182	46.6	12.0	148 g	£33.80
MPV600519	19 mm	182	46.6	12.0	148 g	£33.80
MPV600520	20 mm	202	52.0	13.0	215 g	£41.90
MPV600521	21 mm	202	52.0	13.0	215 g	£41.90
MPV600522	22 mm	202	52.0	13.0	215 g	£41.90
MPV600523	23 mm	237	57.0	14.0	319 g	£45.00
MPV600524	24 mm	237	57.0	14.0	319 g	£45.00



What are our insulated tools tested for?

- Insulation properties, i.e. resistance up to 1000 volts in dry or humid environments.
- Resistance to the cold, i.e. how well the tool withstands the cold
- Durability, i.e. that the insulating handles do not come loose
- Resistance to fire, i.e. how well the tool withstands fire
- Insulating properties under pressure, i.e. how well the tool maintains its insulating properties when subjected to pressure

C

Tools marked with the letter "C" according to IEC/EN 60900 have been tested for cold condition performance. This means the insulation has undergone additional testing at -20°C to ensure that the material remains safe, durable, and resistant to impact even in low-temperature environments.

A "C"-marked tool guarantees that:

- The insulation has been conditioned at low temperature.
- The tool has passed mechanical impact tests after cooling.
- The insulation continues to meet all electrical safety requirements.

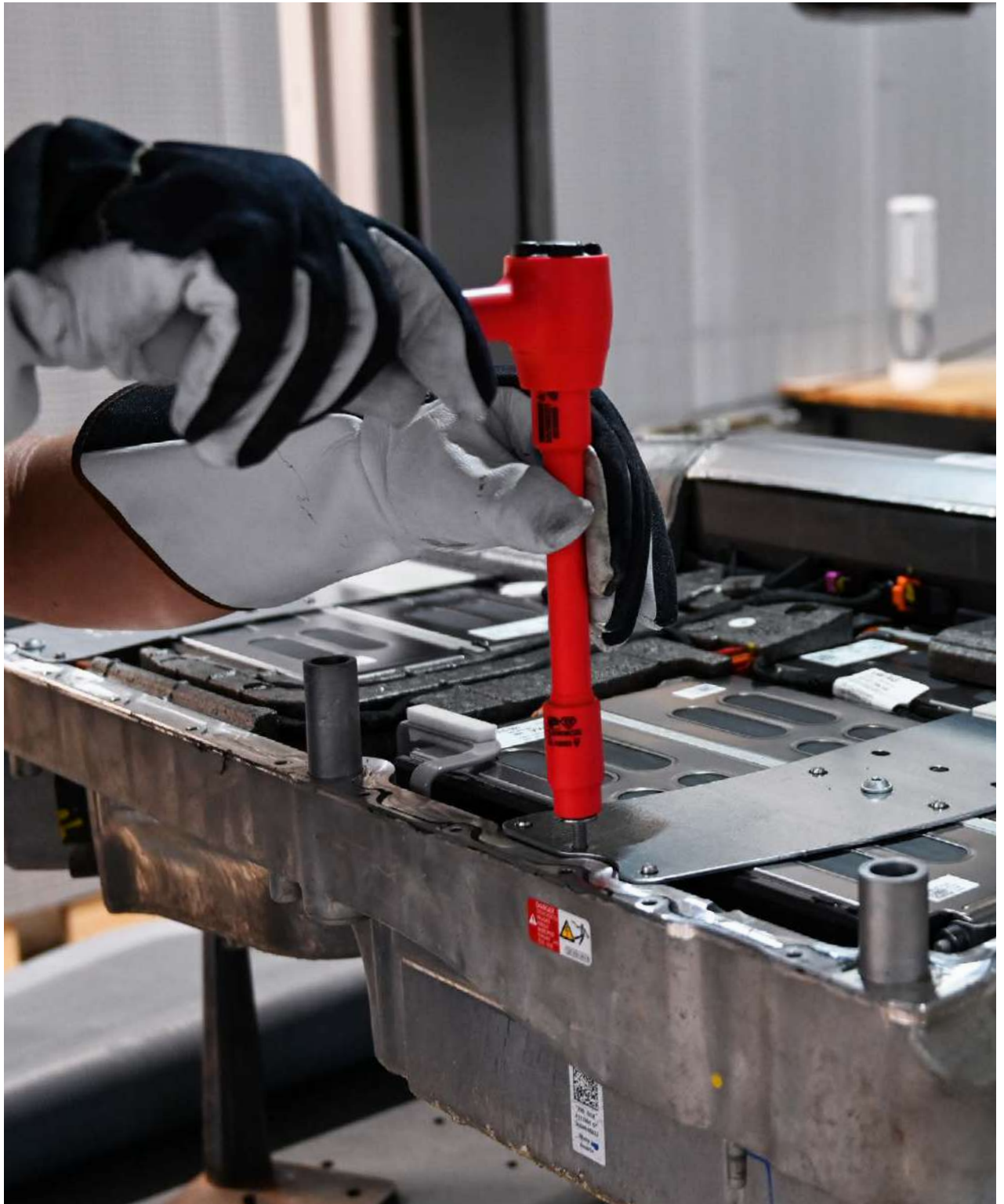

CUTTING TOOLS

PRECISION, PERFORMANCE, AND DURABILITY

From hacksaws and utility knives to precision snips and blades, each tool is engineered to deliver clean, accurate cuts with minimal effort. Designed for professional use across workshops, garages, and industry, TengTools cutting solutions combine ergonomic comfort with long-lasting sharpness — giving you the control and confidence to get the job done right, every time.





CUTTING TOOLS



TIN SNIP STRAIGHT



490	Straight	250	0.9 1.5	483 g	£31.80



TIN SNIP LEFT/STRAIGHT



492	Straight;Left	250	0.9 1.5	493 g	£31.80



TIN SNIP RIGHT/STRAIGHT



491	Straight;Right	250	0.9 1.5	508 g	£31.80



OFFSET TIN SNIP RIGHT/STRAIGHT



493	Right;Offset	250	0.9 1.5	533 g	£44.00



OFFSET TIN SNIP LEFT/STRAIGHT



494	Left;Offset	250	0.9	1.5	533 g £44.00



TIN SNIP HIGH LEVERAGE STRAIGHT



490W	Straight	250	0.9	1.5	408 g £32.40



LONG TIN SNIP



495	Straight;Long cut	275	0.5	0.9	443 g £35.90



TIN SNIP HIGH LEVERAGE RIGHT/STRAIGHT



491W	Straight;Right	250	0.9	1.5	388 g £32.40



CUTTING TOOLS



TIN SNIP HIGH LEVERAGE LEFT/STRAIGHT



492W

Straight;Left



250



0.9



1.5



393 g

£32.90



COMPACT TIN SNIP STRAIGHT/RIGHT CUT CR-MO 182MM



493-7N

Straight;Right



182



0.9



1.5



210 g

£37.60



COMPACT TIN SNIP STRAIGHT CUT CR-MO 190MM



491-7N

Straight



190



0.9



1.5



188 g

£37.60



COMPACT TIN SNIP STRAIGHT/LEFT CUT CR-MO 182MM



494-7N

Straight;Left



182



0.9



1.5



210 g

£37.60

- | | |
|------------------|----------------------|
| Piano Wire | Steel Wire |
| Hard Wire | Stainless Steel Wire |
| Medium Hard Wire | Spring Steel Wire |
| Soft Wire | Iron Wire |



Do's and Dont's of Hacksaws

DO'S

- **Use the right blade:** Choose the right blade for the material you are cutting. A fine-toothed blade for thin metal, and a coarse-toothed blade for thicker materials.
- **Wear protective gear:** Wear safety glasses and gloves to protect yourself from flying debris.
- **Use the correct technique:** Hold the saw with both hands and use long, smooth strokes. Avoid twisting or bending the blade.
- **Keep the saw blade lubricated:** Lubricate the saw blade with a light oil to reduce friction.
- **Store the saw properly:** Store the saw in a dry place with the blade covered.

DONT'S

- **Force the saw:** Do not apply excessive pressure on the saw, as this can damage the blade or cause it to break.
- **Use a dull blade:** Do not use a dull blade, as this can cause the saw to become stuck or make rough cuts.
- **Twist or bend the blade:** Do not twist or bend the blade while cutting, as this can cause it to break or become damaged.
- **Use the wrong blade:** Do not use the wrong blade for the material you are cutting, as this can cause the blade to wear down quickly or break.
- **Ignore safety gear:** Do not forget to wear protective gear such as safety glasses and gloves, as this can increase your risk of injury.



3

PCS

HACKSAW AND KNIFE SET 24TPI METAL



- » Hacksaw 24TPI Metal
- » Mini Hacksaw 24TPI Metal
- » Utility Knife





700-PROS

£64.40





HACKSAW ERGONOMIC HANDLE 24TPI METAL

					
		(mm)			
701N1	Aluminum, High Speed Steel	300	24 Metal TPI	588 g	£45.40
702	Replacement Blade Hacksaw 24TPI Metal	300		35 g	£13.30





HACKSAW 24TPI METAL

					
		(mm)			
701	Aluminum, High Speed Steel	300	24 Metal TPI	572 g	£39.70
702	Replacement Blade Hacksaw 24TPI Metal	300		35 g	£13.30



FOLDING UTILITY SAW

					
		(mm)			
703A	24 Metal; 10 Wood/Plastic TPI	150		184 g	£45.10
703-10	Replacement Blade Gun Saw 10TPI Wood/Plastic	300		42 g	£11.70



CUTTING TOOLS

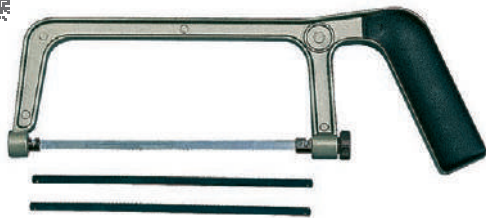

MINI HACKSAW 24TPI METAL

	 (mm)			
705	150	24 Metal TPI	126 g	£14.60
	 (mm)			
705-5	150	Replacement Blade Mini Hacksaw 24TPI Metal	13 g	£8.40



HACKSAW BLADE HOLDER 24TPI METAL

	 (mm)			
704	300	24 Metal TPI	112 g	£13.80
	 (mm)			
702	300	Replacement Blade Hacksaw 24TPI Metal	35 g	£13.30



MINI HACKSAW 24TPI METAL/16TPI WOOD

705A		24 Metal; 16 Wood TPI	193 g	£20.00
705A-5		Replacement Blade Mini Hacksaw 16TPI Wood	7 g	£9.60



28
PCS

DIN
338

DRILL BIT SET 1.0-10.0 MM 28 PIECES

»	1 (×4), 1.5 (×3), 2 (×2), 2.5, 3, 3.3, 3.5, 4, 4.2, 4.5, 5, 5.5, 6, 6.5, 6.8, 7, 7.5, 8, 8.5, 9, 9.5, 10
DB028	£104.90



DRILL BIT SET 1.0-13.0 MM 34 PIECES

»	
	1 (×4), 1.5 (×3), 2 (×2), 2.5, 3, 3.3, 3.5, 4, 4.2, 4.5, 5, 5.5, 6, 6.5, 6.8, 7, 7.5, 8, 8.5, 9, 9.5, 10, 10.5, 11, 11.5, 12, 12.5, 13
DB034	£210.90



DRILL BITS FULLY GROUND 1.0MM ×10

				
		(mm)		
DBX010	1 mm	34	10	£5.50
DBX015	1.5 mm	40	10	£6.20
DBX020	2 mm	49	10	£6.80
DBX025	2.5 mm	57	10	£7.60
DBX030	3 mm	61	10	£13.40
DBX033	3.3 mm	65	10	£15.90
DBX035	3.5 mm	70	10	£15.90
DBX040	4 mm	75	10	£17.20
DBX042	4.2 mm	75	10	£21.70
DBX045	4.5 mm	80	10	£21.70
DBX050	5 mm	86	10	£25.60
DBX055	5.5 mm	93	10	£35.30
DBX060	6 mm	93	10	£39.40
DBX065	6.5 mm	101	10	£44.30
DBX068	6.8 mm	109	10	£52.40
DBX070	7 mm	109	10	£52.40
DBX075	7.5 mm	109	10	£61.30
DBX080	8 mm	117	5	£39.70
DBX085	8.5 mm	117	5	£42.80
DBX090	9 mm	125	5	£50.30
DBX095	9.5 mm	125	5	£55.40
DBX100	10 mm	133	5	£64.90
DBX105	10.5 mm	133	5	£71.00
DBX110	11 mm	142	5	£81.90
DBX115	11.5 mm	142	5	£89.40
DBX120	12 mm	151	5	£102.60
DBX125	12.5 mm	151	5	£111.90
DBX130	13 mm	151	5	£120.00



CUTTING TOOLS



TAP



Part No.	Size	Material	Weight	Price
TDT03050	M3 × 0.5	58 HRC	4 g	£8.00
TDT04070	M4 × 0.7	58 HRC	5 g	£8.00
TDT05080	M5 × 0.8	58 HRC	8 g	£8.00
TDT06100	M6 × 1.0	58 HRC	10 g	£8.00
TDT08125	M8 × 1.25	58 HRC	20 g	£8.30
TDI10150	M10 × 1.5	58 HRC	22 g	£8.70
TDI12175	M12 × 1.75	58 HRC	25 g	£8.70



DIE



Part No.	Size	Material	Length	Weight	Price
TDD03050	M3 × 0.5	58 HRC	25 mm	21 g	£11.50
TDD04070	M4 × 0.7	58 HRC	25 mm	20 g	£11.50
TDD05080	M5 × 0.8	58 HRC	25 mm	22 g	£11.50
TDD06100	M6 × 1.0	58 HRC	25 mm	24 g	£11.50
TDD08125	M8 × 1.25	58 HRC	25 mm	15 g	£11.50
TDD10150	M10 × 1.5	58 HRC	25 mm	21 g	£11.50
TDD12175	M12 × 1.75	58 HRC	25 mm	19 g	£11.50



1/4" DIE CHUCK M3 - M12



Part No.	Size	Weight	Price
M140070	M3 - M12	90 g	£34.40



1/4" TAP CHUCK



Part No.	Size	Length	Weight	Price
M140071	M3 - M8	20 mm	52 g	£19.10
M140072	M5 - M12	25 mm	85 g	£24.10



TAP HANDLE M3 - M12



TAP-HNDL

M3 - M12



127 g

£15.90



DIE HANDLE M3 - M12



DIE-HNDL

M3 - M12



127 g

£16.40



SNAP OFF KNIFE SET 4 PIECES



- » Snap Off Knife Knife 9 mm Metal Casing
- » Snap Off Knife 18 mm Plastic Housing
- » Snap Off Knife Knife 9 mm Plastic Housing
- » Snap Off Knife 18 mm Plastic Housing Lock



710S

£24.90



SNAP OFF KNIFE KNIFE 9MM METAL CASING



710A



9 mm



12 g

£6.00



CUTTING TOOLS



SNAP OFF KNIFE KNIFE 9MM PLASTIC HOUSING LOCK



710H

9 mm

9 g

£3.20



SNAP OFF KNIFE 18MM PLASTIC HOUSING LOCK



710G

18 mm

74 g

£11.80



SNAP OFF KNIFE KNIFE 9MM PLASTIC HOUSING



710F

9 mm

26 g

£6.00

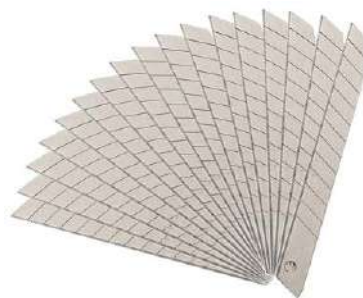

REPLACEMENT SNAP OFF BLADES 9MM



710A-10

Replacement Snap Off Blades
9mm 10 pcs

23 g

£4.60

710A-100

Replacement Snap Off Blades
9mm 100 pcs

211 g

£37.60



SNAP OFF KNIFE 18MM PLASTIC HOUSING



710C

18 mm

38 g

£6.00



REPLACEMENT SNAP OFF BLADES 18MM



710F-10

Replacement Snap Off Blades
18mm 10 pcs

68 g

£6.20



MINI FOLDING UTILITY KNIFE

P-UKF	9 mm	28 (mm)	62 g	£14.00	
710U-10	Replacement Blades Mini Folding Utility Knife 10 pcs		10 g	£5.00	



SAFETY UTILITY KNIFE

711	19 mm	60 (mm)	Yes	230 g	£29.00



QUICK ACTION UTILITY KNIFE

710N	19 mm	60 (mm)	167 g	£20.40	



FOLDING UTILITY KNIFE

712	19 mm	60 (mm)	202 g	£31.40	



CUTTING TOOLS



UTILITY KNIFE



710



19 mm



60
(mm)



104 g

£10.90

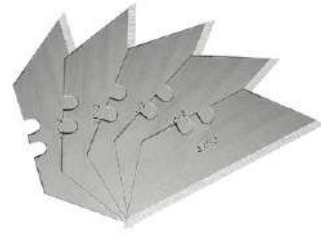

REPLACEMENT BLADES UTILITY KNIFE



710-10

Replacement Blades Utility Knife
10 pcs



47 g

£7.80

REPLACEMENT HOOK BLADES UTILITY KNIFE



710-100H

Replacement Hook Blades Utility
Knife 100 pcs





365 g

£122.90





NEEDLE FILE FLAT

					
TTNF12-01	Flat	160	Vinyl	15 g	£5.60





NEEDLE FILE SQUARE

					
TTNF12-04	Square	160	Vinyl	15 g	£5.60





NEEDLE FILE HALF ROUND

					
TTNF12-02	Half round	160	Vinyl	15 g	£5.60





NEEDLE FILE ROUND

					
TTNF12-05	Round	160	Vinyl	15 g	£5.60





NEEDLE FILE TRIANGULAR

					
TTNF12-03	Triangular	160	Vinyl	15 g	£5.60



NEEDLE FILE FLAT POINT

					
TTNF12-06	Flat point	160	Vinyl	15 g	£5.60



CUTTING TOOLS



NEEDLE FILE KNIFE TYPE



TTNF12-07	Knife type	160	Vinyl	15 g	£5.60
-----------	------------	-----	-------	------	-------



NEEDLE FILE OVAL



TTNF12-10	Oval	160	Vinyl	15 g	£5.60
-----------	------	-----	-------	------	-------



NEEDLE FILE BARRETTE



TTNF12-08	Barrette	160	Vinyl	15 g	£5.60
-----------	----------	-----	-------	------	-------



NEEDLE FILE FEATHER



TTNF12-11	Feather	160	Vinyl	15 g	£5.60
-----------	---------	-----	-------	------	-------



NEEDLE FILE CROSSING



TTNF12-09	Crossing	160	Vinyl	15 g	£5.60
-----------	----------	-----	-------	------	-------



NEEDLE FILE ROUND EDGE FLAT



TTNF12-12	Round edge flat	160	Vinyl	15 g	£5.60
-----------	-----------------	-----	-------	------	-------



HAND FILE 250MM FLAT



FLFT10 Flat 250 Bi-material 287 g £16.70



HAND FILE 250MM ROUND



FLRD10 Round 250 Bi-material 190 g £16.00



HAND FILE 250MM FLAT TAPERED



FLHF10 Flat 250 Bi-material 289 g £16.70



HAND FILE 250MM TRIANGULAR



FLTR10 Triangular 250 Bi-material 268 g £17.00



HAND FILE 250MM HALF ROUND



FLHR10 Half round 250 Bi-material 290 g £17.50



MEASURING TOOLS

ACCURACY IS KEY

Our range of Measuring Tools have been developed by focusing on TengTools users requirements across the automotive & industrial sectors. All tools are available individually but are also available in the unique TengTools TT trays so you can add them to your existing tool kit or include them when you are building your ultimate tool kit.



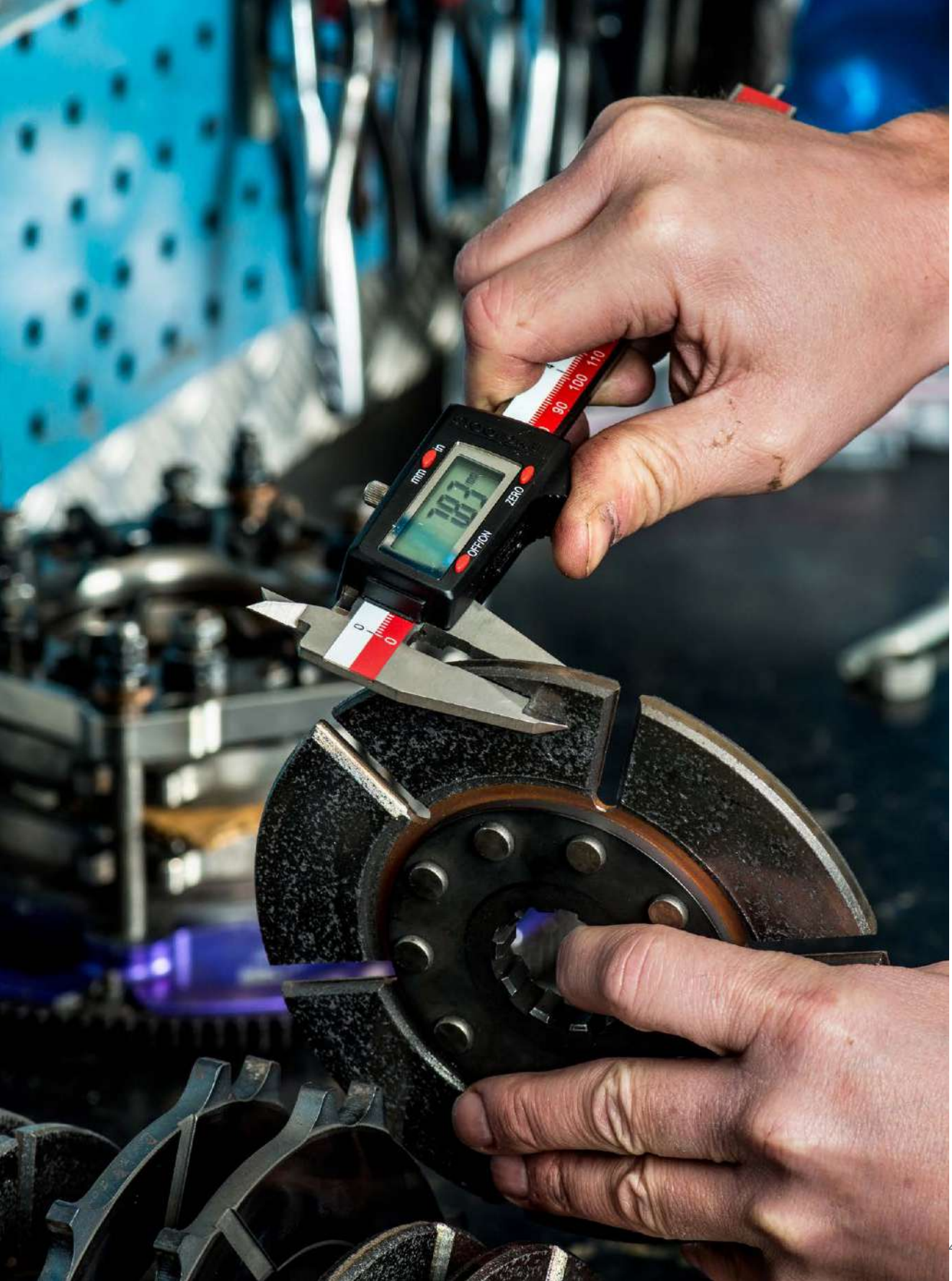

MEASURING TOOLS



MICROMETER 0 - 25MM



- Friction thimble and locking nut for easy operation
- Forged frame with hardened steel and polished measuring surfaces
- Matt chrome plated scale for easy reading
- Supplied with a plastic storage case
- Designed and manufactured to DIN863

MIR25	0 - 25	25	0.01	± 0.004 mm	197 g	£52.40



VERNIER CALLIPER 0-150MM



- 4 function calliper to measure height, width, depth and step
- Metric and inch scales with 0.05mm and 1/128" scales
- Frosted chrome plated scale for easier reading
- Stainless steel construction with lapped edges
- Supplied with a plastic storage case
- Designed and manufactured to DIN862

CALV150	0-150	40	0.05	143 g	£46.20	



DIGITAL CALLIPER 0-150MM



- 4 function calliper to measure height, width, depth and step
- Adjustable between mm and inches
- Reset button and zero set in any position
- Automatic switch off to conserve batteries
- 0.01mm reading scale with 10mm high figures
- Uses CR2032 batteries (supplied)
- Supplied with a plastic storage case
- Designed and manufactured to DIN862



CALD150	0-150	40	0.01	166 g	£78.10	



FEELER GAUGE

mm

- Blades for measuring from 0.05mm to 1.0mm
- Hardened rolled steel for durability and accuracy
- Fold up case with tightening screw for easy storage

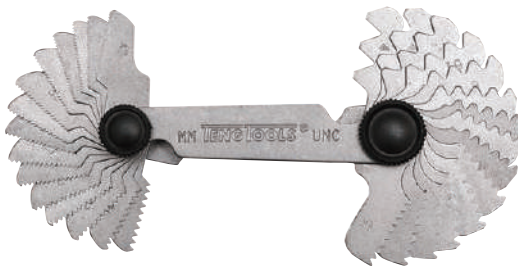

	#	(mm)	(mm)		
FG13100	13	0,05-1,0	100	52 g	£6.90
FG20100	20	0,05-1,0	100	88 g	£9.10
FG20200	20	0,05-1,0	200	206 g	£23.30



GAUGE THREAD MM/UNC 0,25-6,0MM

mm
UNC

- 54 blades in a handy holder with tightening screws
- Thread gauge 60°
- Suitable for measuring metric and UNC threads
- Manufactured from #45 steel for a long lasting gauge



	#	(mm)	(UNC)		
TGMUNC	54	0.25-6.0	4-42	67 g	£23.20



DIAL GAUGE WITH MAGNETIC STAND 0-10 MM

mm

- Aluminium dial indicator
- 57mm diameter dial with a turnable scale and two tolerance indexes
- An extra pointer indicates whole millimetres to make measurements simple
- The stand has central locking
- A strong magnet in the base to hold the stand in place when in use



	(mm)			
DGMM	0-10	0.01	1662 g	£129.00



STEEL RULE

mm AF

- Stainless steel to avoid corrosion
- Hanging hole for easy storage

	(mm)	(mm)		
ST200	200 mm	20	0.8 mm	27 g £11.0
STMM1150	150 mm	20	0.8 mm	13 g £5.70





MEASURING TAPE METRIC/INCH

mm AF

- mm and inches for international use
- ABS case for durability
- Rubberised grip for a more secure grip especially when wet or oily
- Tape lock and belt clip for secure storage when being used
- Power return tape for automatic rewinding
- Aligning hook for internal/external measurements
- Designed and manufactured to Cat II

			(mm)		
MT03	3 m	10 ft	13	91 g	£9.30
MT05	5 m	16 ft	19	187 g	£14.10
MT08	8 m	26 ft	25	370 g	£27.30



MEASURING TAPE METRIC

mm







- Graduated in mm only
- ABS case for durability
- Rubberised grip for a more secure grip especially when wet or oily
- Tape lock and belt clip for secure storage when being used
- Power return tape for automatic rewinding
- Aligning hook for internal/external measurements
- Designed and manufactured to Cat II

			(mm)		
MT03MM	3 m		13	91 g	£9.30
MT05MM	5 m		19	187 g	£14.10
MT08MM	8 m		25	370 g	£27.30









TORPEDO SPIRIT LEVEL

- Magnetic aluminium "torpedo" spirit level
- 3 magnets on the underside help fix the level to ferrous work pieces
- One horizontal, one vertical and one 45° angled vials
- Crush proof, durable vials with high transparency for easy reading
- Highly resistant to ultra violet light and fluctuations in temperature
- Shock absorbent end protectors to reduce the risk of damage
- Temperature proof vial mountings to reduce the risk of distortion

	 (mm)	 (mm)	 (mm)			
SLT01	230	16	38	±1,0mm/m	144 g	£38.60

SPIRIT LEVEL MAGNETIC

- Magnets on the underside help fix the level to ferrous work pieces
- Crush proof, durable vials with high transparency for easy reading
- Highly resistant to ultra violet light and fluctuations in temperature
- Shock absorbent end protectors to reduce the risk of damage
- Temperature proof vial mountings to reduce the risk of distortion

	 (mm)	 (mm)	 (mm)			
SLM0300	300	24	50	±0,75mm/m	330 g	£86.80
SLM0400	400	24	50	±0,75mm/m	368 g	£87.10
SLM0600	600	24	50	±0,75mm/m	467 g	£98.60
SLM1000	1000	24	50	±0,75mm/m	834 g	£118.90
SLM1200	1200	24	50	±0,75mm/m	893 g	£153.80





SLIDING BEVEL

- Check edges for consistency by sliding the edge over the material
- Duplicate angles for marking by setting the adjustable blade
- Straight and true stainless steel blade for accuracy
- Plastic stock for reduced weight and a better grip

AB200	200	25	72 g	£10.70

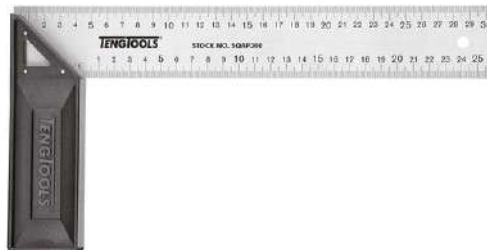

TRY SQUARE

mm

- Stainless steel blade with an anodised aluminium stock
- Blade measures 1.5 x 45mm with the stock being 18mm wide
- Milled working surface with deep etched markings
- Highly resistant to wear

SQAA200	200	± 0.03 mm	224 g	£37.60
SQAA250	250	± 0.03 mm	249 g	£39.90
SQAA300	300	± 0.03 mm	275 g	£45.00



SQUARE BASE

mm

- Zinc plated for corrosion resistance
- Base square design enables the square to be sat on a work surface



SQAB10070	100 × 70	163 g	£22.60
SQAB150100	150 × 100	315 g	£32.00
SQAB200130	200 × 130	694 g	£46.80
SQAB300175	300 × 175	1205 g	£92.20

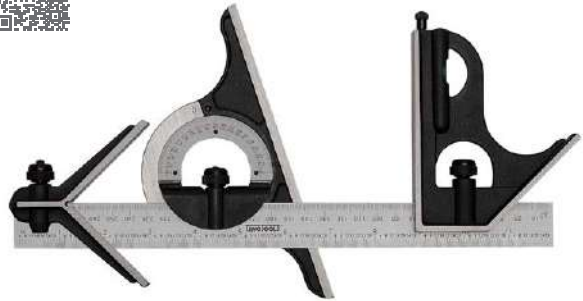

COMBINATION SQUARE 300MM

- For measuring and checking angles
- Graduated in mm and inches for universal use
- 300mm steel rule with a reversible protractor, adjustable angle ledge and centre head
- Angle ledge and protractor both include a spirit level



SQAC300	0-180°	300	110	63	1234 g	£153.90
---------	--------	-----	-----	----	--------	---------



Scan the QR code
to contact us or
request a call back



McKinsey
& Connors
RNZYS



AUTO TOOLS

ESSENTIALS FOR ANY GARAGE

When working on motors and general servicing it is vital that you have the right tools ready when you are. Whether it is a spark plug socket or hose clamps you need tools that are great to work with and bring better results.





AUTO TOOLS



COTTER PIN PULLER



MDH-S 90° 245 Bi-material 107 g £10.10



GASKET SCRAPER 22MM



MD-SCR 245 Bi-material 134 g £20.60



HOOK TOOL CURVED



MDH-L 200 Bi-material 98 g £9.70



AWL STRAIGHT



MDA180 164 Bi-material 27 g £6.60



AWL ROUND TIP



MDA-R 245 Bi-material 98 g £9.70



COTTER PIN PULLER S



MDP90 90° 164 Bi-material 27 g £6.60



HOOK TOOL 35°

MDP35	35°	164	Bi-material	27 g	£6.60



TRIM CLIP REMOVAL TOOL V-SHAPE

MRP06	208	Bi-material	66 g		£10.40



HOOK TOOL 125°

MDP125	125°	164	Bi-material	27 g	£6.60



PANEL CLIP REMOVAL TOOL U-SHAPE LARGE

MDR08	231	Bi-material	121 g		£14.60



TRIM CLIP REMOVAL TOOL V-SHAPE LARGE

MRP95	226	Bi-material	144 g		£15.80





PANEL CLIP REMOVAL TOOL U-SHAPE

MDR06	223	Bi-material	75 g		£11.30





HOSE CLAMP

	 (mm)	mm	AF		
AT080	157	6 - 19	1/4 - 3/4"	43 g	£16.10
AT085	185	6 - 32	1/4 - 1-1/4"	74 g	£17.90
AT090	253	19 - 57	3/4 - 2-1/4"	125 g	£23.10



HOSE CLIP DRIVER 7MM



- Fits most commonly used worm drive hose clips such as Jubilee® hose clips
- Flexible shaft for easier access in confined spaces

			
MD503NA	7 mm	146 g	£14.20



HOSE CLIP DRIVER 6MM/7MM



- Fits most commonly used worm drive hose clips such as Jubilee® hose clips
- Flexible shaft for easier access in confined spaces

			
MD503N	6 x 7 mm	160 g	£16.90



HOSE CLIP DRIVER 8MM

- Fits most commonly used worm drive hose clips such as Jubilee® hose clips
- Flexible shaft for easier access in confined spaces

			
MD503ND	8 mm	147 g	£14.00



3/8" SPARK PLUG SOCKET

3/8"

				(mm)	(mm)								
M380039-C				14 mm	3/8"	17	64	19.5	M8				£9.30
M380040-C				16 mm	3/8"	19	64	21.3	M10				£8.00
M380041-C				16 mm	3/8"	Yes	85	21.8	M10				£20.10
M380042-C				18 mm	3/8"	19	70	23.3	M12				£8.80
M380046-C				21 mm	3/8"	22	70	27.8	M14				£9.40
M380047-C				21 mm	3/8"	Yes	91	27.8	M14				£20.00

1/2"

				(mm)	(mm)								
M120040-C				16 mm	1/2"	19	70	21.5	M10				£9.60
M120042-C				18 mm	1/2"	22	70	24.4	M12				£10.40
M120046-C				21 mm	1/2"	24	70	27.8	M14				£11.90



SPARK PLUG BOOT PLIER

				(mm)									
SPBP20				250				215 g					£23.80



3/8" T-BAR SPARK PLUG SOCKET

3/8"

				(mm)	(mm)								
TBUSP14				14 mm	3/8"	Yes	60	18.8	400 g				£42.80
TBUSP16				16 mm	3/8"	Yes	60	21.8	445 g				£43.00
TBUSP21				21 mm	3/8"	Yes	60	27.8	485 g				£44.50



SPARK PLUG THREAD CLEANER

TRC1012				10 x 12 mm			10 x 1 12 x 1,25	400 g					£42.80
TRC1418				14 x 18 mm			14 x 1,25 18 x 1,5	445 g					£43.00





OIL FILTER REMOVAL TOOL STRAP TYPE 160MM

9123	160	230	316 g	£9.70



1/2" OIL FILTER REMOVAL TOOL STRAP TYPE 130MM

9110	1/2"	130	125 g	£12.00



OIL FILTER REMOVAL PLIER 53 - 118MM

	409	53 - 118	425 g	£34.90



1/2" OIL FILTER REMOVAL TOOL CHAIN TYPE 120MM

9120	1/2"	120	223 g	£13.40



1/2" HEAVY DUTY OIL FILTER REMOVAL TOOL

1/2"



(mm)



9120HD 1/2" 150 521 g £36.90



ADJUSTABLE ENGINE CYLINDER HONING TOOL 50 - 180MM



(mm)



AT040 50-180 338 g £50.30



DRAIN PLUG



(mm)



Part No.	Size	Length (mm)	Weight (g)	Price (£)
DP0810	8 x 10 mm	52	82 g	£15.00
DP0812	8 x 3/8	52	82 g	£15.00
DP1012	5/16 x 3/8 in	52	81 g	£15.00
DP1112	11 mm	52	91 g	£15.00
DP1314	13 mm	52	107 g	£15.00
DP1716	17 x 1/2	52	112 g	£15.00



ADJUSTABLE BRAKE CYLINDER HONING TOOL 20 - 68MM



AT180 20-68 mm 80 g £16.80





BALL JOINT SEPERATOR



AT191	0 - 60 mm	29 mm	881 g	£101.80
AT192	0 - 80 mm	40 mm	1540 g	£133.70



SPECIAL AUTO SOCKETS



AT350	29 mm	1/2" Lambda Oxygen Sensor Sockets Straight 29 mm	504 g	£34.70
AT355	22 mm	3/8" Lambda Oxygen Sensor Sockets 22 mm	218 g	£24.40
AT360	27 mm	1/2" Fuel Injector Socket	221 g	£26.70
AT365	7/8 in	3/8" Vacuum Switch Socket 7/8"	227 g	£25.10
AT370	11/16 in	3/8" Oil Pressure Sender Socket 11/16"	215 g	£20.90
AT375	7/8 in	1/2" Heated Lambda Oxygen Sensor Sockets 7/8"	177 g	£26.70
AT380	7/8 in	3/8" Lambda Oxygen Sensor Sockets Offset 7/8"	222 g	£27.70



1/2" IMPACT SOCKET WHEEL NUT SET 3 PIECES



»	17, 19, 21
9203N	£58.10



TYRE LEVER



AT20512	300	12	291 g	£23.00
AT20516	400	16	486 g	£36.60
AT20520	500	20	640 g	£44.00
AT20524	600	24	824 g	£57.50



BICYCLE KEY SET 11 PIECES



» 1.0 x 5.5, PH2, TX25, TX30, HEX4, HEX5, HEX6, Tyre lever, Chain repair tool



9203N £58.10



1/2" DOUBLE ENDED IMPACT SOCKET SET



» 1/2" Impact Extension Bar DIN (F) ANSI (M) 75 mm
 » 1/2" Double Ended Impact Socket Metric
 » 17x19, 21x22



9203N1 £32.40



1/2" WHEEL WRENCH



» 17 x 19 mm 1/2" 35-55 928 g £31.40



1/2" IMPACT SOCKET WHEEL NUT



	■	(mm)	⚖️	
920517N	17 mm	1/2"	85	272 g £20.00
920519N	19 mm	1/2"	85	254 g £20.00
920521N	21 mm	1/2"	85	265 g £20.80





WING COVER

FC01	PVC	1070 (mm)	400 (mm)	730 g	£77.10



SUCTION LIFTER

SL03	MAX	180 mm	916 g	£121.30



SUCTION LIFTER

SL02	MAX	118 mm	607 g	£80.50



DOLLY CURVED

					List Price
AT415	128 (mm)	58 (mm)	40 (mm)	1151 g	£48.20



**BODY WORKING HAMMER ROUND CROWN FACE/
STRAIGHT PEIN**

HMBH01	32.5 mm	325 (mm)	Hickory	419 g	£42.60



DEAD BLOW HAMMER

HMDH35	35 mm	345 g	£31.80
HMDH45	45 mm	500 g	£46.00
HMDH55	55 mm	1010 g	£51.30
HMDH65	65 mm	1505 g	£69.80



**BODY WORKING HAMMER ROUND CROWN FACE/
POINT PIN**

HMBH02	32.5 mm	325 (mm)	Hickory	406 g	£43.00



DEADBLOW HAMMER PU

HMDH50PU	50 mm	711 g	£71.30
HMDH60PU	60 mm	1168 g	£76.40
HMDH70PU	70 mm	1600 g	£97.80



**BODY WORKING HAMMER ROUND CROWN FACE/
SQUARE MILLED**

HMBH03	32.5 mm	325 (mm)	Hickory	468 g	£50.90



SERVICE TOOLS



TWO/THREE ARM GEAR PULLER 100MM



(mm)



SP11

89

1223 g

£120.00



TWO/THREE ARM GEAR PULLER 175MM



(mm)



SP22

137

2612 g

£232.00

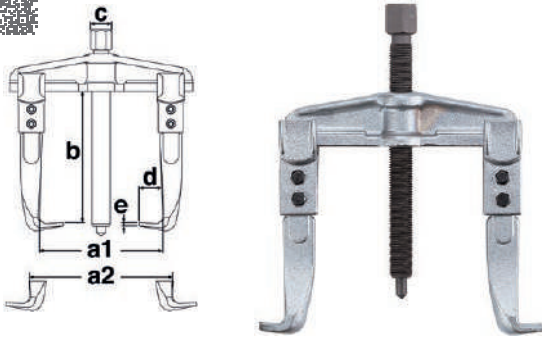

TWO ARM UNIVERSAL PULLER

		a1	a2	b	c	d	e		
		(mm)	(mm)	(mm)	(mm)	(mm)	(mm)		
SP1410	M14 x 1,5	140	90	130	100	17	12	3.4	1065 g £127.40
SP1810	M14 x 1,5	140	130	170	100	17	12	3.4	1175 g £134.60
SP2215	M20 x 2,0	210	160	220	150	22	20	3.8	2983 g £220.00
SP2615	M20 x 2,0	210	200	256	150	22	20	3.8	3358 g £245.00
SP3320	M26 x 2,0	280	250	325	200	27	27	6.2	6931 g £439.00

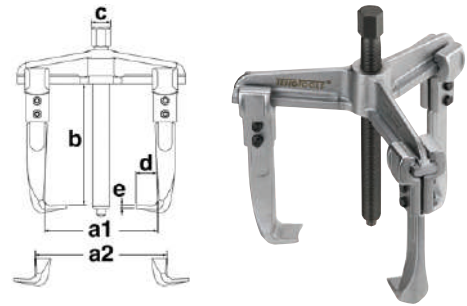

THREE ARM UNIVERSAL PULLER

		a1	a2	b	c	d	e		
		(mm)	(mm)	(mm)	(mm)	(mm)	(mm)		
SP31410	M14 x 1,5	140	90	140	100	17	12	3.4	1425 g £203.00
SP31810	M14 x 1,5	140	130	180	100	17	12	3.4	1564 g £218.00
SP32215	M20 x 2,0	210	160	220	150	22	20	3.8	3868 g £315.00
SP32615	M20 x 2,0	210	205	260	150	22	20	3.8	4121 g £324.00
SP33320	M26 x 2,0	280	252	330	200	27	27	6.2	8571 g £478.00

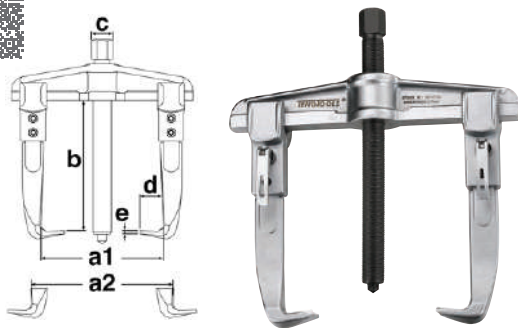

TWO ARM QUICK ACTION PULLER

		a1	a2	b	c	d	e		
		(mm)	(mm)	(mm)	(mm)	(mm)	(mm)		
SP1410Q	M14 x 1,5	140	90	130	100	17	12	3.4	1093 g #REF!
SP1810Q	M14 x 1,5	140	130	170	100	17	12	3.4	1208 g £178.00
SP2215Q	M20 x 2,0	210	160	220	150	22	20	3.8	3023 g £263.00
SP2615Q	M20 x 2,0	210	200	256	150	22	20	3.8	3421 g £298.00
SP3320Q	M26 x 2,0	280	250	325	205	27	27	6.2	6920 g £428.00

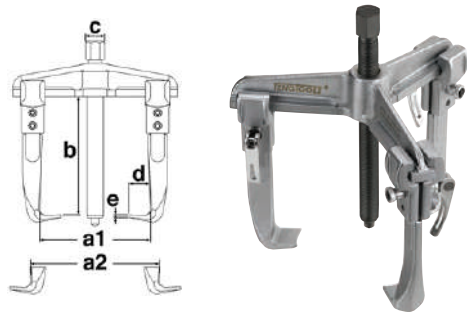

THREE ARM QUICK ACTION PULLER

		a1	a2	b	c	d	e		
		(mm)	(mm)	(mm)	(mm)	(mm)	(mm)		
SP31410Q	M14 x 1,5	140	90	140	100	17	12	3.4	1498 g £241.00
SP31810Q	M14 x 1,5	140	130	180	100	17	12	3.4	1637 g £251.00
SP32215Q	M20 x 2,0	210	160	220	150	22	20	3.8	3958 g £338.00
SP32615Q	M20 x 2,0	210	205	260	150	22	20	3.8	4232 g £424.00
SP33320Q	M26 x 2,0	280	252	330	205	27	27	6.2	8781 g £526.00

SERVICE TOOLS



5

PCS

PULLER SET WITH STAND



90/130mm spread, 130/170mm spread, 160/220mm spread,
200/256mm spread, 250/325mm spread



DIS-SP05

£1,189.00



CrMo
STEEL



SCREW EXTRACTOR



		(mm)	(mm)		
TEP65508	8 mm	65	12.3	25 g	£12.10
TEP65510	10 mm	65	15.5	31 g	£12.90
TEP65511	11 mm	65	16.4	32 g	£13.70
TEP65512	12 mm	65	18.2	33 g	£13.70
TEP65513	13 mm	65	18.5	34 g	£14.90



1/4" SCREW EXTRACTOR



		(mm)		
SE141	1	50	12 g	£3.80
SE142	2	50	12 g	£3.80
SE143	3	50	12 g	£3.80



CrV
STEEL



SCREW EXTRACTOR



SEL01S	1	3 mm	6 g	£4.60
SEL02S	2	4 mm	9 g	£5.00
SEL03S	3	5 mm	19 g	£6.90
SEL04S	4	7 mm	23 g	£8.00
SEL05S	5	9 mm	48 g	£8.90



5
PCS

SCREW EXTRACTOR SET WITH BELT CLIP 5 PIECES



» 1, 2, 3, 4, 5



TJSE055

£30.20



2
PCS

NUT SPLITTER SET 2 PIECES

- » Simply tighten the thread to engage the blade and split stubborn nuts
- » Capacities 5 to 20mm and 14 to 27mm



NS02

£38.70



5
PCS

SCREW EXTRACTOR SET SPIRAL 5 PIECES



SE05

£24.20





1/2" CrV STEEL

1/2" STUD EXTRACTOR SOCKET



Part No.	Size	Weight	Price
ST12506-C	6 mm	131 g	£18.90
ST12508-C	8 mm	129 g	£19.70
ST12510-C	10 mm	185 g	£22.10
ST12512-C	12 mm	182 g	£23.50



1/2"

1/2" STUD EXTRACTOR ECCENTRIC

- » For inserting and extracting stud bolts
- » One eccentric knurled contact wheel grips the stud against an internal fluting
- » Suitable for use with stud bolts from 5.5 to 19mm diameter thread



Part No.	Price
2300	£56.90



3/8"

3/8" STUD EXTRACTOR



Part No.	Size	Hex (mm)	Length (mm)	Weight	Price
ST38112	3/8 in	15.9	27	22 g	£30.00
ST38116	1/2 in	19	27	33 g	£35.10
ST38122	11/16 in	25.4	27	70 g	£36.80
ST38306	6 mm	15.9	27	17 g	£29.90
ST38308	8 mm	15.9	27	19 g	£29.90
ST38310	10 mm	19	27	24 g	£31.10
ST38311	11 mm	19	27	30 g	£32.80
ST38312	12 mm	19	27	32 g	£33.50
ST38313	13 mm	19	27	34 g	£35.10
ST38314	14 mm	22.2	27	50 g	£35.60
ST38316	16 mm	22.2	27	50 g	£36.20
ST38317	17 mm	25.4	27	74 g	£36.70

1/2"





1/2" STUD EXTRACTOR



Part No.	Size	Hex (mm)	Length (mm)	Weight	Price
ST12319	19 mm	27	44.5	162 g	£51.40
ST12321	21 mm	32	44.5	199 g	£54.50
ST12322	22 mm	35	44.5	209 g	£56.50
ST12324	24 mm	36	44.5	209 g	£57.00
ST12325	25 mm	36	44.5	23 g	£59.60







PRY BAR ROLL HEEL TYPE

	 (mm)	 (AF)		
PB12	300	12	250 g	£24.10
PB16	400	16	520 g	£32.40
PB20	500	20	974 g	£51.70



PRY BAR

	 (mm)	 (AF)		
PB12A	300	12	270 g	£20.70
PB18A	450	18	555 g	£32.00
PB22A	550	22	625 g	£34.00

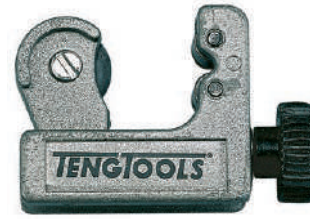

PIPE CUTTER 3 - 22MM

			
TF22	1/8 - 7/8"	110 g	£17.80





PIPE CUTTER 3 - 32MM

			
TF30	1/8 - 1-1/4"	268 g	£32.00



REPLACEMENT BLADES ROTATING PIPE CUTTER TF22/TF30 2 PIECES

		
TF2230RK	4 g	£8.30



SERVICE TOOLS



PIPE CUTTER 42MM CAPACITY PE TUBING



TFP01

618 g

£94.30



PIPE CUTTER CHAIN TYPE



TF300

771 g

£132.50



REPLACEMENT BLADES PIPE CUTTER TFP01



TFP01RK

41 g

£29.20



REPLACEMENT PIPE CUTTER CHAIN TF300



TF300RK

222 g

£88.90



ROTATING PIPE CUTTER 10MM



TFA10	10 mm	126 g	£32.90
TFA12	12 mm	145 g	£33.80
TFA15	15 mm	177 g	£36.00
TFA22	22 mm	221 g	£41.00
TFA0252RK	Replacement Blades Rotating Pipe Cutter TFA10 - TFA22 5 Pieces		£29.90



DEBURRING TOOL POCKET CLIP

- » Suitable for deburring operations on pipes, holes, edges, etc
- » HSS blade knives are swivel mounted to automatically adapt to the shape of the piece
- » Handy pocket clip for added convenience



DET02			£12.50
-------	--	--	--------



DEBURRING TOOL

- » Suitable for deburring operations on pipes, holes, edges, etc
- » HSS blade knives are swivel mounted to automatically adapt to the shape of the piece
- » Supplied with 2 HSS knife blades



DET01		£20.30
DET01RK	Replacement Blades Deburring Tool DET01	£14.50



CHAIN PIPE WRENCH



9124	912 g	£63.10
------	-------	--------



SERVICE TOOLS



CIRCUIT TESTER



9850

40 g

£12.90



CRIMPING PLIER 9" RED HANDLE



CP50

M2.5 - M5

225 g

£32.90



VOLTAGE TESTER



MDV9855

105 - 250 V

70 mm

145

33 g

£9.40



RATCHETING CRIMPING PLIER WITH THREE HEADS



CP52

537 g

£104.90



CRIMPING AND WIRE STRIPPING PLIER



CP53

20 - 8 AWG

138 g

£33.90



RATCHETING CRIMPING PLIER



CP58

570 g

£81.10



WIRE STRIPPING PLIER GUN TYPE



CP55

24 - 10 AWG

125 g

£43.00



RATCHETING WIRE STRIPPING PLIER



CP60

24 - 8 AWG

354 g

£53.20



SERVICE TOOLS



WIRE STRIPPING PLIER TPR GRIP



MB499-7T

138 g

£30.90



CABLE TIE GUN



CTG01

324 g

£56.70



WIRE TWISTING PLIER



AT605

253 g

£61.20



DIGITAL MULTIMETER



AC/DC



DM550

250V/250V

200Ω - 2-20-
200KΩ - 20MΩ

-40° - +1000°

284 g

£53.00



HAND RIVET GUN 2.4/3.2/4.0/4.8MM

	(mm)	(mm)	(mm)	(mm)		
HR12	2.4, 3.2, 4.0, 4.8	2.4, 3.2, 4.0	2.4, 3.2, 4.0, 4.8	250	465 g	£74.10



HAND RIVET GUN 2.4/3.2/4.0/4.8 MM

	(mm)	(mm)	(mm)	(mm)		
HR30R	2.4, 3.0, 3.2, 4.0, 4.8	2.4, 3.0, 3.2, 4.0	2.4, 3.0, 3.2, 4.0, 4.8	270	530 g	£88.20

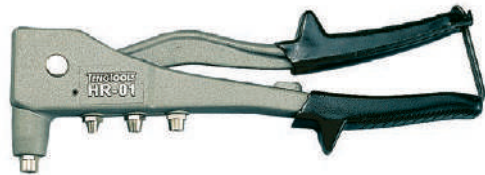

HAND RIVET GUN ALUMINIUM ALLOY 2.4/3.2/4.0/4.8MM

	(mm)	(mm)	(mm)	(mm)		
HR01	2.4, 3.2, 4.0, 4.8	2.4, 3.2, 4.0	2.4, 3.2, 4.0, 4.8	250	552 g	£87.70



HAND RIVET GUN WITH SWIVEL HEAD

	(mm)	(mm)	(mm)	(mm)		
HR360R	2.4, 3.0, 3.2, 4.0, 4.8, 5.0	2.4, 30.3.2	2.4, 3.0, 3.2, 4.0	295	710 g	£124.50



SERVICE TOOLS



LAZY TONGUE RIVET GUN

	(mm)	(mm)	(mm)		
HRLT01	3.2, 4.0, 4.8, 6.0, 6.4	3.2, 4.0, 4.8, 6.0, 6.4	3.2, 4.0, 4.8, 6.0, 6.4	2017 g	£311.00

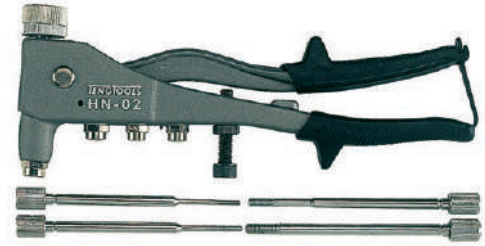

NUTSERT GUN M3/M4/M5/M6

	(mm)	(mm)		
HN02	M3, M4, M5, M6	250	755 g	£174.40



LONG HANDLED RIVET GUN

	(mm)	(mm)	(mm)		
HRLR01	3.2, 4.0, 4.8, 6.0, 6.4	3.2, 4.0, 4.8, 6.0, 6.4	3.2, 4.0, 4.8, 6.0, 6.4	1765 g	£274.00



LONG HANDLED NUTSERT GUN

	(mm)	(mm)		
HRLN65N	M5, M6, M8, M10	530	2225 g	£795.00



SCRIBER

		(mm)		
SCR01	Replaceable tip	135	16 g	£20.10



SCRIBER WITH CARBIDE TIP

		(mm)		
SCR02	Tungsten Carbide (K20)	150	34 g	£6.50



CLAW PICK UP TOOL

AT135	600	72 g	£23.80



TELESCOPIC MAGNIFYING GLASS

581TMG	960	79 g	£28.50



MAGNETIC CLAW PICK UP TOOL

AT135M	600	95 g	£37.10



TELESCOPIC INSPECTION MIRROR

581TMI	960	78 g	£28.00



MAGNETIC BRACELET

583M	340	134 g	£20.30



TELESCOPIC MAGNETIC PICK UP TOOL

581TMP	4500g	760	68 g	£29.90



SERVICE TOOLS



TELESCOPIC PICK UP TOOL 550MM



SD501

200g

160-550

27 g

£12.40



LED TORCH WITH POCKET CLIP



585

32 g

£38.70



TELESCOPIC INSPECTION TOOL 3 IN 1



582MI

570

50 g

£30.90



RECHARGEABLE LED FLASHLIGHT 1200 LM



584N

1200 lm

USB-C

IPX6

180

263 g

£76.40



TELESCOPIC MAGNETIC PICK UP TOOL AND PEN



585MP

630

33 g

£21.70



TORCH POCKET CLIP



581N1

53 g

£48.10



RECHARGEABLE LED HEADLAMP 350 LM



586D 350 lm USB-C IPX4 79 g £21.30



RECHARGEABLE MULTI-PURPOSE LED HEADLAMP 400 LM

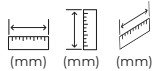

586N 400 lm USB-C IPX6 84 42 38 85 g £51.90



RECHARGEABLE LED WORKLIGHT 1000 LM

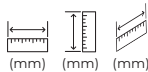

588N 1000 lm USB-C IP67 148 56 26 243 g £66.20



MAGNETIC LED LIGHT BAR

- 255mm wide light bar with 9 built in white LED lights
- 120 light distribution angle to illuminate a wide area
- Magnetic attachment for fixing quickly and simply with no drilling required
- Requires 3 AA batteries (not included)
- Ideal for use with workbenches as a light source



587J 190 g £93.00



FLEXIBLE LIGHT WITH MAGNET

- Flexible and adjustable to illuminate work areas
- Magnet on the end makes it ideal for seeing and then retrieving items from confined spaces
- Requires 2 AA batteries (not included)



586 104 g £74.00



SERVICE TOOLS



MAGNETIC BITS TRAY ROUND



580

150 mm

343 g

£24.00



PLASTIC MAGNETIC BOWL 112MM



580Q

112 mm

179 g

£18.00



MAGNETIC BITS TRAY SQUARE



580S

1404 g

£68.80



WELDING MAGNET 75MM



MH75

75 x 14 mm

30 kg

332 g

£14.50

MH90

90 x 17 mm

30 kg

756 g

£23.40



MAGNETIC BITS TRAY RECTANGULAR DEEP



580A

819 g

£52.90



QUICK CLAMP TOP LEVER



CMQ150	1580 N	150 mm	360 mm	85 mm	601 g	£39.60
CMQ300	1580 N	300 mm	510 mm	85 mm	694 g	£44.70
CMQ450	1580 N	450 mm	660 mm	85 mm	807 g	£50.90
CMQ600	1580 N	600 mm	810 mm	85 mm	907 g	£57.80



SCREW CLAMP



CMD16	2648 N	160 mm	80 mm	719 g	£31.80
CMD20	3922 N	200 mm	100 mm	1117 g	£46.90
CMD30A	5393 N	300 mm	140 mm	2062 g	£68.30
CMD40	5393 N	400 mm	140 mm	2276 g	£67.90
CMD40A	5393 N	400 mm	175 mm	2692 g	£76.90
CMD80	4903 N	800 mm	120 mm	2472 g	£74.20



QUICK CLAMP BOTTOM LEVER



CMQL150	1780 N	150 mm	80 mm	666 g	£47.90
CMQL300	1780 N	300 mm	80 mm	784 g	£54.20
CMQL450	1780 N	450 mm	80 mm	897 g	£62.50



F-TYPE CLAMP SWIVEL HANDLE



CMF16T	16,5 x 7,5 mm	160 mm	80 mm	580 g	£56.30
CMF20T	19,5 x 9,5 mm	200 mm	100 mm	1009 g	£67.60
CMF25T	22,0 x 10,5 mm	250 mm	120 mm	1341 g	£81.40
CMF30T	25,0 x 12,0 mm	300 mm	140 mm	1957 g	£98.70
CMF35T	25,0 x 12,0 mm	300 mm	100 mm	1146 g	£94.90





F-TYPE CLAMP FIXED HANDLE



CMF16	16,5 x 7,5 mm	160 mm	80 mm	478 g	£43.00
CMF20	19,5 x 9,5 mm	200 mm	100 mm	895 g	£60.70
CMF25	22,0 x 10,5 mm	250 mm	120 mm	1225 g	£68.90
CMF30	25,0 x 12,0 mm	300 mm	140 mm	1823 g	£84.40
CMF35	25,0 x 12,0 mm	300 mm	100 mm	1754 g	£84.30



RATCHET CLAMP



CMFQ25	22,0 x 10,5 mm	250 mm	120 mm	1493 g	£138.90
CMFQ40	25,0 x 12,0 mm	400 mm	120 mm	2439 g	£177.90



4" WORK BENCH VICE



TCAV4	8720 g	£325.90
-------	--------	---------



HINGE ADJUSTMENT WRENCH

DHW1300	13 mm	220	171 g	£17.60	
DHW1417	14 x 17 mm	290	335 g	£26.00	
DHW1922	19 x 22 mm	300	364 g	£29.00	



ENGINEERS HAMMER

HMEG300	Fibre glass	300	478 g	£22.80	
HMEG500	Fibre glass	320	718 g	£27.60	
HMEG800	Fibre glass	350	1083 g	£35.40	



BALL PEIN HAMMER

HMBP12	12 oz	Fibre glass	28 mm	280	483 g	£23.70
HMBP16	16 oz	Fibre glass	30 mm	320	689 g	£28.40
HMBP24	24 oz	Fibre glass	35 mm	380	1002 g	£39.40
HMBP32	32 oz	Fibre glass	39 mm	380	1198 g	£42.10



LUMP HAMMER

HMS1250	Round	296	1564 g	£61.00	



CARPENTERS CLAW HAMMER

HMCH13A	13 oz	Round	27 mm	335	557 g	£32.80
HMCH16A	16 oz	Round	27 mm	312	689 g	£33.50



SERVICE TOOLS



CARPENTERS SHOCK ABSORBENT CLAW HAMMER



HMCHM16 16 oz Forged steel 29 mm 333 720 g £69.90



SOFT FACE HAMMER



HMSF Round 320 652 g £41.80



CARPENTERS MAGNETIC CLAW HAMMER



HMCH16M 16 oz Round 27.5 mm 341 690 g £42.20



DEADBLOW HAMMER PU



HMDH50PU 50 mm 711 g £71.30

HMDH60PU 60 mm 1168 g £76.40

HMDH70PU 70 mm 1600 g £97.80



DEAD BLOW HAMMER



HMDH35 35 mm 345 g £31.80

HMDH45 45 mm 500 g £46.00

HMDH55 55 mm 1010 g £51.30

HMDH65 65 mm 1505 g £69.80



PARALLEL PIN PUNCH

PP03	3 mm	150	63 g	£8.90	
PP04	4 mm	150	65 g	£8.90	
PP05	5 mm	150	68 g	£8.90	
PP06	6 mm	150	71 g	£8.90	
PP07	7 mm	150	110 g	£11.20	
PP08	8 mm	150	117 g	£11.20	



CENTRE PUNCH

CP04	4 mm	150	70 g	£9.60	
CP05	5 mm	150	72 g	£9.60	
CP08	8 mm	150	117 g	£10.80	



AUTOMATIC CENTRE PUNCH

SCP01	1 mm		47 g	£27.80



FLAT COLD CHISEL

CC150F	18 mm	150	178 g	£14.80	
CC200F	25 mm	200	401 g	£23.00	
CC240F	26 mm	240	265 g	£27.10	
CC250F	25 mm	250	505 g	£27.90	



SERVICE TOOLS



6

PCS

PARALLEL PIN PUNCH SET 6 PIECES



» 3, 4, 5, 6, 7, 8



PPS06

£45.70



5

PCS

PUNCH & CHISEL SET 5 PIECES



» Flat Cold Chisel 150 × 18 mm
 » Centre Punch 5 mm
 » Parallel Pin Punch
 » 3, 4, 5



PCX05

£46.10



ELASTIC STRAP



SSH02



1,35 m



3 kg



85 g

£30.70



MAGNETIC RACK FOR TYRE TOOLS

- Magnetic shelf for storing tyre tools
- Designed to take 4 sockets, torque wrench and an air wrench
- Can be easily fitted to any flat ferrous material surface
- Powerful magnets for secure fixing
- Ideal for using on the side of a tool cabinet



BDIS-TYR



1117 g

£87.90



KNEELING PAD

KP01	450	210	30.5	140 g	£29.30



MECHANICS WORK CHAIR

TCA06	420 - 500 mm	5445 g	£179.90



KNEELING PAD

KP02	880	300	30.5	410 g	£74.10



MECHANICS CREEPER

TCA07	1050	500	155	8500 g	£212.90



SERVICE TOOLS



SAFETY GLASSES



SG960

Clear

SCRATCH
RESISTANT
Yes

ANTI
FOG
Yes



22 g

£9.00



SAFETY GLASSES



SG960A

Clear

SCRATCH
RESISTANT
Yes

ANTI
FOG



22 g

£8.10



SAFETY GLASSES



SG960G

Grey/Smoke

SCRATCH
RESISTANT
Yes

ANTI
FOG
Yes



24 g

£9.00



SAFETY GLASSES SPORT STYLE



SG713



26 g

£13.10



SAFETY GLASSES



SG960Y

Amber

SCRATCH
RESISTANT
Yes

ANTI
FOG
Yes



23 g

£9.00



SAFETY GLASSES SPORT STYLE



SG713G



26 g

£17.40



SUN GLASSES RED FRAMES



P-SG01

Grey/Smoke



35 g

£28.00



SUN GLASSES MIRROR LENS



P-SG03

Mirror effect



31 g

£30.90



SUN GLASSES BLACK FRAMES



P-SG02

Grey/Smoke



34 g

£28.00



AIR TOOLS

ESSENTIAL FOR ANY WORKSHOP

Air is a powerful and versatile resource that can help you get the job done quickly! If you need to cut through steel or machine-tighten a bolt, you will need a certain amount of torque. Choosing a tool for its convenience or cost really won't do any good if it isn't strong enough to get the job done. This range of air tools pack a real punch and have been developed to exceed the demands of a professional auto workshop.





AIR TOOLS



AIR IMPACT WRENCH

3/8"



ARWM38

1562 g

£362.00



Bolt capacity	M13
Free speed	9000 rpm
Max torque (3 steps)	115/285/465 Nm
Max reverse torque	361 ft-lb
Hammer mechanism	Twin hammer
Sound level *	95.4 dB
Vibration **	4.96 m/s ²
Minimum hose size	3/8"
Air inlet	1/4" PT-19"
Air consumption at 100% int.	3.7 cfm
Length	159.4



COMPOSITE AIR IMPACT WRENCH

3/8"



ARWC38

1352 g

£357.00



Bolt capacity	M13
Free speed	9000 rpm
Max torque (3 steps)	163/244/450 Nm
Max reverse torque	346 ft-lb
Hammer mechanism	Twin hammer
Sound level *	94 dB
Vibration **	3.8 m/s ²
Minimum hose size	3/8"
Air inlet	1/4" PT-19"
Air consumption at 100% int.	4.5 cfm
Length	161

**COMPOSITE AIR IMPACT WRENCH****1/2"**

ARWC12

2082 g

£409.00



Bolt capacity	M16
Free speed	6800 rpm
Max torque (3 steps)	258/461/930 Nm
Max reverse torque	708 ft-lb
Hammer mechanism	Twin hammer
Sound level *	96 dB
Vibration **	3.6 m/s ²
Minimum hose size	3/8"
Air inlet	1/4" PT-19"
Air consumption at 100% int.	5.1 cfm
Length	186

**STRAIGHT AIR IMPACT WRENCH****1"**

ARWM11S

8183 g

£1,688.00



Bolt capacity	M36
Free speed	5500 rpm
Max torque (4 steps)	976/1300/1735/2712 Nm
Max reverse torque	2013 ft-lb
Hammer mechanism	Twin hammer
Sound level *	104.5 dB
Vibration **	12.88 m/s ²
Minimum hose size	3/4"
Air inlet	1/2" PT-14"
Air consumption at 100% int.	9.6 cfm
Length	504.5



AIR TOOLS



AIR DRILL



ARD10

1241 g

£198.00



Chuck Size	10 mm
Free speed	1800 rpm
Sound level *	88 dB
Vibration **	3 m/s ²
Minimum hose size	3/8"
Air inlet	1/4" PT-19"
Air consumption at 100% int.	4 cfm



AIR DRILL



ARD13

2075 g

£293.00



Chuck Size	13 mm
Free speed	450 rpm
Sound level *	89 dB
Vibration **	2 m/s ²
Minimum hose size	3/8"
Air inlet	1/4" PT-19"
Air consumption at 100% int.	5 cfm



AIR SAW



ARS01 815 g £399.00

Stroke Length	10 mm
Stroke per minute	9000 bpm
Sound level *	84 dB
Vibration **	2.4 m/s ²
Minimum hose size	3/8"
Air inlet	1/4" PT-19"
Air consumption at 100% int.	1.08 cfm
Length	245.1
Cutting Capacity - Aluminium	3 mm
Cutting Capacity - Steel	3 mm
Cutting Capacity - Wood	4 mm

AIR SAW



ARS02 399 g £325.00

Stroke Length	10 mm
Stroke per minute	9000 bpm
Sound level *	84.4 dB
Vibration **	5.26 m/s ²
Minimum hose size	3/8"
Air inlet	1/4" PT-19"
Air consumption at 100% int.	0.81 cfm
Length	170
Cutting Capacity - Aluminium	3.4 mm
Cutting Capacity - Steel	3 mm
Cutting Capacity - Wood	4 mm





STRAIGHT AIR DIE GRINDER



ARG01 606 g £149.00



Collet	6 mm
Free speed	25000 rpm
Sound level *	82 dB
Vibration **	5 m/s ²
Minimum hose size	3/8"
Air inlet	1/4" PT-19"
Air consumption at 100% int.	4 cfm
Length	161



AIR BELT SANDER



ARBS10 1073 g £435.90



For sanding belt	6 x 330, 10 x 330 mm
Free speed	20000 rpm
Sound level *	96.5 dB
Vibration **	0.66 m/s ²
Minimum hose size	3/8"
Air inlet	1/4" PT-19"
Air consumption at 100% int.	4.2 cfm

AIR TOOLS



AIR ENGRAVING PEN



AREP25 237 g £166.90



Working Pressure	6.2 bar
Stroke per minute	13000 bpm
Sound level *	90 dB
Vibration **	2.5 m/s ²
Air inlet	1/4" PT-19"
Air consumption at 100% int.	1.1 cfm



AIR BLOW GUN



ARB01 101 g £13.60



Nozzle Length	100 mm
Air inlet	1/4"
Length	212



AIR BLOW GUN



ARB02 128 g £14.60



Nozzle Length	270 mm
Air inlet	1/4"
Length	360

AIR BLOW GUN



ARB03 109 g £13.90



Nozzle Length	100 mm
Air inlet	1/4"
Length	212





















INDEX

	1" Deep Impact Socket DIN Metric	295	1/2" Hex Impact Socket DIN Metric	290
	1" Deep Thinwall Impact Socket DIN Metric	295	1/2" Impact Driver Set TTI 20 Pieces	74
	1" Extension Bar	258	1/2" Impact Extension Bar	283
	1" Extra Long Impact Socket Metric	296	1/2" Impact Socket Accessories Set ANSI TTI 11 Pieces	71
	1" Impact Socket DIN Metric	295	1/2" Impact Socket Accessories Set DIN TTI 11 Pieces	71
	1" Impact Socket Set DIN 27 - 50mm 13 Pieces	249	1/2" Impact Socket ANSI Metric	287
	1" Impact Socket Set DIN 36 - 80mm 17 Pieces	249	1/2" Impact Socket Clip Rail Set ANSI 10 Pieces	248
	1" Power Bar	255	1/2" Impact Socket DIN AF	287
	1" Ratchet	255	1/2" Impact Socket DIN Metric	286
	1" Ratchet Head	255	1/2" Impact Socket Set AF DIN FOAM1 16 Pieces	148
	1" Socket 12 pt Metric	282	1/2" Impact Socket Set ANSI FOAM2 21 Pieces	148
	1" Socket Set 12 pt 15 Pieces	239	1/2" Impact Socket Set ANSI TTI 16 Pieces	72
	1" Torque Wrench Plus 1000 Nm	305	1/2" Impact Socket Set DIN TTI 12 Pieces	72
	1" Torque Wrench Plus 1500/2000 Nm	305	1/2" Impact Socket Set DIN TTI 20 Pieces	72
	1/2" & 5/16" Impact Driver Set 15 Pieces	372	1/2" Impact Socket Set FOAM4X4 103 Pieces	149
	1/2" & 5/16" Impact Driver Set 6 Pieces	372	1/2" Impact Socket Wheel Nut	467
	1/2" Bit Adaptor	260	1/2" Impact Socket Wheel Nut Set	466-467
	1/2" Deep Impact Socket ANSI Metric	289	1/2" Long Hex & TX Bit Socket Set FOAM2 17 Pieces	141
	1/2" Deep Impact Socket Clip Rail Set ANSI 10 Pieces	248	1/2" Long Hex & TX Bit Socket Set TTI 15 Pieces	67
	1/2" Deep Impact Socket DIN AF	289	1/2" Long Hex Bit Socket Clip Rail Set 6 Pieces	238
	1/2" Deep Impact Socket DIN Metric	288	1/2" Long Hex Bit Socket Metric	277
	1/2" Deep Impact Socket Set AF DIN FOAM1 14 Pieces	148	1/2" Long Ratchet Flexible Head	254
	1/2" Deep Socket 12 pt Metric	276	1/2" Long Ribe® & XZN/Triple Square Bit Socket Set TTI 15 Pieces	68
	1/2" Deep Socket 6 pt Metric	275	1/2" Long Ribe® Bit Socket	280
	1/2" Deep Socket Clip Rail Set 12 pt 8 Pieces	237	1/2" Long TX Bit Socket	278
	1/2" Deep Socket Clip Rail Set 6 pt 8 Pieces	237	1/2" Long XZN/Triple Square Bit Socket	280
	1/2" Double Ended Impact Socket Metric	290	1/2" Oil Filter Removal Tool Chain Type	464
	1/2" Double Ended Impact Socket Set	467	1/2" Oil Filter Removal Tool Strap Type	464
	1/2" Extendable Ratchet	254	1/2" Ratchet & Accessories Set TTI 5 Pieces	65
	1/2" Extension Bar	258	1/2" Ratchet FRP 45 Teeth	253
	1/2" Extra Long Hex Bit Socket Metric	277	1/2" Ratchet Long Arm	254
	1/2" Extra Long TX Cylinder Head Bit Socket	278	1/2" Socket & Tool Set HDV 105 Pieces	176
	1/2" Flex Head Adaptor	259	1/2" Socket & Tool Set HDV E 105 Pieces	176
	1/2" Heavy Duty Oil Filter Removal Tool	465	1/2" Socket 12 pt AF	275
	1/2" Hex Bit Socket AF	277	1/2" Socket 12 pt Metric	274
	1/2" Hex Bit Socket Clip Rail Set 9 Pieces	238	1/2" Socket 6 pt Metric	274
	1/2" Hex Bit Socket Clip Rail Set AF 9 Pieces	238	1/2" Socket Clip Rail Set 12 pt 15 Pieces	237
	1/2" Hex Bit Socket Metric	276	1/2" Socket Clip Rail Set 12 pt AF 15 Pieces	237
	1/2" Hex Bit Socket Set TTI 16 Pieces	66	1/2" Socket Set 12 pt 12 Pieces	234
	1/2" Hex Bit Socket Set TTI 23 Pieces	67	1/2" Socket Set 12 pt AF TTI 15 Pieces	66
	1/2" Hex Impact Socket DIN AF	290	1/2" Socket Set 12 pt FOAM2 27 Pieces	141



















1/2" Socket Set 12 pt FOAM4X4 63 Pieces	143	1/4" & 3/8" TX-E Socket Clip Rail Set 10 Pieces	233
1/2" Socket Set 12 pt TTI 11 Pieces	65	1/4" Bit Adaptor	260
1/2" Socket Set 12 pt TTI 17 Pieces	65	1/4" Bits Driver Extension	366
1/2" Socket Set 12 pt TTI 17 Pieces	65	1/4" Deep Socket 12 pt AF	264
1/2" Socket Set 6 pt TTI 17 Pieces	65	1/4" Deep Socket 12 pt Metric	263
1/2" Socket Set 6 pt TTI 18 Pieces	66	1/4" Deep Socket 6 pt AF	264
1/2" Spark Plug Socket	463	1/4" Deep Socket 6 pt Metric	263
1/2" Stubby Impact Socket Clip Rail Set DIN 12 Pieces	248	1/4" Deep Socket Clip Rail Set 6 pt 9 Pieces	226
1/2" Stubby Impact Socket DIN Metric	288	1/4" Die Chuck	440
1/2" Stud Extractor	476	1/4" Double Ended Flat Bits	350
1/2" Stud Extractor Eccentric	476	1/4" Double Ended PH Bits	351
1/2" Stud Extractor Socket	476	1/4" Double Ended PZ Bits	354
1/2" Torque Stick	307	1/4" Double Ended TX Bits	357
1/2" Torque Sticks & Wheel Nut Set TTI 8 Pieces	73	1/4" Extension Bar	258
1/2" Torque Wrench	301	1/4" Extension Bar For MDR913	367
1/2" Torque Wrench & Breaker Bar Set TTX4	76	1/4" Flat Bit Socket	264
1/2" Torque Wrench Bi-directional	302	1/4" Flat Bits 70mm	350
1/2" Torque Wrench Plus	302	1/4" Flat Bits 89mm	351
1/2" Torque Wrench P-Series 40-200 Nm TTX4	76	1/4" Flexible Bit Holder	367
1/2" TPX Bit Socket	279	1/4" Gearless Palm Ratchet	252
1/2" TPX Bit Socket Clip Rail Set 9 Pieces	239	1/4" Hex Bit Socket Clip Rail Set 9 Pieces	227
1/2" TX Bit Socket	278	1/4" Hex Bit Socket Metric	265
1/2" TX Bit Socket Clip Rail Set 9 Pieces	239	1/4" Hex Bits 25mm	361
1/2" TX Bit Socket Set TTI 18 Pieces	67	1/4" Hex Bits 50mm	361
1/2" TX Bit Socket Set TTI 23 Pieces	67	1/4" Hex Bits 89mm	362
1/2" TX Impact Socket DIN	291	1/4" Hex drive impact socket adaptor	367
1/2" TX Impact Socket Set DIN TTI 12 Pieces	72	1/4" Hex Impact Bits 30mm	362
1/2" TX-E Socket	279	1/4" Hex Impact Bits 50mm	362
1/2" TX-E Socket Clip Rail Set 9 Pieces	238	1/4" Hex Twist extractor Cr-Mo	474
1/2" Wheel Wrench	467	1/4" Impact Bit Adaptor	367
1/2" Wobble Extension Bar	258	1/4" Impact Driver Set	372
1/2" XZN/Triple Square Impact Socket	291	1/4" Impact Driver Set TTI 19 Pieces	74
1/2" XZN/Triple Square Impact Socket Set DIN 6 Pieces	245	1/4" Impact Nut Setter	365
1/4" & 1/2" Socket Set 6 pt FOAM4X4 126 Pieces	145	1/4" Impact Socket ANSI Metric	284
1/4" & 1/2" Socket Set FOAM3 44 Pieces	141	1/4" Long Flexible Bits Driver	373
1/4" & 3/8" Bit Socket Set FOAM2 47 Pieces	140	1/4" Long Ratchet Flexible Head	254
1/4" & 3/8" Bit Socket Set TTI 35 Pieces	64	1/4" Magnetic Bit Holder	365
1/4" & 3/8" Impact Socket Set ANSI TTI 24 Pieces	70	1/4" Magnetic Bits 25mm	364
1/4" & 3/8" Socket Set 12 pt AF TTI 32 Pieces	62	1/4" Magnetic Bits Driver 193mm	373
1/4" & 3/8" Socket Set AF 6 pt TTI 32 Pieces	61	1/4" Magnetic Bits Driver 217mm	373
1/4" & 3/8" Socket Set FOAM4X4 86 Pieces	145	1/4" Magnetic Impact Bit Holder	366

INDEX

	1/4" Mini Bits Ratchet	372	1/4" Socket 12 pt AF	262
	1/4" Mini Palm Ratchet	252	1/4" Socket 12 pt Metric	261
	1/4" Mini Ratchet 72 Teeth	252	1/4" Socket 6 pt AF	262
	1/4" Nut Setter	365	1/4" Socket 6 pt Metric	261
	1/4" PH Bit Socket	264	1/4" Socket Clip Rail Set 6 pt 12 Pieces	226
	1/4" PH Bits 50mm	352	1/4" Socket Set 12 pt TTI 35 Pieces	61
	1/4" PH Bits 70mm	352	1/4" Socket Set 6 pt 13 Pieces	222
	1/4" PH Bits 89mm	352	1/4" Socket Set 6 pt 22 Pieces	223
	1/4" PH G Bits 25mm	354	1/4" Socket Set 6 pt 23 Pieces	224
	1/4" PH G Impact Bits 30mm	354	1/4" Socket Set 6 pt 24 Pieces	224
	1/4" PH G Impact Bits 50mm	354	1/4" Socket Set 6 pt 36 Pieces	225
	1/4" PH Impact Bits 30mm	353	1/4" Socket Set 6 pt 8 Pieces	223
	1/4" PH Impact Bits 50mm	353	1/4" Socket Set 6 pt AF 35 Pieces	225
	1/4" PH Impact Bits 89mm	353	1/4" Socket Set 6 pt FOAM2 89 Pieces	139
	1/4" PZ Bit Socket	265	1/4" Socket Set 6 pt TTI 35 Pieces	60
	1/4" PZ Bits 50mm	355	1/4" Socket Set 6 pt With Belt Clip 19 Pieces	54,222
	1/4" PZ Bits 70mm	355	1/4" Socket Set 6 pt With Belt Clip 20 Pieces	54,223
	1/4" PZ Bits 89mm	356	1/4" Socket With Magnetic Tip	259
	1/4" PZ Impact Bits 30mm	356	1/4" Stubby Bits Driver	373
	1/4" PZ Impact Bits 50mm	356	1/4" Stubby Ratcheting Bits Driver Set	375
	1/4" PZ Impact Bits 89mm	356	1/4" T Handle Quick Chuck Bits Driver	374
	1/4" Quick Chuck Bit Holder 35mm	366	1/4" Tap Chuck	440
	1/4" Quick Chuck Bit Holder 50mm	365	1/4" Torque Screwdriver	300
	1/4" Quick Chuck Bits Driver 147mm	374	1/4" Torque Set FOAMX2 2 Pieces	151
	1/4" Quick Chuck Bits Driver 183mm	374	1/4" Torque Wrench	300
	1/4" Quick Chuck Bits Driver 217mm	374	1/4" Torque Wrench Plus	300
	1/4" Quick Chuck Impact Bit Holder	366	1/4" TPX Bits 25mm	361
	1/4" Ratchet FRP 45 Teeth	253	1/4" TX Bit Socket	265
	1/4" Ratchet Head Hex	252	1/4" TX Bit Socket Clip Rail Set 8 Pieces	227
	1/4" Ratchet Long Arm	254	1/4" TX Bits 25mm	357
	1/4" Ratcheting Angled Bits Driver Set	375	1/4" TX Bits 50mm	358
	1/4" Ratcheting Bits Driver Double End Bits Set	375	1/4" TX Bits 70mm	358
	1/4" Ratcheting Bits Driver Set	375	1/4" TX Bits 89mm	358
	1/4" Ratcheting Quick Chuck Bits Driver	376	1/4" TX Impact Bits 30mm	359
	1/4" ROB Bits 25mm	363	1/4" TX Impact Bits 50mm	359
	1/4" ROB Impact Bits 30mm	364	1/4" TX Impact Bits 89mm	359
	1/4" ROB Impact Bits 50mm	364	1/4" TX-E Socket	265
	1/4" ROB Impact Bits 89mm	364	1/4", 3/8" & 1/2" drive metric socket set FOAM4X4 67 pieces	146
	1/4" Screw Extractor	474	1/4", 3/8" & 1/2" Socket Set FOAM4X4 73 Pieces	147
	1/4" Socket & Bits Set FOAM1 87 Pieces	139	1/4", 3/8" & 1/2" Socket Set FOAM4X4 76 Pieces	146
	1/4" Socket & Bits Set TTI 48 Pieces	62	1/4", 3/8" & 1/2" Socket Set FOAM4X4 85 Pieces	147































11" PRO35™ tool chest 2 drawers red	187	3/4" Deep Impact Socket DIN AF	294
1-1/2" Impact Socket DIN Metric	296	3/4" Deep Impact Socket DIN Metric	293
15" PRO35™ side cabinet 1 drawer red	202	3/4" Extendable Ratchet	254
15" PRO35™ side cabinet 7 drawers red	202	3/4" Extension Bar	258
15" PRO35™ Side Cabinet With Door Red	203	3/4" Extra Long Impact Socket Metric	294
18 mm laminated work top	215	3/4" Hex Bit Socket Metric	282
20" Straight/Bent Ratcheting Circlip Plier	411	3/4" Hex Impact Socket DIN Metric	294
26" Classic Full Depth Tool Chest 5 Drawers Red	200	3/4" Impact Extension Bar	283
26" Classic Roller Cabinet 7 Drawers Red	201	3/4" Impact Socket DIN AF	292
26" Classic Roller Cabinet FOAM Tool Kit 179 Pieces Red	120	3/4" Impact Socket DIN AF	292
26" Classic Tool Chest 3 Drawers Red	201	3/4" Impact Socket DIN Metric	292
26" Classic Tool Chest 4 Drawer Red	200	3/4" Impact Socket Set DIN FOAM4X4 33 Pieces	150
26" PRO Roller Cabinet 7 Soft Close Drawers Red	202	3/4" Impact Socket Set DIN TTX4 15 Pieces	73
26" PRO35™ deep tool chest 5 drawers red	189	3/4" Ratchet & Accessories Set FOAMX4 3 Pieces	143
26" PRO35™ low roller cabinet 4 drawers red	192	3/4" Ratchet & Accessories Set TTX4 2 Pieces	69
26" PRO35™ low roller cabinet 6 drawers red	192	3/4" Ratchet & Accessories Set TTX4 4 Pieces	69
26" PRO35™ Mega Master tool kit 1033 pieces black	29	3/4" Socket & Spanner Set FOAM4X4 25 Pieces	144
26" PRO35™ Mega Master tool kit 1033 pieces red	27	3/4" Socket 12 pt AF	281
26" PRO35™ roller cabinet 6 drawers red	193	3/4" Socket 6 pt Metric	281
26" PRO35™ roller cabinet 7 drawers red	193	3/4" Socket Set 12 pt AF TTX4 14 Pieces	69
26" PRO35™ roller cabinet 9 drawers black	194	3/4" Socket Set 6 pt FOAMX4 10 Pieces	143
26" PRO35™ roller cabinet 9 drawers red	194	3/4" Socket Set 6 pt TTX4 14 Pieces	69
26" PRO35™ roller cabinet FOAM tool kit 278 pieces red	119	3/4" Socket Set FOAM4X4 32 Pieces	144
26" PRO35™ roller cabinet FOAM tool kit 335 pieces red	118	3/4" Torque Wrench	303
26" PRO35™ roller cabinet tool kit 516 pieces red	42	3/4" Torque Wrench Bi-directional	304
26" PRO35™ roller cabinet tool kit 628 pieces red	43	3/4" Torque Wrench Plus	304
26" PRO35™ stack FOAM tool kit 418 pieces red	109	3/8" & 1/2" Hex Impact Socket Set DIN TT1 15 Pieces	73
26" PRO35™ stack FOAM tool kit 528 pieces red	111	3/8" & 1/2" Impact Socket Set FOAM4X4 73 Pieces	149
26" PRO35™ stack FOAM tool kit 702 pieces red	113	3/8" & 1/2" Torque Wrench Set FOAMX4 2 Pieces	152
26" PRO35™ stack tool kit 1034 pieces red	31	3/8" Bit Adaptor	260
26" PRO35™ stack tool kit 753 pieces red	33	3/8" Crow Foot Wrench	307
26" PRO35™ stack tool storage 16 drawers black	198	3/8" Crow Foot Wrench Clip Rail Set 8 Pieces	233
26" PRO35™ stack tool storage 16 drawers red	198	3/8" Deep Impact Socket ANSI Metric	285
26" PRO35™ tool chest 3 drawers black	190	3/8" Deep Impact Socket Clip Rail Set ANSI 8 Pieces	247
26" PRO35™ tool chest 3 drawers red	190	3/8" Deep Socket 12 pt AF	269
26" PRO35™ tool chest 4 drawers black	188	3/8" Deep Socket 12 pt Metric	268
26" PRO35™ tool chest 4 drawers black without logo	189	3/8" Deep Socket 6 pt AF	269
26" PRO35™ tool chest 4 drawers red	188	3/8" Deep Socket 6 pt Metric	268
26" PRO35™ tool chest tool kit 137 pieces red	44	3/8" Deep Socket Clip Rail Set 6 pt 7 Pieces	231
27" Cabinet FOAM Tool Kit 217 Pieces Red	120	3/8" Extendable Ratchet	254
3/4 Impact Socket Set DIN TT2 16 Pieces	73	3/8" Extension Bar	258

INDEX

	3/8" Hex Bit Impact Socket DIN Metric	286	3/8" T-Bar Spark Plug Socket	463
	3/8" Hex Bit Socket AF	272	3/8" Torque Wrench	301
	3/8" Hex Bit Socket Clip Rail Set 9 Pieces	231	3/8" Torque Wrench Plus	301
	3/8" Hex Bit Socket Clip Rail Set AF 8 Pieces	232	3/8" Torque Wrench Set 20-110 Nm TTX4 22 Pieces	76
	3/8" Hex Bit Socket Metric	270	3/8" TPX Bit Socket	273
	3/8" Impact Extension Bar	283	3/8" TPX Bit Socket Clip Rail Set 9 Pieces	232
	3/8" Impact Socket ANSI Metric	285	3/8" TX Bit Socket	272
	3/8" Insulated Extension Bar	426	3/8" TX Bit Socket Clip Rail Set 9 Pieces	232
	3/8" Insulated Ratchet	426	3/8" TX Bit Socket Set TTI 30 Pieces	64
	3/8" Insulated Socket	427	3/8" TX-E Socket	273
	3/8" Insulated Socket Set FOAM2 18 Pieces	169	3/8" Wobble Extension Bar	258
	3/8" Insulated Socket Set TTI 14 Pieces	95	37" PRO35™ roller cabinet 7 drawers red	195
	3/8" Long Hex Bit Socket Ball Point Clip Rail Set 9 Pieces	232	37" PRO35™ roller cabinet 8 drawers black	195
	3/8" Long Hex Bit Socket Ball Point Metric	271	37" PRO35™ roller cabinet FOAM tool kit 513 pieces red	117
	3/8" Long Hex Bit Socket Clip Rail Set 9 Pieces	231	37" PRO35™ roller cabinet FOAM tool kit 637 pieces red	115
	3/8" Long Hex Bit Socket Metric	271	37" PRO35™ roller cabinet tool kit 1008 pieces black	37
	3/8" Long Ratchet Flexible Head	254	37" PRO35™ roller cabinet tool kit 595 pieces red	41
	3/8" Long Ribe® Bit Socket	272	37" PRO35™ roller cabinet tool kit 663 pieces red	39
	3/8" Long Ribe® Bit Socket Clip Rail Set 6 Pieces	233	37" PRO35™ stack tool storage 12 drawers red	199
	3/8" Long T Bar Socket Set TTX4 9 Pieces	99	37" PRO35™ tool chest 5 drawers red	191
	3/8" Long TX Bit Socket	273	4" Work Bench Vice	490
	3/8" Long TX Bit Socket Clip Rail Set 9 Pieces	233	5 mm EVA top foam for roller cabinet	215
	3/8" Mini Ratchet 72 Teeth IP5X	253	5/16" Bit Set With 1/2" Coupler TX 4 Pieces	368
	3/8" Ratchet FRP 45 Teeth	253	5/16" Flat Impact Driver Bits	351
	3/8" Ratchet Long Arm	254	5/16" Hex Impact Driver Bits	363
	3/8" Socket 12 pt AF	267	5/16" Impact Bit Set Mixed 13 Pieces	368
	3/8" Socket 12 pt Metric	266	5/16" Impact Bit Set Mixed 4 Pieces	368
	3/8" Socket 6 pt AF	267	5/16" PH Impact Driver Bits	353
	3/8" Socket 6 pt Metric	266	5/16" PZ Impact Driver Bits	357
	3/8" Socket Clip Rail Set 6 pt 16 Pieces	231	5/16" TX Impact Driver Bits	359
	3/8" Socket Set 12 pt TTI 16 Pieces	63	53" PRO35™ Monster stack FOAM tool kit 1133 pieces red	107
	3/8" Socket Set 12 pt TTI 19 Pieces	63	53" PRO35™ Monster stack tool kit 1295 pieces red	25
	3/8" Socket Set 6 pt 12 Pieces	227	53" PRO35™ roller cabinet 9 drawers red	196
	3/8" Socket Set 6 pt 34 Pieces	228	53" PRO35™ roller cabinet tool kit 615 pieces red	35
	3/8" Socket Set 6 pt FOAM2 36 Pieces	140	53" PRO35™ stack tool storage 19 drawers red	199
	3/8" Socket Set 6 pt TTI 16 Pieces	63	53" PRO35™ tool chest 10 drawers red	191
	3/8" Socket Set 6 pt TTI 19 Pieces	63	64" PRO35™ roller cabinet 15 drawers red	197
	3/8" Spark Plug Socket	463	ABS Top for 26" Cabinet	214
	3/8" Stud Extractor	476	Add On Panel Set Beside Cabinet	217
	3/8" T Bar Spark Plug Socket Set FOAMX4 5 Pieces	171	Add On Panel Set Between Cabinets	216
	3/8" T-Bar Deep Socket 6 pt Metric	270	Add On Panel Set for 37" Cabinet	217

Adjustable Brake Cylinder Honing Tool	465	Ball Point TX Key	391
Adjustable Engine Cylinder Honing Tool	465	Ball Point TX Key CR-MO	391
Adjustable Wrench	332	Ball Point TX Key Set 9 Pieces	392
Adjustable Wrench Alligator	332	Ball Point TX Key Set CR-MO 9 Pieces	393
Adjustable Wrench Set FOAM2 4 Pieces	155	Barn Style Tool Box	204
Adjustable Wrench Set TTI 4 Pieces	81	Barn Style Tool Box Tool Kit 187 Pieces	177
Adjustable Wrench TPR Grip	333	Bent Long Nose Plier	405
Adjustable Wrench Wide Jaw	333	Bent Long Nose Plier TPR Grip	405
Air Belt Sander	504	Bi-flex Wrench	328
Air Blow Gun	506	Bit Set IPR10 Pieces	368
Air Blow Gun	506	Bit Set With Belt Clip Mixed 28 Pieces	53,369
Air Drill	502	Bit Set With Belt Clip Mixed 29 Pieces	52,370
Air Engraving Pen	506	Bits Driver Set FOAM1 78 Pieces	161
Air Impact Wrench	500	Bits Driver Set TTI 38 Pieces	86
Air Needle Scaler	505	Bits Driver Set TTI 49 Pieces	85
Air Rivet Gun	505	Body Working Hammer	469
Air Saw	503	Bodywork Hammer Set TT4 5 Pieces	100
Aluminium Pipe Wrench	332,416	Bolt Cutter	403
Angled Ratcheting Bits Driver Set TTI 64 Pieces	87	Breaker Bar DIN3122	257
Angular Gauge	308	C Clamp Long Power Grip Plier	414
Automatic Centre Punch	493	C Clamp Power Grip Plier	413
Automotive Socket Set TTI 7 Pieces	99	C Clamp Power Grip Plier Non Pinch	413
Awl	460	Cabinet Cover Red	205
Awl Grey Handle	460	Cable Cutter	401
Back Pack Tool Box	204	Cable Cutter TPR Grip	401
Ball Joint Separator	466	Cable hook tool cabinet accessory	210
Ball Pein Hammer	491	Cable Tie Gun	482
Ball Point Hex & TX Key Set FOAM2 42 Pieces	162	Cable tie holder tool cabinet accessory	210
Ball Point Hex & TX Key Set TTI 28 Pieces	89	Cable/Wire Cutter	402
Ball Point Hex Key AF	383	Cantilever Tool Box	205
Ball Point Hex Key CR-MO AF	383	Carpenters Claw Hammer	491
Ball Point Hex Key CR-MO Metric	381	Carpenters Magnetic Claw Hammer	492
Ball Point Hex Key Metric	381	Carpenters Plier	403
Ball Point Hex Key Set 7 Pieces	386	Carpenters Shock Absorbent Claw Hammer	492
Ball Point Hex Key Set 9 Pieces	386	Centre Punch	493
Ball Point Hex Key Set A 9 Pieces	386	Chain Pipe Wrench	479
Ball Point Hex Key Set AF 7 Pieces	387	Circlip Plier Inner Bent PRO	410
Ball Point Hex Key Set AF 9 Pieces	388	Circlip Plier Inner Straight PRO	410
Ball Point Hex Key Set CR-MO 9 Pieces	387	Circlip Plier Interchangeable Tips	411
Ball Point Hex Key Set CR-MO AF 9 Pieces	388	Circlip Plier Outer Bent PRO	411
Ball Point Hex Screwdriver	341	Circlip Plier Outer Straight PRO	410

INDEX

	Circclip Plier Set PRO 10-25 mm TTI 4 Pieces	92		Crimping Plier	480
	Circclip Plier Set PRO 19-60 mm TTI 4 Pieces	92		Crimping Plier Set TTI 121 Pieces	101
	Circclip Plier Set PRO 40-100 mm TTX4 4 Pieces	92		Crimping Plier Set TTI 4 Pieces	102
	Circuit Tester	480		Curved Jaw Power Grip Plier	412
	Claw Pick Up Tool	485		Cutting Tool Set FOAM2 6 Pieces	170
	Clip & Panel Remover Set FOAM1 4 Pieces	172		Cutting Tool Set TT2 5 Pieces	95
	Clip & Panel Remover Set TTI 4 Pieces	98		Cutting Tool Set TT2 6 Pieces	95
	Clip & Panel Remover Tools	461		Dead Blow Hammer	469,492
	Clip Rail Set TTI 32 Pieces	55		Deadblow Hammer PU	469,492
	Combination Plier	404		Deburring Tool	479
	Combination Spanner AF	315		Deburring Tool Pocket Clip	479
	Combination Spanner Anti Slip Metric	319		Dial Gauge with Magnetic Stand	451
	Combination Spanner Metric	314		Die	440
	Combination Spanner Set 1 5/16"-1 7/8" Tool Roll 7 Pieces	318		Die Handle	441
	Combination Spanner Set 1/4"-3/4" Tool Roll 9 Pieces	318		Digital Calliper	450
	Combination Spanner Set 13/16"-1 1/4" Tool Roll 7 Pieces	318		Digital Multimeter	482
	Combination Spanner Set 20-32 mm Tool Roll 12 Pieces	317		Digital Torque Wrench	302
	Combination Spanner Set 33-50 mm Tool Roll 7 Pieces	318		Digital Torque Wrench	302
	Combination Spanner Set 5.5-19 mm Tool Roll 15 Pieces	317		Divider Set Large	206
	Combination Spanner Set 6-22 mm 17 Pieces	316		Divider Set Small	206
	Combination Spanner Set 6-22 mm Tool Roll 17 Pieces	317		Dolly	468
	Combination Spanner Set 6-32 mm Tool Roll 26 Pieces	317		Double Ended Mini Screwdriver Blade	337
	Combination Spanner Set 8-19 mm 12 Pieces	315		Double Ended Screwdriver Blade	342
	Combination Spanner Set 8-19 mm Tool Roll 10 Pieces	316		Double Flex Wrench AF	328
	Combination Spanner Set 8-19 mm Tool Roll 12 Pieces	316		Double Flex Wrench Metric	327
	Combination Spanner Set 8-19 mm Wall Rack 12 Pieces	178		Double Flex Wrench Set FOAM2 7 Pieces	155
	Combination Spanner Set AF TTI 8 Pieces	77		Double Flex Wrench Set TTI 6 Pieces	81
	Combination Spanner Set AF TTX4 7 Pieces	78		Double Flex Wrench Set Wall Rack 6 Pieces	178
	Combination Spanner Set Anti Slip FOAM2 12 Pieces	152		Double Open Ended Spanner AF	326
	Combination Spanner Set Anti Slip Tool Roll 12 Pieces	319		Double Open Ended Spanner Metric	326
	Combination Spanner Set Anti Slip TTI 12 Pieces	76		Double Open Ended Spanner Set AF TTX4 7 Pieces	80
	Combination Spanner Set FOAM2 15 Pieces	152		Double Open Ended Spanner Set Tool Roll 11 Pieces	327
	Combination Spanner Set FOAM4X4 31 Pieces	154		Double Open Ended Spanner Set TTI 8 Pieces	80
	Combination Spanner Set FOAMX4 7 Pieces	152		Double Ring Spanner AF	324
	Combination Spanner Set TTI 12 Pieces	77		Double Ring Spanner Metric	324
	Combination Spanner Set TTX4 6 Pieces	78		Double Ring Spanner Rigger Jigger 10 x 13mm	324
	Combination Spanner Set TTX4 7 Pieces	77		Double Ring Spanner Set AF Tool Roll 7 Pieces	325
	Combination Square	455		Double Ring Spanner Set AF TTX4 7 Pieces	80
	Composite Air Impact Wrench	501		Double Ring Spanner Set FOAMX4 8 Pieces	153
	Composite Air Impact Wrench	501		Double Ring Spanner Set Tool Roll 8 Pieces	325
	Crimping and Wire Stripping Plier	481		Double Ring Spanner Set TTX4 11 Pieces	79

Drain Plug	465	Folding Hex Key Set 2.5-10 mm 7 Pieces	389
Drill Bit Set 1.0-10.0 mm 28 Pieces	438	Folding Hex Key Set 2.5-10 mm ALU 7 Pieces	388
Drill Bit Set 1.0-13.0 mm 34 Pieces	439	Folding Hex Key Set AF 6 Pieces	390
Drill Bit Set 1.0-13.0 mm TT2 28 Pieces	96	Folding Hex Key Set AF 7 Pieces	389
Drill Bits Fully Ground	439	Folding Hex Key Set AF ALU 7 Pieces	389
Elastic Strap	494	Folding Key Set Mixed 8 Pieces	394
End Nipper	403	Folding TPX Key Set CR-MO 9 Pieces	393
Engineers Hammer	491	Folding TX Key Set 8 Pieces	393
Extension Bars Set FOAMX4 13 Pieces	142	Folding TX Key Set CR-MO 8 Pieces	394
Extension Bars Set TTX4 13 Pieces	68	Folding Utility Knife	443
Extra Long Ball Point Hex Key Metric	382	Folding Utility Saw	437
Extra Long Ball Point Hex Key Set CR-MO 9 Pieces	387	F-Type Clamp Fixed Handle	490
Extra Long Flexible Socket Driver	256	F-Type Clamp Swivel Handle	489
Extra Long Hex Key Metric	380	Gasket Scraper Grey Handle	460
Extra Long Hex Key Set 9 Pieces	386	Gauge Thread MM/UNC	451
Extractor & Nut Splitter Set TT1 11 Pieces	100	General Service Tool Set FOAM4X4 219 Pieces	136
Extractor and Nut Splitter Set FOAMX2 6 Pieces	172	General Tool Set BP FOAM3 6 Pieces	133
Feeler Gauge	451	General Tool Set BP FOAM3 7 Pieces	132
Fixing Bar	216	General Tool Set BP TT3 6 Pieces	58
Fixing brackets for tool chests PRO35™	207	General Tool Set BP TT4 9 Pieces	58
Flare nut Wrench AF	328	General Tool Set E FOAM3 6 Pieces	133
Flare nut Wrench Metric	328	General Tool Set E FOAM3 7 Pieces	132
Flaring Tool Set TT1 10 Pieces	100	General Tool Set E TT3 6 Pieces	59
Flat Cold Chisel	493	General Tool Set E TT4 9 Pieces	59
Flat Insulated Screwdriver	420	General Tool Set FOAM3 7 Pieces	132
Flat Jaw Power Grip Plier	412	General Tool Set FOAM4X4 15 Pieces	134
Flat Mini Screwdriver	336	General Tool Set FOAM4X4 15 Pieces	134
Flat Nose Plier	405	General Tool Set FOAM4X4 17 Pieces	134
Flat Nose Plier TPR Grip	406	General Tool Set FOAM4X4 18 Pieces	135
Flat Power Through Screwdriver	342	General Tool Set FOAM4X4 25 Pieces	135
Flat Screwdriver	339	General Tool Set FOAM4X4 28 Pieces	137
Flat Slim Insulated Screwdriver	420	General Tool Set FOAM4X4 37 Pieces	136
Flex Handle	257	Groove Joint Water Pump Plier	406
Flex Handle Offset	257	Hacksaw	437
Flex Handle Set FOAMX4 3 pieces	138	Hacksaw And Knife Set	436
Flex Handle Set TTX4 3 pieces	59	Hacksaw Blade Holder	438
Flexible Light With Magnet	487	Hand File	447
Flush Cut Plier	401	Hand File Set TTX4 5 Pieces	97
Folding Ball Point TX Key Set 8 Pieces	393	Hand File Set Wall Rack 5 Pieces	178
Folding Hex Key Set 1.5-6 mm 7 Pieces	389	Hand Rivet Gun	483
Folding Hex Key Set 1.5-6 mm ALU 7 Pieces	388	Hand Rivet Gun With Swivel Head	483

INDEX

Header	216	Impact Bit Set With Belt Clip TX 12 Pieces	130,371
Heavy Duty Cable Cutter	401	Impact Coupler Adaptor	283
Heavy Duty Cable Cutter Bi Material Handle	402	Impact Nut Setter Set With Belt Clip 5 Pieces	52,371
Heavy Duty Combination Plier	404	Impact Reducing Adaptor	283
Heavy Duty Combination Plier TPR Grip	404	Impact Step Up Adaptor	283
Heavy Duty Side Cutting Plier	400	Impact Universal Joint	283
Heavy Duty Side Cutting Plier TPR Grip	400	Insert Ratchet Head	305
Heavy Duty Side Cutting Plier With Spring	400	Insert Step Up Adaptor	260
Hex Bits 40mm	363	Insert Torque Wrench 14 x 18	302
Hex Bits 75mm	363	Insert Torque Wrench 9 x 12	303
Hex Key AF	382	Inspection Set TTI 3 Pieces	103
Hex Key Metric	380	Insulated Cable Cutter	425
Hex Key Set 9 Pieces	385	Insulated Combination Plier	424
Hex Key Set AF 10 Pieces	390	Insulated Handle for Interchangeable Blades	422
Hex Key Set AF Mini 7 Pieces	385	Insulated Interchangeable Blade Set FOAM1 10 Pieces	165
Hex Key Set Ball Point Metric 2 - 19 mm 13 Pieces	387	Insulated Interchangeable Blade Set Wallet 9 Pieces	423
Hex Key Set Metric Mini 7 Pieces	385	Insulated Knife	427
Hex Mini Screwdriver	336	Insulated Long Nose Plier	424
Hex Screwdriver	341	Insulated Plier & Knife Set FOAM2 8 Pieces	168
Hex Socket Adaptor	283	Insulated Plier & Screwdriver Set FOAM3 11 Pieces	167
Hex Socket Adaptor	283	Insulated Plier Set FOAM2 4 Pieces	168
Hinge Adjustment Wrench	491	Insulated Plier Set FOAM3 7 pieces	168
Hock & Pick Set TTI 4 Pieces	98	Insulated Plier Set TTI 4 Pieces	94
Hook & Pick Set With Belt Clip 4 Pieces	53	Insulated Screwdriver & Knife Set FOAM3 15 Pieces	167
Hook & Pin Wrench Set TTI 8 Pieces	81	Insulated Screwdriver Set Flat & PH 6 Pieces	423
Hook On Bit Set Mixed 22 Pieces	369	Insulated Screwdriver Set Flat FOAM1 4 Pieces	165
Hook On Tool Holder	214	Insulated Screwdriver Set FOAM3 12 Pieces	166
Hook On Tray	214	Insulated Screwdriver Set Interchangeable Blades TTI 10 Pieces	94
Hook On Tray for Cans	214	Insulated Screwdriver Set Mixed FOAM2 9 Pieces	166
Hook Tool	461	Insulated Screwdriver Set Mixed TTI 6 Pieces	93
Hook Tool	461	Insulated Screwdriver Set Mixed TTI 7 Pieces	93
Hook Tool Grey Handle	460	Insulated Screwdriver Set Mixed TT2 10 Pieces	94
Hook Wrench	330	Insulated Screwdriver Set PH/PZ FOAM1 4 Pieces	166
Hose Clamp	462	Insulated Side Cutting Plier	424
Hose Clamp Set TTI 3 Pieces	99	Insulated Socket & Pliers Set FOAM3 19 Pieces	170
Hose Clip Driver	462	Insulated Socket & Screwdriver Set FOAM3 28 Pieces	169
Impact Bit Set Construction With Belt Clip Mixed 12 Pieces	130,371	Insulated Spanner	428
Impact Bit Set FOAM1 50 Pieces	161	Insulated Spanner & Screwdriver Set FOAM3 17 Pieces	168
Impact Bit Set TTI 53 Pieces	88	Insulated Spanner Set FOAM2 12 Pieces	170
Impact Bit Set With Belt Clip Mixed 12 Pieces	130,371	Insulated Spanner Set FOAM3 17 Pieces	170
Impact Bit Set With Belt Clip Mixed 29 Pieces	52,370	Insulated Torque Screwdriver	300,423

Insulated Torque Screwdriver Set FOAM1 9 Pieces	151	Measuring Tape Metric	452
Insulated Torque Screwdriver Set FOAM3 27 Pieces	169	Measuring Tape Metric/Inch	452
Insulated Torque Screwdriver Set TT1 9 Pieces	94	Measuring Tool Set FOAM2 3 Pieces	171
Insulated Water Pump Plier	425	Measuring Tool Set TT1 4 Pieces	97
Insulated Wire Stripping Plier	425	Measuring Tool Set TT2 4 Pieces	98
Interchangeable Blade Insulated Screwdriver	422	MECCA PRO 1/2" Deep Impact Socket Set DIN 22 Pieces	246
Intricate Cutting Scissor	435	MECCA PRO 1/2" Deep Impact Socket Set DIN AF 18 Pieces	245
Kneeling Pad	495	MECCA PRO 1/2" Impact Socket Set DIN 22 Pieces	245
Knife Set TT1 40 Pieces	95	MECCA PRO 1/2" Impact Socket Set DIN 40 Pieces	246
L Bracket	216	MECCA PRO 1/2" Impact Socket Set DIN AF 18 Pieces	245
Lazy Tongue Rivet Gun	484	MECCA PRO 1/2" Socket & Tool Set 68 Pieces	236
LED Torch With Pocket Clip	486	MECCA PRO 1/2" Socket & Tool Set mm/AF 44 Pieces	236
Long Arm Ratchet Flex Head Set FOAMX4 3 pieces	138	MECCA PRO 1/2" Socket Set 12 pt 21 Pieces	234
Long Arm Ratchet Flex Head Set TTX4 3 pieces	60	MECCA PRO 1/2" Socket Set 12 pt AF 20 Pieces	234
Long Arm Ratchet Set FOAMX4 3 pieces	138	MECCA PRO 1/2" Socket Set 6 pt 21 Pieces	235
Long Arm Ratchet Set TTX4 3 pieces	59	MECCA PRO 1/2" Socket Set 6 pt 34 Pieces	235
Long Combination Spanner Metric	320	MECCA PRO 1/4" & 1/2" Socket & Tool Set 95 Pieces	240
Long Double Ring Spanner Metric	324	MECCA PRO 1/4" Socket Set 6 pt 60 Pieces	226
Long Double Ring Spanner Set FOAMX4 6 Pieces	153	MECCA PRO 1/4", 3/8" & 1/2" Socket & Tool Set mm/AF 127 Pieces	243
Long Double Ring Spanner Set TTX4 6 Pieces	80	MECCA PRO 1/4", 3/8" & 1/2" Socket Set 106 Pieces	241
Long Handled Nutsert Gun	484	MECCA PRO 1/4", 3/8" & 1/2" Socket Set mm/AF 111 Pieces	242
Long Handled Rivet Gun	484	MECCA PRO 3/4" Deep Impact Socket Set DIN 17 Pieces	247
Long Nose Plier	404	MECCA PRO 3/4" Deep Impact Socket Set DIN AF 21 Pieces	247
Long Nose Plier TPR Grip	405	MECCA PRO 3/4" Impact Socket Set DIN 17 Pieces	246
Long Nose Power Grip Plier	412	MECCA PRO 3/4" Impact Socket Set DIN AF 23 Pieces	247
Long Nose Power Grip Plier Non Pinch	412	MECCA PRO 3/4" Socket Set 6 pt 18 Pieces	239
Long Reach Plier	406	MECCA PRO 3/8" Socket & Tool Set 39 Pieces	229
Long Tin Snip	433	MECCA PRO 3/8" Socket & Tool Set 67 Pieces	230
Lump Hammer	491	MECCA PRO 3/8" Socket & Tool Set 80 Pieces	244
Magnetic Bits Tray	488	MECCA PRO 3/8" Socket & Tool Set mm/AF 48 Pieces	230
Magnetic Bracelet	485	MECCA PRO 3/8" Socket Set 6 pt 39 Pieces	229
Magnetic Claw Pick Up Tool	485	MECCA PRO 3/8" Socket Set 6 pt AF 35 Pieces	228
Magnetic LED Light Bar	487	MECCA PRO Insulated Screwdriver & Plier Set 18 Pieces	426
Magnetic Rack for Tyre Tools	494	MECCA PRO TC-6 Carrying Case	203
Magnetic Screwdriver Charger	343	MECCA PRO TC-6 FOAM Electrician Tool Kit 29 Pieces	126
Magnetic Shelf Red	208	MECCA PRO TC-6 FOAM Electrician Tool Kit 36 Pieces	125
Magnetic Side Shelf Red	208	MECCA PRO TC-6 FOAM Electrician Tool Kit 39 Pieces	126
Magnetic Tool Rail	211	MECCA PRO TC-6T FOAM Electrician Tool Kit 29 Pieces	124
Magnetic Tray for Cans Red	208	MECCA PRO TC-6T FOAM Electrician Tool Kit 37 Pieces	125
Magnetic Tray Red	208	MECCA PRO TC-6T FOAM Tool Kit 112 Pieces	124
Magnets with adhesive tape 2 Pieces	210	MECCA PRO TC-6T TT Mechanics Tool Kit 37 Pieces	48

INDEX

	MECCA PRO TC-6T TT Tool Kit 114 Pieces	47	Nut Driver Set TTX4 9 Pieces	89
	MECCA PRO TC-9 FOAM BP Tool Kit 118 Pieces	122	Nut Splitter Set	475
	MECCA PRO TC-9 FOAM Tool Kit 118 Pieces	121	Nutsert Gun	484
	MECCA PRO TC-9 FOAM Tool Kit 226 Pieces	123	Nutsert Gun Set TT1 81 Pieces	102
	MECCA PRO TC-9 FOAM Tool Kit 52 Pieces	123	Offset Tin Snip	432
	MECCA PRO TC-9 FOAM Tool Kit 56 Pieces	122	Offset Tin Snip	432
	MECCA PRO TC9 Service Case	203	Oil Filter Removal Plier	464
	MECCA PRO TC-9 TT Tool Kit 100 Pieces	46	Oil Filter Removal Tool Strap Type	464
	MECCA PRO TC-9 TT Tool Kit 113 Pieces	45	Oil Service Set TT1 16 Pieces	99
	MECCA PRO TC-9 TT Tool Kit 193 Pieces	46	Open End Slogging Wrench Metric	331
	MECCA PRO TC-9 TT Tool Kit 232 Pieces	45	Open Ended Insert Spanner 14 x 18	306
	MECCA PRO TC-9 TT Tool Kit E 100 Pieces	47	Open Ended Insert Spanner 9 x 12	305
	Mechanics Creeper	495	Paper Roll Holder	209
	Mechanics Work Chair	495	Paper roll holder for side handle	209
	Metric combination & ratcheting spanner set FOAM4X4 31 pieces	154	Parallel Pin Punch	493
	Micrometer	450	Parallel Pin Punch Set 6 Pieces	494
	Mini Bent Long Nose Plier	410	PH Insulated Screwdriver	420
	Mini Bolt Cutter	402	PH Mini Screwdriver	336
	Mini Bolt Cutter TPR Grip	402	PH Mini Screwdriver Pocket Clip	338
	Mini End Cutting Plier	408	PH Power Through Screwdriver	342
	Mini Flat Nose Plier	409	PH Screwdriver	340
	Mini Folding Utility Knife	443	PH Slim Insulated Screwdriver	420
	Mini Hacksaw	438	Pin Wrench	330
	Mini Long Nose Plier	409	Pipe Cutter 3-22mm	477
	Mini Needle Nose Plier	409	Pipe Cutter 3-32mm	477
	Mini Pliers & Screwdriver Set TT1 16 Pieces	84	Pipe Cutter 42mm Capacity PE Tubing	478
	Mini Round Nose Plier	409	Pipe Cutter Chain Type	478
	Mini Screwdriver Handle	337	Pipe Cutter Set TT1 6 Pieces	102
	Mini Screwdriver Set Flat & PH 6 Pieces	337	Plastic Magnetic Bowl	488
	Mini Screwdriver Set Mixed 8 Pieces	337	Plastic Tool Box	204
	Mini Screwdriver Set TX 6 Pieces	338	Plier Set FOAM4X4 11 Pieces	163
	Mini Side Cutting Plier	408	Plier Set Q FOAM4X4 13 Pieces	164
	Mini TX Key	338	Plier Set Tool Roll 5 Pieces	408
	Mini TX T-Handle Screwdriver Set 6 Pieces	338	Plier Set TPR Grip Q FOAM2 5 Pieces	163
	Mobile Tool Panel	218	Plier Set TPR Grip Q TT1 4 Pieces	91
	Needle File	445	Plier Set TPR Grip TT1 4 Pieces	90
	Needle File	445	Plier Set Vinyl Grip Q FOAM2 5 Pieces	163
	Needle File Set TT1 12 Pieces	97	Plier Set Vinyl Grip Q FOAM4X4 14 Pieces	164
	Non Slip Mat Roll	206	Plier Set Vinyl Grip Q TT1 4 Pieces	90
	Nut Driver	343	Plier Set Vinyl Grip Q TT2 8 Pieces	91
	Nut Driver & Hex/TX T-Handle Set FOAM4X4 23 Pieces	163	Plier Set Vinyl Grip TT1 3 Pieces	90



















Plier Set Vinyl Grip TTI 4 Pieces	90	Ratcheting Combination Spanner AF R	321
Plumber Tool Set FOAM3 7 Pieces	133	Ratcheting Combination Spanner Metric RF	323
Plus/Minus Insulated Screwdriver	421	Ratcheting Combination Spanner Metric RS	322
Power Grip Plier Set	413	Ratcheting Combination Spanner Set R AF TTI 8 Pieces	79
Power Grip Plier Set FOAM4X4 11 Pieces	165	Ratcheting Combination Spanner Set R FOAM2 12 Pieces	153
Power Grip Plier Set FOAMX2 3 Pieces	165	Ratcheting Combination Spanner Set R Tool Roll 8 Pieces	322
Power Grip Plier Set TTI 5 Pieces	92	Ratcheting Combination Spanner Set R TTI 11 Pieces	78
Power Grip Plier Set TT4 4 Pieces	93	Ratcheting Combination Spanner Set R TTI 8 Pieces	78
Power Grip Plier Set TTX2 3 Pieces	93	Ratcheting Combination Spanner Set RF TTI 8 Pieces	79
Power Through Screwdriver Set FOAMX4 5 Pieces	160	Ratcheting Construction Wrench	329
Power Through Screwdriver Set TTX4 5 Pieces	84	Ratcheting Crimping Plier	481
Power Through Screwdriver Set Wall Rack 5 Pieces	179	Ratcheting Crimping Plier With Three Heads	480
Power Tool Shelf	209	Ratcheting Multi Drive Ring Spanner	329
PRO35™ Side Cupboard Red	203	Ratcheting Offset Ring Spanner Metric	329
Pry Bar	477	Ratcheting Offset TX-E Ring Spanner	329
Pry Bar Roll Heel Type	477	Ratcheting Ring Spanner Set TTI 6 Pieces	81
Pry Bar Set Roll/Heel FOAMX4 4 Pieces	171	Ratcheting Screwdriver Bit Set TTI 74 Pieces	86
Pry Bar Set Roll/Heel TTX4 3 Pieces	101	Ratcheting Screwdriver Set TTI 15 Pieces	82
Pry Bar Set TTX4 3 Pieces	101	Ratcheting Wire Stripping Plier	481
Puller Set TTI 4 Pieces	100	Rechargeable Flashlight LED 1200 Im	486
Puller Set With Stand	474	Rechargeable Headlamp 350 Im	487
Punch & Chisel Set 5 Pieces	494	Rechargeable Headlamp 400 Im	487
Punch & Chisel Set FOAM2 14 Pieces	172	Rechargeable Lamp Set TTI 3 Piece	103
Punch & Chisel Set TTI 9 Pieces	103	Rechargeable Worklight 1000 Im	487
PZ Insulated Screwdriver	421	Reducing Adaptor	259
PZ Screwdriver	340	Repair Kit 1200F, 1200L & 1200-45E	255
PZ Slim Insulated Screwdriver	421	Repair Kit 1201/1201A	257
Quick Action Utility Knife	443	Repair Kit 1400F & 1400L	255
Quick Clamp Bottom Lever	489	Repair Kit 3800-41E	255
Quick Clamp Top Lever	489	Repair Kit 3800F, 3800L	255
Quick Set Pliers Wrench	332	Repair Kit 72 Teeth Ratchet	255
Quick Set Water Pump Plier	407	Repair Kit 72 Teeth Ratchet IP5X	255
Quick Set Water Pump Plier HRC60	407	Repair Kit for M140012-C	257
Quick Set Water Pump Plier TPR Grip HRC60	408	Repair Kit for M380012-C	257
Quick Wrench	330	Repair Kit FRP Ratchet	255
Ratchet 72 Teeth	253	Repair Kit M1100	255
Ratchet 72 Teeth Flexible Head	253	Repair Kit M110070	257
Ratchet 72 Teeth IP5X	253	Repair Kit M110072	255
Ratchet Clamp	490	Repair Kit M120010	257
Ratchet Heavy Duty	254	Repair Kit M340070/M340070S	257
Ratcheting Bits Driver Set TTI 84 Pieces	85	Repair Kit M3400-72	255

INDEX

Replacement Blade Gun Saw	437	Screwdriver Set Flat & PH TTX4 8 Pieces	83
Replacement Blade Hacksaw	437-438	Screwdriver Set Flat FOAM1 4 Pieces	156
Replacement Blade Mini Hacksaw	438	Screwdriver Set Mixed 10 Pieces	344
Replacement Blades Deburring Tool	479	Screwdriver Set Mixed 11 Pieces	345
Replacement Blades For Insulated Knife	427	Screwdriver Set Mixed 12 Pieces	346
Replacement Blades Mini Folding Utility Knife	443	Screwdriver Set Mixed 54 Pieces	344
Replacement Blades Pipe Cutter	478	Screwdriver Set Mixed 6 Pieces	345
Replacement Blades Rotating Pipe Cutter	477	Screwdriver Set Mixed FOAM2 11 Pieces	156
Replacement Blades Rotating Pipe Cutter	477	Screwdriver Set Mixed FOAM4X4 114 Pieces	159
Replacement Blades Utility Knife	444	Screwdriver Set Mixed FOAM4X4 115 Pieces	137
Replacement Hook Blades Utility Knife	444	Screwdriver Set Mixed FOAM4X4 122 Pieces	158
Replacement Pipe Cutter Chain	478	Screwdriver Set Mixed FOAM4X4 98 Pieces	158
Replacement Snap Off Blades 18mm	442	Screwdriver Set Mixed TT1 7 Pieces	82
Replacement Snap Off Blades 9mm	442	Screwdriver Set Mixed TT2 14 Pieces	83
Retaining Pin	284	Screwdriver Set Mixed with Magnetic Charger TT1 5 Pieces	82
Retaining Ring	284	Screwdriver Set PH/PZ FOAM1 4 Pieces	156
Ring End Slogging Wrench Metric	331	Screwdriver Set TX & TPX TT1 7 Pieces	83
Ring Ended Insert Spanner 14 x 18	307	Screwdriver Set TX 4 FOAM1 Pieces	156
Ring Ended Insert Spanner 9 x 12	306	Screwdriver Set TX FOAM2 9 Pieces	157
Rivet Gun Set FOAM1 81 Pieces	172	Screwdriver Set TX TT2 12 Pieces	83
Rivet Gun Set TT1 81 Pieces	102	Scriber	484
ROB Insulated Screwdriver	421	Scriber With Carbide Tip	484
ROB Screwdriver	342	Sheet Metal Power Grip Plier	415
Rotating Pipe Cutter	479	Side Cutting Plier	400
Rotating Spinner Handle	256	Side Cutting Plier TPR Grip	400
Round Nose Plier	406	Side Panel for Cabinet	212
Safety Glasses	496	Side Panel with Stand	213
Safety Glasses Sport Style	496	Side shelf for roller cabinet 457 x 100 x 50mm	210
Safety Utility Knife	443	Side Shelf for Vice	209
Scissor	435	Sliding Bevel	454
Scraper Set TT1 4 Pieces	98	Sliding T Bar	260
Screw Clamp	489	Snap Off Knife 18 mm	442
Screw Extractor	474	Snap Off Knife 9 mm	441
Screw Extractor Set Spiral 5 Pieces	475	Snap Off Knife 9 mm	441
Screw Extractor Set With Belt Clip 5 Pieces	54,475	Snap Off Knife Set 4 Pieces	441
Screwdriver & Hex/TX Key Set 1 FOAM3 54 Pieces	159	Socket & Bit Set Flexible Handle TTX4 41 Pieces	87
Screwdriver & Hex/TX Key Set 2 FOAM3 54 Pieces	160	Socket & Combination Spanner Set AF FOAM4X4 62 Pieces	155
Screwdriver & Spanner Set FOAM4X4 33 Pieces	157	Socket Adaptor Set TT1 17 Pieces	70
Screwdriver Blade Set Mixed TT1 12 Pieces	84	Socket Clip Rail	213
Screwdriver Set Flat & PH 6 Pieces	345	Socket Clips	213
Screwdriver Set Flat & PH FOAMX4 5 Pieces	157	Soft Face Hammer	492





Spanner & File Set FOAM4X4 32 Pieces	154	Straight Air Impact Wrench	501
Spanner & Socket Set FOAM3 57 Pieces	142	Stubby Combination Spanner Metric	319
Spanner Ring	326	Stubby Combination Spanner Set TTI 10 Pieces	77
Spanner Set FOAM4X4 15 Pieces	154	Stubby Ratcheting Combination Spanner Metric RS	323
Spanner Set FOAM4X4 37 Pieces	153	Stubby Ratcheting Combination Spanner Set TTI 10 Pieces	79
Spare Part For Locks	211	Stubby Screwdriver Set FOAMX2 6 Pieces	157
Spare Part For Locks	211	Stud Extractor Set TTI 18 Pieces	101
Spare Parts for Tool Box Key TCDRK	211	Suction Lifter	468
Spark Plug Boot Plier	463	Sun Glasses	497
Spark Plug Thread Cleaner	463	Support Leg	216
Special Auto Sockets	466	Swivel C Clamp Long Power Grip Plier	414
Speed Brace	257	Swivel C Clamp Power Grip Plier	414
Spinner Handle	256	Swivel C Clamp Power Grip Plier Non Pinch	413
Spirit Level Magnetic	453	Swivel Clamping Power Grip Plier	415
Square Base	455	Swivel Clamping Power Grip Plier Non Pinch	415
Stack Cover Red	206	T Handle Ball Point Hex Key AF	385
Stainless steel work top	215	T Handle Ball Point Hex Key Metric	384
Steel Rule	451	T Handle Hex Key Metric	384
Step Up Adaptor	259	T Handle Nut Driver	343
Step Up Adaptor Set 4 Pieces	260	T Handle TX Key	392
Storage Tray FOAM1 2 Compartments	131	Table Clamp	415
Storage Tray FOAM1 7 Compartments	130	Tap	440
Storage Tray FOAM2 4 Compartments	131	Tap and Die Set TTI 17 Pieces	96
Storage Tray FOAM2 8 Compartments	131	Tap and Die Set TT2 34 Pieces	96
Storage Tray FOAMX2 3 Compartments	132	Tap Handle	441
Storage Tray FOAMX4 4 Compartments	131	T-Bar Handle	261
Storage Tray For TJ Sets TTI	54	Telescopic Basin Tap Wrench	330,416
Storage Tray TTI 2 Compartments	55	Telescopic Inspection Mirror	485
Storage Tray TTI 4 Compartments	56	Telescopic Inspection Tool 3 in 1	486
Storage Tray TTI 6 Compartments	56	Telescopic Magnetic Pick Up Tool And Pen	486
Storage Tray TTI 7 Compartments	55	Telescopic Magnifying Glass	485
Storage Tray TT2 16 Compartments	57	Telescopic Pick Up Tool 550mm	486
Storage Tray TT2 4 Compartments	56	Telescopic Pick Up Tool 760mm	485
Storage Tray TT2 8 Compartments	56	T-Handle Ball Point Hex Key Set AF TTI 7 Pieces	89
Storage Tray TTX2 6 Compartments	58	T-Handle Ball Point Hex Key Set FOAM2 7 Pieces	162
Storage Tray TTX4 1 Compartment	57	T-Handle Ball Point Hex Key Set TTI 7 Pieces	88
Storage Tray TTX4 4 Compartments	57	T-Handle Ball Point TX Key Set FOAM2 7 Pieces	162
Storage Tray TTX4 6 Compartments	57	T-Handle Hex Key Set TTI 7 Pieces	88
Storage Tray TTX4 8 Compartments	58	T-Handle TX/TPX Key Set TTI 7 Pieces	89
Storage Tray With Tool Holder TTI	55	T-Handle TX/TPX Key Set Wall Rack 7 Pieces	179
Straight Air Die Grinder	504	Three Arm Quick Action Puller	473





INDEX

	Three Arm Universal Puller	473	Upright 1.6m	216
	Tin Snip	432	Upright Long	216
	Tin Snip Compact	434	Upright Short	216
	Tin Snip High Leverage	433	Utility Knife	444
	Tin Snip High Leverage	433	Vernier Calliper	450
	Tool Bag	205	Voltage Tester	480
	Tool Box Fixing Brackets	207	Wall Hanging Tool Cabinet 1800 mm	219
	Tool Cabinet	219	Water Pump Plier	407
	Tool Hooks	213	Water Pump Plier TPR Grip	407
	Tool Panel	216	Welding Magnet	488
	Tool panel kit 16 pieces red	177	Welding Power Grip Plier	414
	Tool Panel Set for 26" Cabinet	216	Wheel Tool Set FOAMx4 5 Pieces	171
	Top Box Cover Red	205	Wing Cover	468
	Torch Pocket Clip	486	Wire Stripping Plier Gun Type	481
	Torpedo Spirit Level	453	Wire Stripping Plier TPR Grip	482
	Torque Multiplier 1:10	309	Wire Twisting Plier	482
	Torque Multiplier 1:3	308	Work Bench	219
	Torque Multiplier Support Leg	308	Work Bench Fixing Bar	219
	Torque Screwdriver Set FOAM1 38 Pieces	151	Work Bench Legs	219
	Torque Screwdriver Set FOAM2 95 Pieces	150	Work Bench Panel	219
	Torque Screwdriver Set TT1 38 Pieces	75	Work Bench Square Tube	219
	Torque Spanner Set 4 Pieces	308	Work Bench Upright	219
	Torque Tester Stand	309	Work Bench Wheel Set	219
	Tower Pincer Plier	403	Work Bench Work Top	219
	TPX Key CR-MO	392	Work Top	215
	TPX Screwdriver	341		
	Trolley for Side Cabinet	218		
	Trolley for Tool chest	218		
	Try Square	454		
	Twist Extractor Set 8-13 mm 5 Piece	53		
	Two Arm Quick Action Puller	473		
	Two Arm Universal Puller	473		
	Two/Three Arm Gear Puller	472		
	TX Bits 75mm	360		
	TX Key	390		
	TX Key Set 7 Pieces	394		
	TX Key Set 9 Pieces	392		
	TX Mini Screwdriver	336		
	TX Screwdriver	341		
	Tyre Lever	466		
	Universal Joint	258		











INDEX

		PAGE			PAGE			PAGE			PAGE
1101	£242.90	257	1292P418	£246.00	302	1479MMJ	£99.90	387	210812	£8.90	363
1192P1000	£1,299.00	305	1292P418-CT	£306.00	302	1479MMR	£16.20	385	210814	£11.60	363
1192P1500	£1,790.00	305	1292P912	£234.00	303	1479MMRL	£28.20	386	210817	£15.40	363
1192P2000	£2,219.00	305	1292P912-CT	£294.00	303	1479TX	£35.60	392	210819	£17.90	363
1200-45E	£87.30	254	1400-72MN	£51.50	252	1479TX1	£45.10	392	220720	£6.10	360
1200-72NRK	£36.70	255	1400-72N	£57.90	253	1487	£22.90	394	220725	£6.10	360
1200-72SN	£81.20	253	1400-72NRK	£28.50	255	1488	£17.40	368	220727	£6.10	360
1200-72U	£82.60	253	1400-72SN	£62.10	253	1492AG-CT	£159.60	300	220730	£6.10	360
1200-72URK	£22.30	255	1400-72U	£64.20	253	1492AG-E	£99.50	300	220740	£6.10	360
1200F	£65.00	254	1400-72URK	£16.20	255	1492P015	£144.00	300	220745	£6.10	360
1200FRK	£28.40	255	1400B	£38.30	372	1492P030	£144.00	300	220750	£6.10	360
1200FRP	£66.50	253	1400F	£50.90	254	1492TSD	£138.00	300	220755	£6.10	360
1200FRPRK	£27.30	255	1400FRK	£16.20	255	1492TSD-CT	£198.00	300	220760	£6.90	360
1200L	£63.20	254	1400FRP	£40.50	253	1492TVSD	£162.20	300,423	220770	£9.00	360
1201	£51.90	257	1400FRPRK	£19.00	255	1492TVSD-CT	£222.20	300,423	220820	£8.40	360
1201A	£80.50	257	1400L	£41.70	254	1498TPX	£47.90	393	220825	£8.40	360
1201ARK	£23.20	257	1400M	£38.50	252	1499AF	£34.40	388	220827	£8.40	360
1202	£31.40	467	1424	£10.90	390	1499MM	£34.40	387	220830	£8.40	360
120955-C	£13.60	278	1471AF	£15.30	389	1499MML	£43.90	387	220840	£8.40	360
1292AG4-CT	£269.90	301	1471AFA	£19.90	390	1499TX	£54.50	393	220845	£8.40	360
1292AG4R-CT	£296.90	302	1471MM	£15.60	389	210705	£6.10	363	220850	£8.40	360
1292AG-E4	£209.90	301	1471MMA	£19.90	389	210706	£6.10	363	220855	£8.40	360
1292AG-E4R	£236.90	302	1474	£23.60	387	210707	£6.10	363	220860	£9.20	360
1292AG-EP	£119.90	301	1475	£23.60	386	210708	£6.10	363	220870	£12.70	360
1292AG-ER	£148.90	302	1476NAF	£20.30	389	210709	£6.10	363	2300	£56.90	476
1292AGP-CT	£179.90	301	1476NMM	£20.50	388	210710	£6.10	363	2912512	£7.70	337
1292AGR-CT	£208.90	302	1476NMM1	£23.20	388	210712	£6.50	363	2912513	£7.70	337
1292CQ200R	£51.30	305	1476NTX	£29.10	393	210714	£8.10	363	2912514	£7.70	337
1292D200	£719.90	302	1476NTX1	£40.40	393	210717	£10.10	363	2912520	£7.70	337
1292D200-CT	£779.90	302	1476NTX2	£28.80	394	210719	£12.00	363	2912535	£7.70	337
1292P100	£213.90	302	1477AF	£8.50	385	210805	£8.40	363	2912537	£7.70	337
1292P100-CT	£273.90	302	1477MM	£8.50	385	210806	£8.40	363	2912539	£7.70	337
1292P200	£222.00	302	1477NX	£33.20	394	210807	£8.40	363	310102	£1.30	382
1292P200-CT	£282.00	302	1479AF	£28.20	388	210808	£8.40	363	3101025	£1.30	382
1292P320	£334.00	302	1479MM	£27.40	386	210809	£8.40	363	3101025BL	£3.50	383
1292P320-CT	£394.00	302	1479MMA	£27.20	386	210810	£8.40	363	310103	£1.30	382





		PAGE			PAGE			PAGE			PAGE
3101035	£1.30	382	310505BL-C	£4.00	381	320025BL	£6.80	391	3800-72NRK	£29.50	255
310103BL	£4.30	383	310506	£2.20	380	320027	£5.80	390	3800-72U	£72.40	253
310104	£1.30	382	310506BL-C	£4.40	381	320027BL	£6.80	391	3800-72URK	£20.30	255
3101045	£1.30	382	310507	£2.70	380	320030	£6.20	390	3800F	£61.60	254
310104BL	£4.30	383	310507BL-C	£5.60	381	320030BL	£7.00	391	3800FRK	£18.50	255
310105	£1.80	382	310508	£2.90	380	320040	£6.80	390	3800FRP	£51.90	253
310105BL	£4.40	383	310508BL-C	£6.00	381	320040BL	£7.40	391	3800FRPRK	£22.30	255
310106	£1.80	382	310509	£3.20	380	320045	£8.10	390	3800L	£52.30	254
310106BL	£4.70	383	310510	£4.00	380	320045BL	£9.30	391	3892AG1-CT	£159.90	301
310107	£1.90	382	310510BL-C	£8.10	381	320050	£9.20	390	3892AG3-CT	£174.90	301
310107BL	£5.20	383	310511	£6.50	380	320050BL	£10.00	391	3892AG-E1	£99.90	301
310108	£2.00	382	310512	£6.70	380	3205015	£2.00	380	3892AG-E3	£114.90	301
310108BL	£5.50	383	310512BL-C	£14.60	381	320502	£2.00	380	3892CQ100R	£47.90	305
310110	£2.80	382	310514	£9.30	380	3205025	£2.40	380	3892D100	£629.90	301
310110BL	£7.10	383	310514BL-C	£22.60	381	320503	£2.50	380	3892D100-CT	£689.90	301
310112	£3.40	382	310516	£14.30	380	320504	£2.80	380	3892P030	£152.90	301
310112BL	£8.80	383	310517	£15.20	380	320505	£3.10	380	3892P060	£196.90	301
310114	£6.40	382	310517BL-C	£34.70	381	320506	£3.70	380	3892P060-CT	£256.90	301
310116	£8.30	382	310518	£21.70	380	320508	£5.00	380	3892P100	£206.90	301
310120	£15.10	382	310519	£21.20	380	320510	£7.00	380	3892P100-CT	£266.90	301
3105007	£1.50	380	310519BL-C	£49.60	381	3401	£219.90	257	3901025BL	£4.00	383
3105009	£1.50	380	310522	£32.60	380	3492AG1-CT	£876.00	303	390103BL	£4.50	383
3105013	£1.50	380	310527	£59.10	380	3492AG2-CT	£1,047.00	303	390104BL	£5.10	383
3105015	£1.50	380	310532	£107.00	380	3492AG-CT	£363.00	303	390105BL	£5.10	383
3105015BL-C	£3.30	381	310536	£146.00	380	3492AG-E	£303.00	303	390106BL	£5.40	383
310502	£1.60	380	320008	£4.70	390	3492AG-E1	£816.00	303	390107BL	£5.70	383
3105025	£1.50	380	320008BL	£6.30	391	3492AG-E2	£987.00	303	390108BL	£6.20	383
3105025BL-C	£3.30	381	320009	£4.70	390	3492AG-ER	£338.00	304	390110BL	£8.00	383
310502BL-C	£3.30	381	320009BL	£6.30	391	3492AGR-CT	£398.00	304	390112BL	£9.70	383
310503	£1.60	380	320010	£5.00	390	3492CQ500R	£180.90	305	3905015BL	£3.70	381
310503BL-C	£3.30	381	320010BL	£6.30	391	3492P1000	£1,253.00	304	3905025BL	£4.00	381
310504	£2.00	380	320015	£5.20	390	3492P500	£499.00	304	390502BL	£3.80	381
3105045	£2.00	380	320015BL	£6.30	391	3492P500-CT	£559.00	304	390503BL	£4.00	381
310504BL-C	£3.70	381	320020	£5.30	390	3800-41E	£63.60	254	390504BL	£4.00	381
310505	£2.20	380	320020BL	£6.80	391	3800-41ERK	£18.30	255	390505BL	£4.70	381
3105055	£2.10	380	320025	£5.70	390	3800-72MN	£59.10	253	390506BL	£5.00	381





INDEX

		PAGE			PAGE			PAGE			PAGE
390508BL	£6.70	381	4003WT	£46.20	333	410P	£46.60	415	510510	£20.20	384
390510BL	£8.80	381	4004	£36.20	332	410SP	£47.40	415	510512	£23.00	384
3908015BL	£3.10	382	4004IQ	£44.10	333	418S	£73.20	414	5106025	£8.90	384
3908020BL	£3.10	382	4004WT	£63.60	333	418SP	£74.70	414	510603	£8.80	384
3908025BL	£3.60	382	4005	£45.50	332	445W	£139.90	408	510604	£9.00	384
390803BL	£4.30	382	4005IQ	£54.50	333	480	£26.20	411	510605	£9.70	384
390804BL	£4.50	382	4005WT	£100.50	333	490	£31.80	432	510606	£10.10	384
390805BL	£5.20	382	4006	£91.90	332	490W	£32.40	433	510607	£12.40	384
390806BL	£5.80	382	4006IQ	£112.90	333	491	£31.80	432	510608	£12.50	384
390808BL	£7.60	382	4007	£149.90	332	491-7N	£37.60	434	520009	£8.80	392
390808TPX	£5.20	392	4008	£325.90	332	491W	£32.40	433	520010	£8.80	392
390809TPX	£5.20	392	401-10	£24.80	412	492	£31.80	432	520015	£8.80	392
390810BL	£10.30	382	401-10F	£24.80	412	492W	£32.90	434	520020	£8.80	392
390810TPX	£5.60	392	401-12	£33.00	412	493	£43.90	432	520025	£9.80	392
390815TPX	£5.80	392	401-12F	£33.00	412	493-7N	£37.60	434	520027	£9.80	392
390820TPX	£6.20	392	401-4	£19.00	412	494	£43.90	433	520030	£11.00	392
390825TPX	£6.80	392	401-5	£20.40	412	494-7N	£37.60	434	520040	£11.80	392
390827TPX	£7.00	392	401-7	£21.50	412	495	£35.90	433	520045	£12.80	392
390830TPX	£7.40	392	402	£46.50	413	496	£38.10	402	520055	£18.90	392
390840TPX	£8.10	392	404-4	£21.20	412	497	£41.40	435	580	£24.40	488
390908BL	£7.20	391	404-6	£22.80	412	498-7N	£37.60	402	580A	£52.90	488
390909BL	£7.20	391	404-6S	£22.80	412	510103	£9.30	385	580CM	£76.50	208
390910BL	£7.30	391	404-9	£26.50	412	510104	£9.70	385	580CN	£96.50	208
390915BL	£7.30	391	406	£37.40	413	510105	£9.90	385	580D	£46.80	208
390920BL	£7.80	391	406-6	£29.70	413	510106	£10.70	385	580J	£77.90	208
390925BL	£7.80	391	406-6P	£31.70	414	510107	£11.50	385	580K	£73.90	208
390927BL	£7.90	391	406-6S	£25.80	413	510108	£13.30	385	580M	£83.10	208
390930BL	£8.10	391	406-6SP	£31.70	413	510110	£13.70	385	580N	£97.40	208
390940BL	£8.50	391	406P	£47.80	414	510502	£8.70	384	580Q	£18.40	488
4001	£23.20	332	406S	£36.40	413	5105025	£8.90	384	580S	£68.80	488
4002	£24.30	332	406SP	£48.10	413	510503	£8.70	384	580T	£54.90	210
4002IQ	£29.80	333	407	£37.60	414	510504	£8.80	384	581N1	£48.10	486
4002WT	£41.90	333	408	£37.20	415	510505	£9.70	384	581TMG	£28.50	485
4003	£29.10	332	409	£34.90	464	510506	£10.20	384	581TMI	£27.60	485
4003IQ	£35.50	333	409P	£46.80	415	510507	£12.60	384	581TMP	£29.90	485
4003J	£47.30	332	409SP	£47.90	415	510508	£13.00	384	582MI	£30.90	486





		PAGE			PAGE			PAGE			PAGE
583M	£20.30	485	600142	£48.20	315	600514R	£29.50	321	600527	£27.30	314
584N	£76.40	486	600144	£51.30	315	600514RF	£37.60	323	600527R	£108.90	321
585	£38.70	486	600146	£67.20	315	600514RS	£28.80	322	600528	£29.10	314
585MP	£21.70	486	600148	£72.50	315	600515	£10.30	314	600529	£30.40	314
586	£74.00	487	600152	£88.50	315	600515R	£30.30	321	600530	£31.60	314
586D	£21.30	487	600156	£135.90	315	600515RF	£37.20	323	600530R	£128.90	321
586N	£51.90	487	600160	£147.90	315	600515RS	£31.80	322	600532	£33.60	314
587J	£93.00	487	6005055	£7.80	314	600516	£11.60	314	600532R	£149.90	321
588N	£66.20	487	600506	£7.80	314	60051619RX	£78.10	329	600533	£43.80	314
600	£8.30	326	600507	£7.80	314	600516R	£33.20	321	600534	£45.30	314
600108	£8.30	315	600507RF	£28.00	323	600516RS	£33.20	322	600536	£59.90	314
600110	£8.30	315	600508	£7.80	314	600517	£12.30	314	600538	£69.80	314
600110R	£27.90	321	600508R	£21.90	321	600517R	£33.20	321	600541	£79.20	314
600112	£8.40	315	600508RF	£28.00	323	600517RF	£40.30	323	600546	£112.90	314
600112R	£29.90	321	600508RS	£22.40	322	600517RS	£35.00	322	600550	£130.90	314
600114	£8.70	315	600509	£8.30	314	600518	£13.70	314	600555	£324.00	314
600114R	£31.90	321	600509R	£21.90	321	600518R	£35.90	321	600558	£407.00	314
600116	£9.90	315	600509RF	£28.80	323	600518RF	£42.60	323	600560	£416.00	314
600116R	£35.50	321	600509RS	£22.60	322	600518RS	£37.20	322	600565	£580.00	314
600118	£10.40	315	600510	£8.40	314	600519	£14.20	314	600570	£587.00	314
600118R	£36.90	321	600510R	£23.50	321	600519R	£36.50	321	6005M10	£8.00	319
600120	£11.90	315	600510RF	£30.20	323	600519RF	£43.90	323	6005M10RS	£20.80	323
600120R	£41.90	321	600510RS	£23.00	322	600519RS	£38.00	322	6005M11	£8.70	319
600122	£13.80	315	600511	£8.50	314	600520	£15.60	314	6005M11RS	£21.40	323
600122R	£41.90	321	600511R	£25.20	321	600520RS	£39.90	322	6005M12	£9.50	319
600124	£15.10	315	600511RF	£32.00	323	600521	£15.90	314	6005M12RS	£22.10	323
600124R	£46.50	321	600511RS	£23.60	322	600521RS	£42.10	322	6005M13	£9.60	319
600126	£17.00	315	600512	£8.70	314	600522	£17.90	314	6005M13RS	£23.20	323
600126R	£62.50	321	600512R	£27.40	321	600522R	£49.90	321	6005M14	£10.10	319
600128	£20.40	315	600512RF	£34.30	323	600522RS	£43.20	322	6005M14RS	£23.90	323
600128R	£62.50	321	600512RS	£24.60	322	600523	£20.40	314	6005M15	£10.80	319
600130	£23.20	315	600513	£9.00	314	600524	£21.30	314	6005M15RS	£24.60	323
600132	£27.80	315	600513R	£28.10	321	600524R	£59.90	321	6005M16	£11.60	319
600134	£30.40	315	600513RF	£35.10	323	600524RS	£44.90	322	6005M16RS	£25.60	323
600136	£33.00	315	600513RS	£25.90	322	600525	£23.60	314	6005M17	£12.90	319
600140	£37.60	315	600514	£10.10	314	600526	£25.10	314	6005M17RS	£27.30	323





INDEX

		PAGE			PAGE			PAGE			PAGE
6005M18	£13.80	319	623032	£28.30	326	6512N	£107.50	315	690513	£28.90	305
6005M18RS	£28.10	323	630607	£11.30	324	651415	£35.50	327	690514	£28.90	305
6005M19	£14.50	319	630809	£11.60	324	6515MM	£133.50	317	690515	£28.90	305
6005M19RS	£29.70	323	630810FL	£31.20	324	651617	£37.90	327	690516	£28.90	305
600813	£45.70	330	6308MM	£115.50	325	6517	£159.30	316	690517	£28.90	305
600814	£56.30	330	631011	£12.60	324	6517MM	£179.90	317	690518	£28.90	305
600816	£56.90	330	631113FL	£39.80	324	651819	£42.70	327	690519	£28.90	305
600817	£57.90	330	631213	£13.50	324	6526MM	£379.90	317	690613	£30.90	306
600822	£68.90	330	631214FL	£40.30	324	661416	£10.30	328	690614	£30.90	306
600824	£79.90	330	631415	£15.40	324	663032	£7.40	326	690615	£30.90	306
600827	£106.70	330	631617	£15.80	324	663436	£10.10	326	690616	£30.90	306
600830	£109.20	330	631618FL	£50.40	324	663840	£11.10	326	690617	£30.90	306
601013	£13.90	324	631719FL	£51.40	324	664244	£14.10	326	690618	£30.90	306
605908	£10.20	320	631819	£18.40	324	664648	£15.50	326	690619	£30.90	306
605909	£10.20	320	632022	£23.30	324	665052	£26.00	326	690621	£32.70	306
605911	£10.60	320	632123	£26.10	324	665456	£33.00	326	690622	£32.70	306
605912	£11.00	320	632224FL	£67.30	324	6707AF	£166.90	325	690624	£32.70	306
605914	£14.00	320	632427	£29.50	324	673032	£12.10	324	690626	£32.70	306
605915	£15.30	320	633032	£37.40	324	673436	£13.20	324	690627	£32.70	306
605916	£15.70	320	641011	£11.80	328	673840	£14.40	324	690629	£32.70	306
605917	£17.80	320	641213	£13.30	328	674244	£23.10	324	690630	£32.70	306
605919	£19.90	320	641314	£15.00	328	674648	£29.20	324	690632	£32.70	306
611214	£26.20	328	641617	£16.50	328	675052	£35.80	324	690634	£35.70	306
611618	£31.80	328	641922	£18.90	328	675456	£37.30	324	690636	£35.70	306
612022	£38.10	328	6507AF	£169.90	318	680608	£14.90	329	690638	£36.90	306
620607	£6.00	326	6507JAF	£497.70	318	680709	£19.60	329	690640	£36.90	306
620809	£6.40	326	6507JMM	£497.70	318	680810E	£24.30	329	690641	£43.90	306
621011	£7.80	326	650809	£25.40	327	681013	£22.80	329	690642	£43.90	306
6211MM	£164.90	327	6508RMM	£219.90	322	681214	£23.80	329	690644	£49.10	306
621213	£8.70	326	6509AF	£92.50	318	681416E	£30.50	329	690646	£49.10	306
621415	£9.30	326	651011	£27.90	327	681719	£27.80	329	690710	£27.50	306
621617	£10.30	326	651013	£29.90	327	681820E	£33.50	329	690711	£27.50	306
621819	£12.10	326	6510MM	£93.50	316	682122	£32.10	329	690712	£27.50	306
622022	£15.20	326	651213	£32.10	327	690510	£27.50	305	690713	£28.70	306
622123	£17.20	326	6512MM	£268.90	317	690511	£27.50	305	690714	£29.10	306
622427	£26.00	326	6512MM1	£111.90	316	690512	£27.50	305	690715	£29.10	306





		PAGE			PAGE			PAGE			PAGE
690716	£29.10	306	705-5	£8.40	438	902036	£58.50	331	910505	£6.20	363
690717	£29.10	306	705A	£20.00	438	902038	£66.60	331	910506	£6.20	363
690718	£30.30	306	705A-5	£9.60	438	902041	£73.90	331	910508	£6.20	363
690719	£30.30	306	710	£10.90	444	902046	£94.20	331	910510	£6.20	363
690813	£31.20	307	710-10	£7.80	444	902050	£128.90	331	910524	£37.60	295
690814	£31.20	307	710-100H	£122.90	444	902055	£138.90	331	910527	£37.60	295
690815	£31.20	307	710A	£6.00	441	902060	£202.90	331	910530	£37.60	295
690816	£31.20	307	710A-10	£4.60	442	902065	£214.90	331	910532	£37.60	295
690817	£32.20	307	710A-100	£37.60	442	902070	£263.90	331	910533	£37.60	295
690818	£32.30	307	710C	£6.00	442	902075	£272.90	331	910534	£37.60	295
690819	£32.30	307	710F	£6.00	442	902080	£525.90	331	910536	£38.00	295
690821	£33.70	307	710F-10	£6.20	442	902085	£630.90	331	910538	£39.60	295
690822	£33.70	307	710G	£11.80	442	902090	£689.90	331	910541	£42.50	295
690824	£33.70	307	710H	£3.20	442	902095	£848.90	331	910546	£54.90	295
690826	£35.50	307	710N	£20.40	443	902100	£977.90	331	910550	£58.90	295
690827	£35.50	307	710S	£24.90	441	903024	£35.60	331	910555	£73.10	295
690829	£35.50	307	710U-10	£5.00	443	903027	£39.50	331	910560	£95.10	295
690830	£35.50	307	711	£28.60	443	903030	£46.20	331	910565	£103.90	295
690832	£35.50	307	712	£31.40	443	903032	£50.30	331	910570	£120.50	295
690834	£38.70	307	800608	£9.10	319	903036	£58.40	331	910575	£161.10	295
690836	£39.80	307	800609	£9.30	319	903038	£66.50	331	910580	£174.10	295
690838	£41.40	307	800610	£9.50	319	903041	£72.70	331	910585	£189.90	295
690840	£44.50	307	800611	£9.70	319	903046	£90.20	331	910590	£199.50	295
690841	£47.40	307	800612	£9.90	319	903050	£95.70	331	910595	£233.50	295
690842	£47.40	307	800613	£10.20	319	903055	£110.80	331	910624	£88.10	295
690844	£54.80	307	800614	£11.00	319	903060	£126.40	331	910627	£88.50	295
690846	£54.80	307	800615	£11.70	319	903065	£154.30	331	910627R	£56.50	295
691406	£34.00	328	800616	£13.10	319	903070	£213.20	331	910628	£88.60	295
700-PRO5	£64.40	436	800617	£13.70	319	903075	£216.40	331	910630	£88.90	295
701	£39.70	437	800618	£15.30	319	903080	£452.70	331	910630R	£57.10	295
701N1	£45.40	437	800619	£15.90	319	903085	£519.90	331	910632	£89.30	295
702	£13.30	437-438	8512MM	£125.90	319	903090	£644.90	331	910632R	£57.50	295
703-10	£11.70	437	902024	£36.20	331	903095	£695.30	331	910633	£91.90	295
703A	£45.10	437	902027	£36.50	331	903100	£814.90	331	910633R	£58.60	295
704	£13.80	438	902030	£44.00	331	910086	£52.20	283	910636	£97.80	295
705	£14.60	438	902032	£45.90	331	910504	£6.20	363	910732	£118.30	296





INDEX

		PAGE			PAGE			PAGE			PAGE
9110	£12.20	464	920023N	£33.60	283	920242	£28.90	289	920525N	£12.90	286
9113	£387.50	249	920030AN	£30.30	283	920248	£31.90	289	920526N	£14.20	286
9117	£943.40	249	920030N	£31.40	283	9203N	£58.10	466-467	920527N	£15.20	286
9120	£13.40	464	920036AN	£15.30	283	9203N1	£32.40	467	920528N	£15.50	286
912041	£252.90	296	920036N	£15.30	283	920508N	£8.90	286	920529N	£15.90	286
912046	£252.90	296	920037AN	£24.80	283	920510AN	£7.40	287	920530N	£16.20	286
912050	£266.10	296	920037N	£25.60	283	920510N	£8.90	286	920532N	£17.40	286
912055	£294.70	296	920060-C	£11.00	283	920511AN	£7.40	287	920610AN	£13.50	289
912060	£323.40	296	920112	£9.10	287	920511N	£8.90	286	920610N	£16.20	288
912065	£339.50	296	920114	£9.10	287	920512AN	£7.40	287	920611AN	£13.50	289
912070	£393.90	296	920116	£9.10	287	920512N	£8.90	286	920611N	£16.20	288
912075	£427.90	296	920118	£9.10	287	920513AN	£7.40	287	920612AN	£13.50	289
912080	£486.90	296	920120	£9.60	287	920513N	£8.90	286	920612N	£16.20	288
912085	£512.90	296	920122	£10.10	287	920514AN	£7.40	287	920613AN	£13.60	289
912090	£799.90	296	920124	£10.30	287	920514N	£8.90	286	920613N	£16.20	288
912095	£1,249.00	296	920126	£10.30	287	920515AN	£7.70	287	920614AN	£13.90	289
9120HD	£36.90	465	920128	£10.60	287	920515N	£9.90	286	920614N	£16.20	288
9121	£64.80	248	920130	£11.40	287	920516AN	£8.00	287	920615AN	£14.10	289
912100	£1,612.00	296	920132	£12.40	287	920516N	£9.80	286	920615N	£16.40	288
912105	£1,684.00	296	920134	£13.20	287	920517AN	£8.00	287	920616AN	£14.10	289
912110	£1,859.00	296	920136	£14.80	287	920517N	£20.40	467	920616N	£16.40	288
912115	£1,969.00	296	920140	£15.80	287	920517N1	£9.80	286	920617AN	£14.10	289
912120	£2,029.00	296	920212	£15.00	289	920518AN	£8.20	287	920617N	£16.40	288
912125	£2,119.00	296	920214	£15.00	289	920518N	£9.80	286	920618AN	£14.60	289
912130	£2,144.00	296	920216	£15.00	289	920519AN	£9.80	287	920618N	£16.40	288
9123	£53.40	464	920218	£15.00	289	920519N	£20.40	467	920619AN	£14.70	289
9124	£63.10	479	920220	£15.60	289	920519N1	£9.80	286	920619N	£16.40	288
9126	£99.90	248	920222	£15.70	289	920520N	£9.80	286	920620N	£16.90	288
920001	£6.20	357	920224	£16.80	289	920521AN	£9.80	287	920621AN	£14.80	289
920002	£6.20	357	920226	£17.50	289	920521N	£20.80	467	920621N	£17.10	288
920003	£6.20	357	920228	£18.30	289	920521N1	£10.20	286	920622AN	£15.50	289
920020AN	£15.00	283	920230	£19.20	289	920522AN	£10.00	287	920622N	£17.30	288
920020N	£15.50	283	920232	£20.40	289	920522N	£10.80	286	920623N	£17.40	288
920021AN	£20.10	283	920234	£23.90	289	920523N	£11.70	286	920624AN	£15.70	289
920021N	£20.90	283	920236	£25.90	289	920524AN	£11.00	287	920624N	£18.90	288
920023AN	£32.50	283	920240	£26.80	289	920524N	£12.70	286	920627N	£22.70	288





		PAGE			PAGE			PAGE			PAGE
920628N	£24.40	288	921612	£21.00	290	940126	£19.90	292	940246	£38.30	294
920629N	£24.70	288	921614	£21.00	290	940128	£19.90	292	940248	£39.70	294
920630N	£25.00	288	921616	£21.00	290	940130	£20.20	292	940250	£42.90	294
920632N	£26.50	288	921618	£21.00	290	940132	£20.20	292	940252	£43.40	294
920635N	£29.60	288	921620	£21.90	290	940134	£21.20	292	940254	£47.00	294
920636N	£29.90	288	921622	£21.90	290	940136	£21.60	292	940256	£48.60	294
920710-C	£10.00	288	921624	£21.90	290	940138	£22.10	292	940258	£53.20	294
920713-C	£10.00	288	921814	£14.50	291	940140	£23.10	292	940260	£57.90	294
920714-C	£10.30	288	921816	£14.50	291	940142	£23.60	292	940519-C	£22.90	292
920716-C	£10.30	288	921817	£15.70	291	940144	£24.10	292	940521-C	£23.00	292
920717-C	£11.50	288	921818	£16.00	291	940146	£24.70	292	940522-C	£23.10	292
920721-C	£11.90	288	923090	£25.50	307	940148	£24.70	292	940523-C	£23.10	292
9207512	£97.20	248	923110	£25.50	307	940150	£26.80	292	940524-C	£23.30	292
921210TX-C	£21.20	291	923120	£25.50	307	940152	£27.70	292	940527-C	£23.90	292
921215TX-C	£20.70	291	923140	£25.50	307	940154	£28.90	293	940528-C	£23.90	292
921220TX-C	£20.70	291	923814	£16.00	291	940156	£30.00	293	940530-C	£25.90	292
921225TX-C	£20.70	291	923816	£16.00	291	940160	£36.30	293	940532-C	£26.50	292
921227TX-C	£20.70	291	923817	£17.30	291	940162	£39.70	293	940533-C	£27.30	292
921230TX-C	£20.70	291	923818	£17.60	291	940164	£39.70	293	940534-C	£30.20	292
921240TX-C	£20.70	291	9291719	£14.00	290	940166	£52.40	293	940536-C	£30.20	292
921245TX-C	£20.70	291	9292122	£15.80	290	940168	£53.90	293	940538-C	£32.80	292
921250TX-C	£20.70	291	930001	£6.20	353	940170	£57.50	293	940540-C	£36.30	292
921255TX-C	£20.70	291	930002	£6.20	353	940172	£59.10	293	940541-C	£36.80	292
921260TX-C	£20.70	291	930003	£6.20	353	940174	£63.70	293	940546-C	£43.60	292
921270TX-C	£20.70	291	930004	£6.20	353	940176	£66.10	293	940550-C	£48.00	292
921505-C	£18.90	290	9386	£55.50	247	940224	£34.30	294	940551-C	£65.20	292
921506-C	£18.90	290	940006	£6.20	351	940226	£35.40	294	940552-C	£65.20	292
921508-C	£18.90	290	940008	£6.20	351	940228	£35.40	294	940554-C	£69.60	292
921510-C	£19.80	290	940010	£6.60	351	940230	£35.60	294	940555-C	£76.10	292
921512-C	£19.80	290	940012	£6.80	351	940232	£35.70	294	940556-C	£82.60	292
921514-C	£19.80	290	940022-C	£54.70	283	940234	£35.70	294	940557-C	£82.60	292
921517-C	£20.90	290	940030-C	£82.80	283	940236	£35.90	294	940558-C	£82.60	292
921519-C	£20.90	290	940037-C	£39.90	283	940238	£36.20	294	940559-C	£87.00	292
921606	£20.10	290	940085-C	£33.90	283	940240	£36.20	294	940560-C	£87.00	292
921608	£20.10	290	940122	£19.60	292	940242	£36.80	294	940563-C	£108.70	292
921610	£20.10	290	940124	£19.60	292	940244	£37.90	294	940565-C	£108.70	292





INDEX

		PAGE			PAGE			PAGE			PAGE
940570-C	£132.60	292	970055	£6.80	359	ACC300CBH01	£24.20	367	AT096	£31.80	406
940619-C	£36.30	293	980020-C	£18.70	283	ACC35CBH01	£20.30	366	AT097	£31.80	406
940621-C	£36.40	293	980035-C	£12.50	283	ACC50CBH01	£18.20	365	AT135	£23.80	485
940622-C	£36.70	293	980036A-C	£13.20	283	ACC50MBH01	£7.10	365	AT135M	£37.10	485
940623-C	£36.90	293	980036-C	£15.60	283	ACC70MBH01	£9.40	365	AT180	£16.80	465
940624-C	£37.00	293	980060-C	£10.10	283	ACCSDA1412	£11.90	367	AT191	£101.80	466
940627-C	£37.00	293	980086	£9.10	283	ACCSDA1414	£6.70	367	AT192	£133.70	466
940630-C	£37.10	293	980508-C	£7.10	285	ACCSDA1438	£9.80	367	AT20512	£23.40	466
940632-C	£37.10	293	980510-C	£7.10	285	ACD01	£509.90	308	AT20516	£36.60	466
940633-C	£37.50	293	980511-C	£7.10	285	ALU1000-4	£31.80	213	AT20520	£44.00	466
940634-C	£38.10	293	980512-C	£7.10	285	ALU12	£7.70	213	AT20524	£57.50	466
940636-C	£40.80	293	980513-C	£7.20	285	ALU14	£7.70	213	AT350	£34.70	466
940638-C	£43.70	293	980514-C	£7.60	285	ALU34	£8.50	213	AT355	£24.40	466
940641-C	£57.00	293	980515-C	£7.60	285	ALU38	£7.70	213	AT360	£26.70	466
940646-C	£70.30	293	980516-C	£7.70	285	ALU430	£10.20	213	AT365	£25.10	466
940650-C	£74.40	293	980517-C	£7.70	285	ARB01	£13.60	506	AT370	£20.90	466
940652-C	£87.00	293	980519-C	£8.20	285	ARB02	£14.60	507	AT375	£26.70	466
940654-C	£89.10	293	980608-C	£9.60	285	ARB03	£13.90	507	AT380	£27.70	466
940655-C	£93.50	293	980610-C	£9.90	285	ARBS10	£435.90	504	AT415	£48.20	468
940656-C	£97.80	293	980611-C	£9.90	285	ARD10	£198.00	502	AT605	£61.20	482
940658-C	£100.00	293	980612-C	£10.10	285	ARD13	£293.00	502	BC408	£62.60	402
940660-C	£108.70	293	980613-C	£10.10	285	AREP25	£166.90	506	BC408T	£64.40	402
940665-C	£121.70	293	980614-C	£10.40	285	ARG01	£148.90	504	BC414	£69.00	403
940732-C	£101.90	294	980616-C	£11.20	285	ARN12	£155.00	505	BC418	£83.00	403
941519-C	£67.60	294	980617-C	£11.20	285	ARRG80	£325.00	505	BC424	£106.00	403
941522-C	£68.20	294	980619-C	£12.00	285	ARS01	£399.00	503	BC430	£147.00	403
941524-C	£68.60	294	981504-C	£13.40	286	ARS02	£325.00	503	BC436	£181.00	403
960506-C	£6.00	284	981505-C	£13.40	286	ARWC12	£409.00	501	BDIS-TYR	£87.90	494
960507-C	£6.00	284	981506-C	£13.40	286	ARWC38	£357.00	500	BWT406	£37.20	330,416
960508-C	£6.00	284	981507-C	£13.40	286	ARWMIIS	£1,688.00	501	CALD150	£78.10	450
960510-C	£6.20	284	981508-C	£13.40	286	ARWM38	£362.00	500	CALV150	£46.20	450
960513-C	£6.40	284	981510-C	£14.20	286	AT040	£50.30	465	CC150F	£14.80	493
970030	£6.30	359	981512-C	£14.20	286	AT080	£16.10	462	CC200F	£23.00	493
970040	£6.30	359	9850	£12.90	480	AT085	£17.90	462	CC240F	£27.10	493
970045	£6.30	359	AB200	£10.70	454	AT090	£23.10	462	CC250F	£27.90	493
970050	£6.30	359	ABS-TOP	£33.90	214	AT094	£33.40	406	CMD16	£31.80	489





		PAGE			PAGE			PAGE			PAGE
CMD20	£46.90	489	DBX010	£5.50	439	DIS-SP05	£1,189.00	474	FLTR10	£17.00	447
CMD30A	£68.30	489	DBX015	£6.20	439	DM550	£53.00	482	FTF32406005	£7.70	350
CMD40	£67.90	489	DBX020	£6.80	439	DP0810	£15.00	465	FTF4055	£9.90	342
CMD40A	£76.90	489	DBX025	£7.60	439	DP0812	£15.00	465	GR25002010	£12.80	354
CMD80	£74.20	489	DBX030	£13.40	439	DP1012	£15.00	465	GR25002100	£79.90	354
CMF16	£42.90	490	DBX033	£15.90	439	DP1112	£15.00	465	GRP3000201	£3.30	354
CMF16T	£56.30	489	DBX035	£15.90	439	DP1314	£15.00	465	GRP3000205	£10.50	354
CMF20	£60.70	490	DBX040	£17.20	439	DP1716	£15.00	465	GRP5000201	£3.40	354
CMF20T	£67.60	489	DBX042	£21.70	439	EVA-453660	£18.30	215	HBH0303	£10.80	342
CMF25	£68.90	490	DBX045	£21.70	439	EVA-453946	£23.80	215	HBH0404	£10.80	342
CMF25T	£81.40	489	DBX050	£25.60	439	FC01	£77.10	468	HBH0505	£10.80	342
CMF30	£84.40	490	DBX055	£35.30	439	FG13100	£6.90	451	HBH0606	£10.80	342
CMF30T	£98.70	489	DBX060	£39.40	439	FG20100	£9.10	451	HEX2500203	£5.60	361
CMF35	£84.30	490	DBX065	£44.30	439	FG20200	£23.30	451	HEX2500303	£5.60	361
CMF35T	£94.90	489	DBX068	£52.40	439	FL2506A03	£5.30	350	HEX2500403	£5.60	361
CMFQ25	£138.90	490	DBX070	£52.40	439	FL2506B03	£5.30	350	HEX2500503	£5.60	361
CMFQ40	£177.90	490	DBX075	£61.30	439	FL2508A03	£5.30	350	HEX2500603	£5.60	361
CMQ150	£39.60	489	DBX080	£39.70	439	FL2508B03	£5.30	350	HEX2500803	£7.00	361
CMQ300	£44.70	489	DBX085	£42.80	439	FL2510A03	£5.30	350	HEX5000403	£7.00	361
CMQ450	£50.90	489	DBX090	£50.30	439	FL2512A03	£5.30	350	HEX5000503	£7.00	361
CMQ600	£57.80	489	DBX095	£55.40	439	FL2516A03	£7.00	350	HEX5000603	£7.00	361
CMQL150	£47.90	489	DBX100	£64.90	439	FL5006A03	£7.00	350	HEX5000803	£10.40	361
CMQL300	£54.20	489	DBX105	£70.60	439	FL5008A03	£7.00	350	HEX8900401	£7.40	362
CMQL450	£62.50	489	DBX110	£81.90	439	FL5008B03	£7.00	350	HEXP3000301	£3.20	362
CP04	£9.60	493	DBX115	£89.40	439	FL5010A03	£7.00	350	HEXP3000305	£10.70	362
CP05	£9.60	493	DBX120	£102.60	439	FL5012A03	£7.00	350	HEXP3000401	£3.20	362
CP08	£10.80	493	DBX125	£111.90	439	FL7006A02	£7.00	350	HEXP3000405	£10.70	362
CP50	£32.90	480	DBX130	£120.20	439	FL7008A02	£7.00	350	HEXP3000501	£3.20	362
CP52	£104.90	480	DET01	£20.30	479	FL7008B02	£7.00	350	HEXP3000505	£10.70	362
CP53	£33.90	481	DET01RK	£14.50	479	FL7010A02	£7.00	350	HEXP3000601	£3.20	362
CP55	£43.00	481	DET02	£12.50	479	FL8905A01	£7.30	351	HEXP3000605	£10.70	362
CP58	£81.10	481	DGMM	£129.00	451	FL8908A01	£7.30	351	HEXP5000301	£3.80	362
CP60	£53.20	481	DHW1300	£17.60	491	FLFT10	£16.70	447	HEXP5000401	£3.80	362
CTG01	£56.70	482	DHW1417	£26.00	491	FLHF10	£16.70	447	HEXP5000501	£3.80	362
DB028	£104.90	438	DHW1922	£29.00	491	FLHR10	£17.50	447	HEXP5000601	£3.80	362
DB034	£210.90	439	DIE-HNDL	£16.40	441	FLRD10	£16.30	447	HMBH01	£42.60	469





INDEX

		PAGE			PAGE			PAGE			PAGE
HMBH02	£43.00	469	HRLN65N	£794.60	484	M120011-C	£37.20	257	M120134-C	£13.00	275
HMBH03	£50.90	469	HRLR01	£274.40	484	M120012-C	£66.20	257	M120136-C	£14.20	275
HMBP12	£23.70	491	HRLT01	£311.00	484	M120020-C	£9.50	258	M120138-C	£14.60	275
HMBP16	£28.40	491	IBA14	£5.60	367	M120020W-C	£15.10	258	M120140-C	£16.00	275
HMBP24	£39.40	491	ID506	£47.10	372	M120021-C	£12.20	258	M1205086-C	£7.20	274
HMBP32	£42.10	491	ID506BIT	£8.30	368	M120021W-C	£19.20	258	M120508-C	£7.20	274
HMCH13A	£32.80	491	ID515	£44.90	372	M120022-C	£18.90	258	M120509-C	£7.20	274
HMCH16A	£33.50	491	ID515BIT	£19.20	368	M120022W-C	£24.20	258	M1205106-C	£7.20	274
HMCH16M	£42.20	492	IDSE7	£25.00	372	M120023-C	£11.50	258	M120510-C	£7.20	274
HMCHM16	£69.90	492	KP01	£29.30	495	M120024-C	£39.90	258	M1205116-C	£7.40	274
HMDH35	£31.80	469,492	KP02	£74.10	495	M120030-C	£23.90	258	M120511-C	£7.40	274
HMDH45	£45.90	469,492	M1100	£219.00	255	M120036-C	£9.40	259	M1205126-C	£7.40	274
HMDH50PU	£71.30	469,492	M110010	£172.90	255	M120037-C	£19.00	259	M120512-C	£7.40	274
HMDH55	£51.30	469,492	M110020	£61.90	255	M120037M	£32.10	260	M1205136-C	£7.40	274
HMDH60PU	£76.40	469,492	M110030	£44.70	259	M120040-C	£9.60	463	M120513-C	£7.40	274
HMDH65	£69.80	469,492	M110040	£70.50	258	M120042-C	£10.40	463	M1205146-C	£7.40	274
HMDH70PU	£97.80	469,492	M110050	£91.60	258	M120046-C	£11.90	463	M120514-C	£7.40	274
HMEG300	£22.80	491	M110070	£196.90	257	M120050-C	£20.20	260	M1205156-C	£8.10	274
HMEG500	£27.60	491	M110070RK	£62.20	257	M120060-C	£10.00	260	M120515-C	£8.10	274
HMEG800	£35.40	491	M1100-72	£326.90	254	M120061-C	£12.90	260	M1205166-C	£8.30	274
HMS1250	£61.00	491	M1100-72RK	£99.30	255	M120062-C	£14.90	260	M120516-C	£8.30	274
HMSF	£41.80	492	M1100RK	£78.90	255	M120063-C	£14.90	260	M1205176-C	£8.50	274
HN02	£174.40	484	M110536	£38.30	282	M120080-C	£24.00	259	M120517-C	£8.50	274
HP101	£33.10	330	M110541	£42.30	282	M120112-C	£7.50	275	M1205186-C	£8.60	274
HP102	£50.30	330	M110546	£50.90	282	M120114-C	£7.50	275	M120518-C	£8.60	274
HP103	£61.50	330	M110550	£58.90	282	M120116-C	£7.50	275	M1205196-C	£8.80	274
HP2014	£43.90	330	M110555	£66.50	282	M120118-C	£7.50	275	M120519-C	£8.80	274
HP2015	£43.90	330	M110558	£67.90	282	M120119-C	£8.20	275	M1205206-C	£9.50	274
HP2025	£58.70	330	M110560	£73.90	282	M120120-C	£8.60	275	M120520-C	£9.50	274
HP2026	£59.30	330	M110565	£92.90	282	M120122-C	£8.60	275	M1205216-C	£9.50	274
HP2036	£67.90	330	M110570	£102.90	282	M120124-C	£8.90	275	M120521-C	£9.50	274
HP2038	£67.90	330	M110575	£113.90	282	M120125-C	£9.20	275	M1205226-C	£10.00	274
HR01	£87.70	483	M110580	£132.90	282	M120126-C	£9.40	275	M120522-C	£10.00	274
HR12	£74.10	483	M115MM	£989.00	239	M120128-C	£9.40	275	M1205236-C	£10.10	274
HR30R	£88.20	483	M120010-C	£38.70	257	M120130-C	£9.90	275	M120523-C	£10.10	274
HR360R	£124.50	483	M120010RK	£16.50	257	M120132-C	£11.00	275	M1205246-C	£11.30	274





		PAGE			PAGE			PAGE			PAGE
M120524-C	£11.30	274	M120621-C	£16.30	276	M121227-C	£10.20	279	M122250T-C	£17.20	278
M1205256-C	£12.30	274	M120622-C	£16.30	276	M121227T-C	£10.20	278	M122255T-C	£19.50	278
M120525-C	£12.30	274	M1206246-C	£16.90	275	M121230-C	£10.20	279	M122260T-C	£21.30	278
M1205266-C	£12.70	274	M120624-C	£16.90	276	M121230T-C	£10.20	278	M122270T-C	£21.60	278
M120526-C	£12.70	274	M120627-C	£21.90	276	M121240-C	£10.20	279	M122505-C	£10.60	277
M1205276-C	£13.10	274	M120630-C	£24.70	276	M121240T-C	£10.20	278	M122506A-C	£12.70	277
M120527-C	£13.10	274	M120632-C	£25.00	276	M121245-C	£11.10	279	M122506-C	£10.60	277
M1205286-C	£14.00	274	M120636-C	£28.90	276	M121245T-C	£11.10	278	M122507-C	£10.60	277
M120528-C	£14.00	274	M1207	£78.10	237	M121250-C	£11.10	279	M122508A-C	£12.70	277
M1205296-C	£14.70	274	M120710-C	£9.90	279	M121250T-C	£11.10	278	M122508-C	£10.60	277
M120529-C	£14.70	274	M120711-C	£9.90	279	M121255-C	£12.30	279	M122510-C	£12.90	277
M1205306-C	£14.80	274	M120712-C	£9.90	279	M121255T-C	£12.30	278	M122510L-C	£15.50	277
M120530-C	£14.80	274	M120714-C	£9.90	279	M121260-C	£13.30	279	M122512-C	£13.90	277
M1205326-C	£16.60	274	M120716-C	£9.90	279	M121260T-C	£13.30	278	M122514-C	£15.60	277
M120532-C	£16.60	274	M120718-C	£10.90	279	M1212N1	£112.10	234	M122517-C	£19.20	277
M1205336-C	£18.00	274	M120720-C	£11.30	279	M1213TPX	£65.90	239	M122704-C	£14.90	280
M1205346-C	£18.20	274	M120722-C	£11.30	279	M1213TX	£66.20	239	M122705-C	£14.90	280
M120534-C	£18.20	274	M120724-C	£11.60	279	M121505-C	£10.40	276	M122706-C	£14.90	280
M120610-C	£14.90	276	M1208-6	£81.20	237	M121506-C	£10.40	276	M122708-C	£14.90	280
M120611-C	£14.90	276	M1209AF	£68.30	238	M121507-C	£10.40	276	M122709-C	£17.00	280
M120612-C	£14.90	276	M1210	£63.40	238	M121508-C	£10.40	276	M122710-C	£18.00	280
M1206136-C	£14.90	275	M1211	£55.90	238	M121509-C	£10.40	276	M122711-C	£20.60	280
M120613-C	£14.90	276	M121106-C	£10.90	277	M121510-C	£11.20	276	M122712-C	£23.50	280
M1206146-C	£15.40	275	M121107-C	£10.90	277	M121512-C	£12.20	276	M122713-C	£25.20	280
M120614-C	£15.40	276	M121108-C	£10.90	277	M121514-C	£14.50	276	M122805-C	£15.00	280
M1206156-C	£15.40	275	M121109-C	£11.00	277	M121516-C	£15.90	276	M122806-C	£15.00	280
M120615-C	£15.40	276	M121110-C	£11.00	277	M121517-C	£17.40	276	M122808-C	£15.00	280
M1206166-C	£15.40	275	M121112-C	£11.40	277	M121519-C	£18.60	276	M122809-C	£15.90	280
M120616-C	£15.40	276	M121116-C	£12.40	277	M1215AF	£86.90	237	M122810-C	£18.40	280
M1206176-C	£15.80	275	M121118-C	£15.20	277	M1215MM	£86.20	237	M122812-C	£20.90	280
M120617-C	£15.80	276	M121120-C	£17.90	277	M122220T-C	£16.30	278	M122814-C	£22.50	280
M1206186-C	£15.80	275	M1212	£64.90	238	M122225T-C	£16.30	278	M122816-C	£24.90	280
M120618-C	£15.80	276	M121220-C	£10.20	279	M122227T-C	£16.30	278	M140012-C	£44.80	257
M1206196-C	£15.80	275	M121220T-C	£10.20	278	M122230T-C	£16.30	278	M140012RK	£11.20	257
M120619-C	£15.80	276	M121225-C	£10.20	279	M122240T-C	£16.30	278	M140015-C	£16.70	256
M120620-C	£15.80	276	M121225T-C	£10.20	278	M122245T-C	£17.20	278	M140020-C	£5.60	258





INDEX

		PAGE			PAGE			PAGE			PAGE
M140021-C	£6.50	258	M140206-C	£7.90	264	M14051212-C	£5.10	261	M141225T-C	£5.00	265
M140022-C	£7.20	258	M14020712-C	£7.90	264	M140512-C	£5.10	261	M141227T-C	£5.00	265
M140023-C	£6.40	258	M140207-C	£7.90	264	M14051312-C	£5.20	261	M141230T-C	£5.00	265
M140024-C	£16.50	258	M14020812-C	£7.90	264	M140513-C	£5.20	261	M141240T-C	£5.10	265
M140025M	£3.90	364	M140208-C	£7.90	264	M140604-C	£7.50	263	M141300-C	£5.10	264
M140030-C	£16.70	258	M14020912-C	£7.90	264	M1406055-C	£7.50	263	M141301-C	£5.10	264
M140036-C	£5.60	259	M140209-C	£7.90	264	M140605-C	£7.50	263	M141302-C	£5.10	264
M140036M	£16.20	260	M14021012-C	£7.90	264	M14060612-C	£7.50	263	M141303-C	£5.10	264
M140037	£6.10	259	M140210-C	£7.90	264	M140606-C	£7.50	263	M1413N1	£65.50	222
M140038-C	£15.60	258	M14021112-C	£7.90	264	M14060712-C	£7.50	263	M141404-C	£5.10	264
M140039	£5.50	259	M140211-C	£7.90	264	M140607-C	£7.50	263	M1414055-C	£5.10	264
M140050-C	£8.00	260	M14021212-C	£7.90	264	M14060812-C	£7.50	263	M141407-C	£5.10	264
M140060-C	£6.40	260	M140212-C	£7.90	264	M140608-C	£7.50	263	M141503-C	£7.10	265
M140060M	£9.10	259	M14021412-C	£7.90	264	M14060912-C	£7.50	263	M141504-C	£7.10	265
M140070	£34.40	440	M140214-C	£7.90	264	M140609-C	£7.50	263	M1415055-C	£7.10	265
M140071	£19.10	440	M14021612-C	£8.00	264	M14061012-C	£7.50	263	M141505-C	£7.10	265
M140072	£24.10	440	M140216-C	£8.10	264	M140610-C	£7.50	263	M141506-C	£7.10	265
M14010612-C	£5.20	262	M14050412-C	£5.00	261	M14061112-C	£7.50	263	M141507-C	£7.20	265
M140106-C	£5.20	262	M1405045-C	£5.00	261	M140611-C	£7.50	263	M141508-C	£7.20	265
M14010712-C	£5.20	262	M140504-C	£5.00	261	M14061212-C	£7.50	263	M141510-C	£7.70	265
M140107-C	£5.20	262	M14050512-C	£5.00	261	M140612-C	£7.50	263	M141512-C	£8.50	265
M14010812-C	£5.20	262	M140505512-C	£5.00	261	M14061312-C	£7.70	263	M141601-C	£5.00	265
M140108-C	£5.20	262	M1405055-C	£5.00	261	M140613-C	£8.00	263	M141602-C	£5.00	265
M14010912-C	£5.20	262	M140505-C	£5.00	261	M1407	£35.50	226	M141603-C	£5.00	265
M140109-C	£5.20	262	M14050612-C	£5.00	261	M140704-C	£5.30	265	M340020-C	£22.10	258
M14011012-C	£5.20	262	M140506-C	£5.00	261	M140705-C	£5.30	265	M340020S-C	£35.50	258
M140110-C	£5.20	262	M14050712-C	£5.00	261	M140706-C	£5.30	265	M340021-C	£32.50	258
M14011112-C	£5.30	262	M140507-C	£5.00	261	M140707-C	£5.30	265	M340021S-C	£40.80	258
M140111-C	£5.30	262	M14050812-C	£5.00	261	M140708-C	£5.30	265	M340022-C	£46.10	258
M14011212-C	£5.30	262	M140508-C	£5.00	261	M1408TX	£30.50	227	M340022S-C	£60.10	258
M140112-C	£5.30	262	M14050912-C	£5.00	261	M1409HN	£43.50	227	M340030-C	£63.60	258
M14011412-C	£5.40	262	M140509-C	£5.00	261	M1410T5	£32.50	368	M340050-C	£54.40	260
M140114-C	£5.40	262	M14051012-C	£5.00	261	M1412	£33.90	226	M340050S-C	£69.90	260
M14011612-C	£5.40	262	M140510-C	£5.00	261	M141210T-C	£5.00	265	M340070-C	£90.40	257
M140116-C	£5.40	262	M14051112-C	£5.00	261	M141215T-C	£5.00	265	M340070RK	£24.40	257
M14020612-C	£7.90	264	M140511-C	£5.00	261	M141220T-C	£5.00	265	M340070S-C	£99.90	257





		PAGE			PAGE			PAGE			PAGE
M340070SRK	£32.80	257	M3405416-C	£26.50	281	M38011212-C	£5.80	267	M380509-C	£5.70	266
M3400-72	£195.90	254	M3405466-C	£30.60	281	M380112-C	£5.80	267	M38051012-C	£5.70	266
M340072E	£267.90	254	M3405506-C	£35.10	281	M38011412-C	£5.80	267	M380510-C	£5.70	266
M3400-72RK	£85.60	255	M341514-C	£32.30	282	M380114-C	£5.90	267	M38051112-C	£5.70	266
M340085-C	£28.70	259	M341517-C	£32.30	282	M38011612-C	£5.90	267	M380511-C	£5.70	266
M340085M	£37.50	260	M341519-C	£32.30	282	M380116-C	£5.90	267	M38051212-C	£5.70	266
M340086-C	£25.00	259	M341522-C	£32.30	282	M38011812-C	£5.90	267	M380512-C	£5.70	266
M340124-C	£16.40	281	M380010A-C	£32.90	257	M380118-C	£5.90	267	M38051312-C	£5.70	266
M340128-C	£16.40	281	M380011-C	£25.20	257	M38012012-C	£5.90	267	M380513-C	£5.70	266
M340130-C	£16.40	281	M380012-C	£46.80	257	M380120-C	£5.90	267	M38051412-C	£5.80	266
M340132-C	£16.40	281	M380012RK	£12.10	257	M38012212-C	£6.80	267	M380514-C	£5.80	266
M340134-C	£16.60	281	M380015-C	£24.50	256	M380122-C	£6.90	267	M38051512-C	£5.80	266
M340136-C	£17.80	281	M380020-C	£7.40	258	M38012412-C	£7.10	267	M380515-C	£5.80	266
M340138-C	£18.10	281	M380020W-C	£12.20	258	M380124-C	£7.30	267	M38051612-C	£6.70	266
M340140-C	£18.80	281	M380021-C	£9.30	258	M380126-C	£7.40	267	M380516-C	£6.80	266
M340142-C	£19.10	281	M380021W-C	£15.00	258	M380128-C	£7.60	267	M38051712-C	£6.90	266
M340144-C	£24.20	281	M380022-C	£13.20	258	M38021212-C	£9.20	269	M380517-C	£6.90	266
M340146-C	£25.20	281	M380022W-C	£19.10	258	M380212-C	£9.20	269	M38051812-C	£6.90	266
M340148-C	£25.50	281	M380023-C	£9.20	258	M38021412-C	£9.20	269	M380518-C	£7.00	266
M340152-C	£28.10	281	M380024-C	£33.10	258	M380214-C	£9.20	269	M38051912-C	£7.00	266
M340156-C	£31.80	281	M380030-C	£19.70	258	M38021612-C	£9.20	269	M380519-C	£7.10	266
M340158-C	£32.90	281	M380035A-C	£9.70	259	M380216-C	£9.20	269	M380520-C	£7.60	266
M340160-C	£34.40	281	M380035-C	£9.70	259	M38021812-C	£9.40	269	M380521-C	£8.10	266
M340164-C	£37.50	281	M380036-C	£10.20	259	M380218-C	£9.40	269	M38052212-C	£8.10	266
M3405196-C	£15.50	281	M380036M	£24.40	260	M38022012-C	£9.40	269	M380522-C	£8.10	266
M3405216-C	£15.50	281	M380037	£10.00	259	M380220-C	£9.50	269	M3806	£66.90	233
M3405226-C	£15.50	281	M380039-C	£9.30	463	M38022212-C	£10.80	269	M38060712-C	£9.60	268
M3405246-C	£15.50	281	M380040-C	£8.00	463	M380222-C	£10.80	269	M380607-C	£9.60	268
M3405266-C	£15.50	281	M380041-C	£20.10	463	M38022412-C	£12.20	269	M38060812-C	£9.60	268
M3405276-C	£16.40	281	M380042-C	£8.80	463	M380224-C	£12.20	269	M380608-C	£9.60	268
M3405306-C	£16.90	281	M380046-C	£9.40	463	M380226-C	£13.40	269	M38060912-C	£9.60	268
M3405326-C	£17.90	281	M380047-C	£20.00	463	M380228-C	£14.10	269	M380609-C	£9.60	268
M3405336-C	£19.20	281	M380050-C	£19.00	260	M380507-C	£5.40	266	M38061012-C	£9.60	268
M3405346-C	£20.40	281	M380060-C	£7.40	260	M38050812-C	£5.70	266	M380610-C	£9.60	268
M3405366-C	£21.60	281	M380061-C	£9.40	260	M380508-C	£5.70	266	M38061112-C	£9.60	268
M3405386-C	£24.00	281	M380110-C	£5.80	267	M38050912-C	£5.70	266	M380611-C	£9.60	268





INDEX

		PAGE			PAGE			PAGE			PAGE
M38061212-C	£9.70	268	M381106-C	£10.00	272	M381506BL-C	£11.30	271	M386512-C	£12.80	307
M380612-C	£9.70	268	M381107-C	£10.00	272	M381506-C	£9.90	270	M386513-C	£12.80	307
M38061312-C	£9.70	268	M381108-C	£10.00	272	M381507BL-C	£12.30	271	M386514-C	£12.90	307
M380613-C	£9.70	268	M381110-C	£10.20	272	M381507-C	£10.00	270	M386515-C	£13.20	307
M38061412-C	£9.80	268	M381112-C	£10.20	272	M381508BL-C	£14.40	271	M386516-C	£15.20	307
M380614-C	£9.80	268	M3812	£61.70	231	M381508-C	£10.00	270	M386517-C	£15.20	307
M38061512-C	£9.80	268	M381210-C	£10.10	273	M381510BL-C	£14.40	271	M386518-C	£16.10	307
M380615-C	£9.80	268	M381210T-C	£10.10	272	M381510-C	£10.00	270	M386519-C	£17.00	307
M38061612-C	£11.60	268	M381215-C	£10.10	273	M381512BL-C	£17.10	271	MB410	£31.30	406
M380616-C	£11.60	268	M381215T-C	£10.10	272	M381512-C	£11.10	270	MB412	£45.10	406
M38061712-C	£11.70	268	M381220-C	£10.10	273	M3816	£66.20	231	MB416	£71.20	406
M380617-C	£11.70	268	M381220T-C	£10.10	272	M382210T-C	£12.30	273	MB441-5	£22.40	400
M38061812-C	£11.70	268	M381225-C	£10.10	273	M382215T-C	£12.30	273	MB441-5T	£25.30	400
M380618-C	£11.70	268	M381225T-C	£10.10	272	M382220T-C	£12.30	273	MB441-6	£25.60	400
M38061912-C	£12.60	268	M381227-C	£10.10	273	M382225T-C	£12.30	273	MB441-6T	£28.60	400
M380619-C	£12.70	268	M381227T-C	£10.10	272	M382227T-C	£12.30	273	MB442-5	£26.80	400
M38062012-C	£12.70	268	M381230-C	£10.10	273	M382230T-C	£12.30	273	MB442-6	£26.20	400
M380620-C	£12.80	268	M381230T-C	£10.10	272	M382240T-C	£12.30	273	MB442-6T	£28.60	400
M38062112-C	£13.10	268	M381240-C	£10.10	273	M382245T-C	£13.40	273	MB442-7	£30.70	400
M380621-C	£13.10	268	M381240T-C	£10.10	272	M382250T-C	£13.40	273	MB442-7S	£39.40	400
M38062212-C	£13.20	268	M381245-C	£10.20	273	M382503-C	£11.80	271	MB442-8	£31.90	400
M380622-C	£13.20	268	M381245T-C	£10.20	272	M382504-C	£11.80	271	MB442-8T	£35.00	400
M3807	£42.40	231	M381250-C	£10.20	273	M3825055-C	£11.80	271	MB442B-8T	£35.40	400
M380710-C	£7.00	273	M381250T-C	£10.20	272	M382505-C	£11.80	271	MB444-10	£53.00	401
M380712-C	£7.00	273	M3812N1	£75.60	227	M382506-C	£11.80	271	MB444-6	£32.10	401
M380714-C	£7.00	273	M3813TPX	£60.90	232	M382507-C	£12.00	271	MB444-8	£37.00	401
M380716-C	£7.00	273	M3813TX	£60.90	232	M382508-C	£12.30	271	MB444-8T	£38.00	401
M380718-C	£7.10	273	M3814	£41.90	233	M382510-C	£13.70	271	MB445-10	£58.00	401
M3808MM	£101.90	233	M381503BL-C	£11.30	271	M382512-C	£16.00	271	MB448-8	£43.90	403
M3809	£93.90	231	M381503-C	£9.90	270	M382704-C	£10.50	272	MB449-10	£38.60	403
M3809HBN	£92.90	232	M381504BL-C	£11.30	271	M382705-C	£10.50	272	MB449-11	£39.80	403
M3809TX	£94.10	233	M381504-C	£9.90	270	M382706-C	£10.50	272	MB449-9	£35.70	403
M3811	£61.50	232	M3815055BL-C	£11.30	271	M382708-C	£13.10	272	MB451-7	£26.60	404
M381103-C	£10.00	272	M3815055-C	£9.90	270	M382709-C	£13.10	272	MB451-8	£31.10	404
M381104-C	£10.00	272	M381505BL-C	£11.30	271	M386510-C	£12.50	307	MB452-6	£29.80	404
M381105-C	£10.00	272	M381505-C	£9.90	270	M386511-C	£12.50	307	MB452-6T	£31.80	404





		PAGE			PAGE			PAGE			PAGE
MB452-7	£31.60	404	MBE470-7	£29.80	410	MD620TPN	£9.30	341	MD917N	£7.00	339
MB452-7T	£33.20	404	MBE470-9	£46.20	410	MD625TPN	£11.50	341	MD917N2	£7.80	339
MB452-8	£34.80	404	MBE471-5	£28.20	410	MD627TPN	£11.50	341	MD920N	£6.50	339
MB452-8T	£37.10	404	MBE471-7	£29.80	410	MD630TPN	£11.50	341	MD920N1	£7.00	339
MB461-5	£25.50	404	MBE471-9	£46.20	410	MD640TPN	£11.50	341	MD920TN	£9.20	341
MB461-6	£26.20	404	MBE472-5	£28.20	410	MD7020HBN	£6.30	341	MD922N	£8.90	339
MB461-6T	£28.00	405	MBE472-7	£29.80	410	MD7020HN	£6.10	341	MD923N	£9.30	339
MB461-8	£30.00	404	MBE472-9	£46.20	410	MD7025HBN	£6.30	341	MD925TN	£11.20	341
MB461-8T	£32.40	405	MBE473-5	£28.20	411	MD7030HBN	£7.10	341	MD927TN	£11.20	341
MB463-5	£27.60	405	MBE473-7	£29.80	411	MD7030HN	£6.30	341	MD928N	£7.90	339
MB463-6	£28.50	405	MBE473-9	£46.20	411	MD7040HBN	£7.80	341	MD928N1	£10.70	339
MB463-8	£30.50	405	MBH114	£12.90	366	MD7050HBN	£9.30	341	MD928N2	£11.20	339
MB463-8T	£32.50	405	MBM441	£26.20	408	MD7060HBN	£12.10	341	MD928N3	£12.00	339
MB464-6	£25.70	405	MBM449	£26.20	408	MD7080HBN	£16.40	341	MD928N4	£10.20	339
MB464-6T	£25.90	406	MBM461	£26.20	409	MD801N	£10.30	342	MD928N5	£11.00	339
MB465-6	£28.90	406	MBM464	£26.20	409	MD802N	£10.40	342	MD928N6	£12.00	339
MB470-20	£194.90	411	MBM467	£29.80	409	MD803N	£10.40	342	MD930N	£18.10	339
MB472-20	£194.90	411	MBM468	£30.20	409	MD901	£13.30	342	MD930TN	£11.30	341
MB481-10	£33.50	407	MBM469	£30.20	410	MD9053N	£236.90	344	MD931N	£10.30	339
MB481-10Q	£50.50	407	MBV441-6	£32.90	424	MD906N	£54.90	345	MD932N	£10.90	339
MB481-10T	£36.20	407	MBV442-8	£44.80	424	MD906N3	£54.90	345	MD932N1	£11.90	339
MB481-7	£28.80	407	MBV444-8	£43.00	425	MD906TN	£7.00	341	MD934N	£15.10	339
MB482-10Q	£53.10	407	MBV451-7	£42.00	424	MD907FL	£26.70	373	MD935N	£18.40	339
MB482-10TQ	£52.80	408	MBV451-8	£45.80	424	MD907TN	£7.00	341	MD940N	£6.40	340
MB482-12Q	£65.20	407	MBV461-8	£40.80	424	MD908TN	£7.00	341	MD940N1	£8.90	340
MB482-7Q	£46.10	407	MBV463-8	£36.40	424	MD909TN	£7.00	341	MD940TN	£11.30	341
MB482-7TQ	£40.50	408	MBV482-10Q	£50.90	425	MD910N	£99.90	344	MD945TN	£15.60	341
MB483-10	£71.30	332	MBV499-7	£37.50	425	MD910TN	£9.10	341	MD947N	£8.00	340
MB483-7	£57.00	332	MD193	£13.20	373	MD911N	£101.90	345	MD947N1	£8.40	340
MB489-7	£34.50	403	MD216	£13.20	373	MD912N	£105.90	346	MD948N	£8.00	340
MB489-8	£41.50	403	MD503N	£16.90	462	MD914N	£5.80	339	MD948N1	£10.70	340
MB499-7T	£30.90	482	MD503NA	£14.20	462	MD915N	£5.80	339	MD948N2	£12.40	340
MB541-5	£34.10	401	MD503ND	£14.30	462	MD915TN	£9.20	341	MD948N4	£10.50	340
MB541-6	£36.10	401	MD514L	£25.40	256	MD916N	£6.50	339	MD948N5	£11.80	340
MB541-7	£44.90	401	MD610TPN	£9.30	341	MD916N1	£7.00	339	MD948N6	£16.80	340
MBE470-5	£28.20	410	MD615TPN	£9.30	341	MD916N2	£7.50	339	MD948N8	£13.90	340





INDEX

		PAGE			PAGE			PAGE			PAGE
MD949N	£14.60	340	MDM806	£7.70	336	MDR06	£11.30	461	MDV828N	£14.10	420
MD950N	£18.10	340	MDM806T	£7.50	338	MDR08	£14.60	461	MDV840N	£8.00	420
MD952N	£11.30	340	MDM807	£7.70	336	MDR908	£25.10	375	MDV842N	£10.30	420
MD952N1	£26.80	340	MDM807T	£7.40	338	MDR908S	£23.50	375	MDV844N	£13.50	420
MD953N	£15.00	340	MDM808	£7.70	336	MDR915	£30.00	375	MDV844NF	£13.30	421
MD954N	£18.30	340	MDM808T	£7.40	338	MDR908	£32.90	376	MDV846N	£17.80	420
MD960N	£6.50	340	MDM809	£7.70	336	MDRT908	£64.70	375	MDV860N	£9.30	421
MD961N	£8.40	340	MDM809T	£7.40	338	MD-SCR	£20.60	460	MDV862N	£10.20	421
MD961N1	£10.60	340	MDM810	£7.70	336	MDT932N	£12.10	342	MDV864N	£13.40	421
MD961N2	£8.20	340	MDM810T	£7.40	338	MDT934N	£17.00	342	MDV864NF	£12.80	421
MD962N	£10.70	340	MDM815	£7.70	336	MDT935N	£19.30	342	MDV866N	£18.90	421
MD962N1	£11.20	340	MDM815T	£7.40	338	MDT952N	£12.20	342	MDV906N	£54.50	423
MD962N2	£10.80	340	MDMC715N	£7.20	338	MDT953N	£17.00	342	MDV909N	£65.90	423
MD962N3	£8.00	340	MDN505	£15.40	343	MDTHQ	£23.30	374	MDV9855	£9.40	480
MD962N4	£10.60	340	MDN5055	£15.50	343	MDV700	£11.30	422	MH75	£14.50	488
MD962N4A	£11.50	340	MDN506	£15.60	343	MDV710	£10.70	422	MH90	£23.40	488
MD962N5	£10.70	340	MDN507	£15.80	343	MDV724N	£10.80	420	MIR25	£52.40	450
MD963N	£15.10	340	MDN508	£16.40	343	MDV726N	£12.10	420	MKV709	£19.90	427
MD964N	£18.60	340	MDN510	£16.70	343	MDV731	£5.30	422	MKV709A	£27.50	427
MDA180	£6.60	460	MDN511	£17.30	343	MDV732	£6.40	422	MP1400	£628.00	308
MDA-R	£9.70	460	MDN512	£18.10	343	MDV733	£7.30	422	MP2700	£727.00	308
MDBH	£11.60	373	MDN513	£18.50	343	MDV734	£7.70	422	MP91500	£709.00	309
MDH-L	£9.80	460	MDNT405	£16.20	343	MDV742N	£10.60	420	MPSL01	£58.00	308
MDH-S	£10.10	460	MDNT4055	£16.20	343	MDV744N	£13.40	420	MPSL02	£81.00	308
MDM700	£11.00	337	MDNT406	£16.20	343	MDV751	£6.50	422	MPV600507	£22.50	428
MDM706	£30.30	337	MDNT409	£18.90	343	MDV752	£7.70	422	MPV600508	£23.00	428
MDM706TX	£30.90	338	MDNT411	£20.60	343	MDV762N	£10.70	421	MPV600509	£23.00	428
MDM706TXT	£32.50	338	MDNT412	£21.50	343	MDV764N	£13.50	421	MPV600510	£23.70	428
MDM711	£6.40	336	MDNT413	£22.00	343	MDV771	£6.50	422	MPV600511	£25.60	428
MDM712	£6.40	336	MDNT414	£23.70	343	MDV772	£7.70	422	MPV600512	£25.60	428
MDM713	£6.40	336	MDP125	£6.60	461	MDV802N	£12.60	421	MPV600513	£26.90	428
MDM714	£6.40	336	MDP35	£6.60	461	MDV820N	£8.10	420	MPV600514	£26.90	428
MDM715	£6.40	336	MDP90	£6.60	460	MDV822N	£8.10	420	MPV600515	£29.30	428
MDM716	£6.40	336	MDQ147	£17.60	374	MDV823N	£8.50	420	MPV600516	£29.30	428
MDM717	£6.40	336	MDQ183	£18.90	374	MDV824N	£10.10	420	MPV600517	£29.30	428
MDM718	£6.40	336	MDQ217	£19.40	374	MDV826N	£11.10	420	MPV600518	£33.80	428





		PAGE			PAGE			PAGE			PAGE
MPV600519	£33.80	428	NS45506M	£9.00	365	PGW1719	£54.50	329	PP05	£8.90	493
MPV600520	£41.90	428	NS45507M	£9.50	365	PGW1922	£54.50	329	PP06	£8.90	493
MPV600521	£41.90	428	NS45508M	£9.50	365	PGW1924	£54.70	329	PP07	£11.20	493
MPV600522	£41.90	428	NS45508R	£9.50	365	PGW2124	£61.70	329	PP08	£11.20	493
MPV600523	£44.80	428	NSP65108	£7.80	365	PGW2430	£88.90	329	PPS06	£45.70	494
MPV600524	£44.80	428	NSP65507	£8.80	365	PGW2730	£93.90	329	P-SG01	£27.60	497
MR500	£11.70	343	NSP65508	£7.70	365	PH2500103	£5.20	351	P-SG02	£27.60	497
MRP06	£10.40	461	NSP65510	£8.00	365	PH2500110	£10.10	351	P-SG03	£30.90	497
MRP95	£15.80	461	NSP65513	£8.90	365	PH2500203	£5.20	351	PT3810R	£26.20	256
MT03	£9.30	452	O9100115	£18.80	284	PH2500210	£10.10	351	P-UKF	£14.20	443
MT03MM	£9.30	452	O910075	£16.50	284	PH2500303	£5.20	351	PWC12	£51.00	332,416
MT05	£14.10	452	O92194	£3.10	284	PH2500310	£10.10	351	PWC14	£64.00	332,416
MT05MM	£14.10	452	O92244	£3.50	284	PH5000103	£6.90	352	PWC18	£88.00	332,416
MT08	£27.30	452	O95034	£5.00	284	PH5000203	£6.90	352	PWC24	£136.00	332,416
MT08MM	£27.30	452	O95036	£5.00	284	PH5000303	£6.90	352	PWC36	£280.00	332,416
MV3800	£104.90	426	O95046	£5.00	284	PH7000102	£6.90	352	PZ2500103	£5.00	355
MV380020	£25.50	426	O97043	£5.00	284	PH7000202	£6.90	352	PZ2500110	£9.60	355
MV380021	£32.30	426	O97045	£5.00	284	PH8900101	£7.20	352	PZ2500203	£5.00	355
MV380506	£17.40	427	O97051	£5.00	284	PH8900201	£7.20	352	PZ2500210	£9.60	355
MV380507	£17.40	427	P90433	£5.00	284	PHF0365	£9.90	342	PZ2500303	£5.00	355
MV380508	£17.40	427	P90435	£5.00	284	PHH0102	£9.90	342	PZ2500310	£9.60	355
MV380509	£17.40	427	P90445	£5.00	284	PHH32000305	£7.70	351	PZ5000103	£7.00	355
MV380510	£17.40	427	P90543	£5.30	284	PHH32010205	£7.70	351	PZ5000203	£7.00	355
MV380511	£17.40	427	P90545	£5.30	284	PHP3000101	£3.30	353	PZ5000303	£7.00	355
MV380512	£17.40	427	P90551	£5.30	284	PHP3000105	£11.10	353	PZ7000102	£7.00	355
MV380513	£17.40	427	P906110	£13.20	284	PHP3000201	£3.30	353	PZ7000202	£7.00	355
MV380514	£18.00	427	P90675	£13.20	284	PHP3000205	£11.10	353	PZ8900101	£7.30	356
MV380515	£18.90	427	P92320	£3.20	284	PHP3000301	£3.30	353	PZ8900201	£7.30	356
MV380516	£18.90	427	P92325	£3.70	284	PHP3000305	£11.10	353	PZP3000101	£3.30	356
MV380517	£18.90	427	PBI2	£24.10	477	PHP5000101	£3.70	353	PZP3000105	£11.10	356
MV380518	£18.90	427	PBI2A	£20.70	477	PHP5000201	£3.70	353	PZP3000201	£3.30	356
MV380519	£18.90	427	PB16	£32.40	477	PHP5000301	£3.70	353	PZP3000205	£11.10	356
MV380520	£20.10	427	PB18A	£32.00	477	PHP8900201	£7.10	353	PZP3000301	£3.30	356
MX04	£101.90	260	PB20	£51.70	477	PM14	£18.40	252	PZP3000305	£11.10	356
NS02	£38.70	475	PB22A	£34.00	477	PP03	£8.90	493	PZP5000101	£3.90	356
NS45108M	£9.00	365	PCX05	£46.10	494	PP04	£8.90	493	PZP5000201	£3.90	356





INDEX

		PAGE			PAGE			PAGE			PAGE
PZP5000301	£3.90	356	SE05	£24.20	475	SP31810Q	£251.00	473	ST38311	£32.80	476
PZP8900201	£7.10	356	SE141	£3.80	474	SP32215	£315.00	473	ST38312	£33.50	476
PZZ0102	£9.90	342	SE142	£3.80	474	SP32215Q	£338.00	473	ST38313	£35.10	476
PZZ32000305	£7.70	354	SE143	£3.80	474	SP32615	£324.00	473	ST38314	£35.60	476
PZZ32010205	£7.90	354	SEL01S	£4.60	474	SP32615Q	£424.00	473	ST38316	£36.20	476
QC114	£13.00	366	SEL02S	£5.00	474	SP3320	£439.00	473	ST38317	£36.70	476
RHA14	£20.80	252	SEL03S	£6.90	474	SP3320Q	£428.00	473	STMM1150	£5.70	451
ROB2500103	£5.60	363	SEL04S	£8.00	474	SP33320	£478.00	473	TI220AF	£207.00	234
ROB2500203	£5.60	363	SEL05S	£8.90	474	SP33320Q	£526.00	473	TI221	£198.00	234
ROB2500303	£5.60	363	SG713	£13.10	496	SPBP20	£23.80	463	TI221-6	£198.00	235
ROBP3000101	£3.30	364	SG713G	£17.40	496	SQAA200	£37.60	454	TI234	£315.00	235
ROBP3000105	£11.00	364	SG960	£9.10	496	SQAA250	£39.90	454	TI244	£391.00	236
ROBP3000201	£3.30	364	SG960A	£8.10	496	SQAA300	£45.00	454	TI268	£509.00	236
ROBP3000205	£11.00	364	SG960G	£9.20	496	SQAB10070	£22.60	455	TI408	£60.10	223
ROBP5000101	£3.80	364	SG960Y	£9.20	496	SQAB150100	£32.00	455	TI422	£89.70	223
ROBP5000201	£3.80	364	SLO2	£80.50	468	SQAB200130	£46.80	455	TI423	£84.60	224
ROBP5000301	£3.80	364	SLO3	£121.30	468	SQAB300175	£92.20	455	TI424	£68.30	224
ROBP8900101	£7.10	364	SLM0300	£86.80	453	SQAC300	£153.90	455	TI435AF	£97.90	225
ROBP8900201	£7.10	364	SLM0400	£87.10	453	SR2180	£50.30	435	TI436	£90.90	225
ROBP8900301	£7.10	364	SLM0600	£98.60	453	SSH02	£30.70	494	TI460	£204.90	226
SC01	£1,216.00	45	SLM1000	£118.90	453	ST12319	£51.40	476	T3418-6	£615.00	239
SC02	£1,419.00	45	SLM1200	£153.80	453	ST12321	£54.50	476	T3834	£97.90	228
SC03	£1,196.00	46	SLT01	£38.60	453	ST12322	£56.50	476	T3835AF	£178.50	228
SC04	£1,206.00	46	SP11	£120.40	472	ST12324	£57.00	476	T3839	£158.90	229
SC04E	£1,206.00	47	SP1410	£127.40	473	ST12325	£59.60	476	T3840	£214.90	229
SCE1	£1,199.00	121	SP1410Q	£164.40	473	ST12506-C	£18.90	476	T3848	£505.00	230
SCE2	£1,219.00	122	SP1810	£134.60	473	ST12508-C	£19.70	476	T3867	£434.00	230
SCE3	£1,819.00	122	SP1810Q	£178.00	473	ST12510-C	£22.10	476	T9206	£82.90	245
SCE4	£1,299.00	123	SP22	£232.00	472	ST12512-C	£23.50	476	T9218AF	£183.90	245
SCE5	£1,899.00	123	SP2215	£220.00	473	ST200	£11.10	451	T9218LAF	£265.90	245
SCP01	£27.80	493	SP2215Q	£263.00	473	ST38112	£30.00	476	T9222	£210.90	245
SCPS01	£148.90	58	SP2615	£245.00	473	ST38116	£35.10	476	T9222L	£346.90	246
SCPS01E	£147.90	59	SP2615Q	£298.00	473	ST38122	£36.80	476	T9240	£540.90	246
SCR01	£20.10	484	SP31410	£203.00	473	ST38306	£29.90	476	T9417	£439.90	246
SCR02	£6.50	484	SP31410Q	£241.00	473	ST38308	£29.90	476	T9417L	£639.90	247
SD501	£12.40	486	SP31810	£218.00	473	ST38310	£31.10	476	T9421LAF	£754.90	247





		PAGE			PAGE			PAGE			PAGE
T9423AF	£608.90	247	TCA08	£18.20	209	TCP445C	£66.90	204	TC-UPRRS	£62.80	216
TAP-HNDL	£15.90	441	TCATP	£73.60	209	TC-PA01	£96.90	216	TCW707EV	£999.00	201
TBSKT07	£24.40	270	TCATV	£117.90	209	TC-PA02	£175.90	216	TCW907X	£1,499.00	202
TBSKT08	£24.50	270	TCAV4	£325.90	490	TC-PA03	£133.50	216	TC-WC02	£44.50	205
TBSKT10	£24.50	270	TCB180	£2,009.00	219	TCPRK	£19.90	211	TCW-HK02	£23.10	213
TBSKT12	£25.20	270	TCB80	£571.00	219	TC-S01	£549.00	216	TCW-HK03	£40.90	213
TBSKT13	£25.80	270	TCC02	£56.50	214	TC-S02	£497.00	216	TCW-HK10	£22.30	213
TBSKT14	£26.20	270	TCC03	£65.50	214	TC-S03	£439.90	217	TCW-HK45	£22.80	213
TBSKT17	£29.30	270	TCCH	£10.10	210	TC-S03AL	£649.00	217	TCW-HK90	£22.40	213
TBSKT19	£29.30	270	TC-COVER	£24.90	205	TC-S03AR	£649.00	217	TCW-SP	£118.90	213
TBUSP14	£42.80	463	TC-COVER1	£62.40	206	TC-S04	£319.00	217	TCW-SP01	£121.90	212
TBUSP16	£42.90	463	TCCTH	£43.90	210	TCSB	£153.50	204	TDD03050	£11.50	440
TBUSP21	£44.50	463	TCDIVL	£13.50	206	TCSB16	£168.90	205	TDD04070	£11.50	440
TC-160UR	£219.90	216	TCDIVS	£13.50	206	TC-SC	£445.90	203	TDD05080	£11.50	440
TC-180KEY-LOCK	£22.60	211	TCDRK	£17.70	211	TC-SL01	£549.00	216	TDD06100	£11.50	440
TC-180LOCK	£29.30	211	TCF01	£13.10	207	TC-SL02	£789.00	216	TDD08125	£11.50	440
TC187	£514.90	177	TCF03	£59.90	207	TC-SL03AL	£984.00	217	TDD10150	£11.50	440
TC450	£145.90	204	TCF04	£38.70	207	TC-SL03AR	£984.00	217	TDD12175	£11.50	440
TC540	£195.90	205	TCF05	£29.50	207	TCSMC	£101.90	218	TDT03050	£8.00	440
TC-6T	£105.90	203	TCF06	£31.50	207	TCT01	£55.90	214	TDT04070	£8.00	440
TC-6T01	£637.90	47	TCF07	£37.90	207	TCT02	£59.90	214	TDT05080	£8.10	440
TC-6T02	£832.90	48	TC-FB01	£19.20	216	TCT03	£71.30	214	TDT06100	£8.10	440
TC-6TE01	£679.90	124	TC-FB02	£29.70	216	TCT04	£47.20	214	TDT08125	£8.30	440
TC-6TE02	£596.90	124	TC-FB03	£22.50	216	TC-TB01	£329.00	215	TDT10150	£8.70	440
TC-6TE03	£914.00	125	TC-H01	£29.80	216	TC-TB02	£177.00	215	TDT12175	£8.70	440
TC-6TE04	£927.00	125	TC-H02	£42.60	216	TC-TB03	£199.00	215	TEA01	£24.30	130
TC-6TE05	£893.00	126	TC-H05	£36.00	216	TC-TB05	£135.00	215	TEA02	£24.30	131
TC-6TE06	£969.00	126	TC-LBK	£52.50	216	TC-TB06	£263.00	215	TEA1487	£162.90	139
TC803SV	£329.00	201	TC-LEG	£110.90	216	TC-TB07	£310.00	215	TEA9214LAF	£154.90	148
TC804EV	£449.00	200	TC-LOCK3	£39.80	212	TC-TB08	£94.90	215	TEA9216AF	£134.20	148
TC805SV	£867.00	200	TC-LOCK5	£54.00	212	TC-TBS02	£224.90	215	TEABS50	£104.90	161
TC-90CLOCK	£29.30	211	TC-MAG	£41.50	211	TC-TBS04	£305.90	215	TEAHR81	£123.90	172
TC-90KEY-LOCK	£22.60	211	TC-MAG1	£24.90	210	TCTMC	£112.50	218	TEAMD04N	£46.50	156
TCA01	£127.90	209	TC-MAT	£22.90	206	TC-UPRL	£72.90	216	TEAMD04N1	£47.50	156
TCA06	£179.90	495	TCMME179	£2,099.00	120	TC-UPRLS	£62.80	216	TEAMD04TXN	£51.90	156
TCA07	£212.90	495	TCMME217K	£2,375.00	120	TC-UPRR	£72.90	216	TEAMDQ78	£113.90	161

INDEX

		PAGE			PAGE			PAGE			PAGE
TEAMDVO4N	£48.70	165	TEFMBP7	£267.90	132	TEXRL03	£152.90	138	TJNS05	£48.80	52,371
TEAMDVO4NI	£55.20	166	TEFMBP7E	£266.90	132	TEXTB05	£153.90	171	TJSE05S	£30.20	54,475
TEAMDVI0	£71.20	165	TEFMBV07	£304.90	168	TEXW05	£155.90	171	TKP26R16	£729.00	177
TEASD38	£164.90	151	TEFMD54	£212.90	159	TEZ01	£21.90	132	TKS26B1033T	£8,999.00	29
TEASR04A	£56.60	172	TEFMDI54	£223.90	160	TEZMD06	£60.50	157	TKS26R1033T	£8,999.00	27
TEAVSD09	£211.90	151	TEFMDV12	£149.90	166	TEZSD02	£242.90	151	TKS26R1034T	£9,149.00	31
TED00	£42.20	131	TEFMDV15	£154.90	167	TEZSN06	£138.90	172	TKS26R418F	£5,199.00	109
TED01	£42.20	131	TEFSK44	£383.90	141	TEZVG03	£71.90	165	TKS26R528F	£9,311.00	111
TED1227	£224.50	141	TEFSK57	£367.90	142	TF22	£17.80	477	TKS26R702F	£7,899.00	113
TED1489	£199.90	139	TEFSKV19	£513.90	170	TF2230RK	£8.30	477	TKS26R753T	£6,799.00	33
TED3836	£195.90	140	TEFSPV17	£545.90	170	TF30	£31.70	477	TKS53R1133F	£17,649.00	107
TED441Q	£208.90	163	TEFX06	£187.90	133	TF300	£132.50	478	TKS53R1295T	£15,799.00	25
TED441-TQ	£224.90	163	TEFX06E	£187.90	133	TF300RK	£88.90	478	TKT26R137T	£1,529.00	44
TED6512R	£359.90	153	TEFX07	£304.90	133	TFA0252RK	£29.90	479	TKW26R278F	£3,769.00	119
TED6515	£163.90	152	TEFXV11	£256.90	167	TFA10	£32.90	479	TKW26R335F	£4,699.00	118
TED8012	£174.90	152	TEFXV17	£302.90	168	TFA12	£33.80	479	TKW26R516T	£3,629.00	42
TED909TXN	£114.90	157	TEFXV27	£643.90	169	TFA15	£35.70	479	TKW26R628T	£4,019.00	43
TED911N	£121.90	156	TEFXV28	£503.90	169	TFA22	£41.00	479	TKW37B1008T	£8,499.00	37
TED9121	£269.90	148	TEP65508	£12.10	474	TFP01	£94.30	478	TKW37R513F	£7,999.00	117
TEDADJ4	£176.90	155	TEP65510	£12.90	474	TFP01RK	£29.20	478	TKW37R595T	£7,249.00	41
TEDBS47	£220.90	140	TEP65511	£13.70	474	TGMMUNC	£23.20	451	TKW37R637F	£5,999.00	115
TEDCT06	£196.90	170	TEP65512	£13.70	474	THBS22	£28.50	369	TKW37R663T	£5,899.00	39
TEDDF7	£212.90	155	TEP65513	£14.90	474	T-HD	£9.10	261	TKW53R615T	£7,799.00	35
TEDHEX7	£98.90	162	TEX02	£34.50	131	T-HD01	£8.00	261	TM080	£630.90	244
TEDHT42	£161.90	162	TEX1238	£249.90	152	THDV105	£892.00	176	TM095	£411.00	240
TEDIMM	£255.90	171	TEX2032	£174.90	152	THDV105E	£892.00	176	TM106	£599.00	241
TEDLBS17	£172.90	141	TEX3403	£314.90	143	TJ028	£47.20	53,369	TM111	£591.00	242
TEDPC14	£223.90	172	TEX3410	£217.90	143	TJ1412	£36.90	130,371	TM127	£469.00	243
TEDSD14	£283.90	150	TEX6308	£179.90	153	TJ1413	£36.90	130,371	TM708	£43.70	337
TEDTX7	£96.50	162	TEX915N	£101.90	157	TJ1414	£35.20	130,371	TORQ02U	£1,539.00	309
TEDV3818	£408.90	169	TEXBR03	£149.90	138	TJ1419	£62.80	54,222	TORQ03U	£1,539.00	309
TEDV440	£174.90	168	TEXEXT13	£167.90	142	TJ1420	£65.20	54,223	TORQ04U	£1,549.00	309
TEDV909N	£108.90	166	TEXFLS06	£293.90	153	TJ1429	£66.50	52,370	TORQ05U	£1,649.00	309
TEDVMB08	£205.90	168	TEXMDTN	£91.90	160	TJ1430	£67.50	52,370	TORQS01	£342.00	309
TEDVSP12	£344.90	170	TEXPB4	£169.90	171	TJ149	£25.50	53	TORQU	£3,159.00	309
TEFMB7	£260.90	132	TEXRF03	£172.90	138	TJEP05	£59.10	53	TPM01	£607.00	218

		PAGE			PAGE			PAGE			PAGE
TPM02	£759.00	218	TSW53R9	£3,349.00	196	TT6511R	£299.90	78	TTDTD34	£285.50	96
TPX2501003	£6.00	361	TSW64R15	£5,914.00	197	TT8012	£135.90	76	TTDV910N	£93.90	94
TPX2501503	£6.00	361	TT00	£18.30	55	TT804	£89.90	100	TTEAF62	£509.90	155
TPX2502003	£6.00	361	TT01	£18.30	55	TT9015HX	£233.90	73	TTEISK103	£879.90	149
TPX2502503	£6.00	361	TT02	£18.30	55	TT9024	£112.90	70	TTEISK33	£1,029.90	150
TPX2502703	£6.00	361	TT03	£18.30	56	TT905N	£42.70	82	TTEISK73	£863.90	149
TPX2503003	£6.00	361	TT04	£18.30	56	TT9116N	£137.90	72	TTEMB11	£353.90	163
TPX2504003	£6.00	361	TT1205	£116.20	65	TT9120DN	£174.90	72	TTEMB13Q	£461.90	164
TQAG	£82.90	308	TT1211	£113.20	65	TT917N	£63.50	82	TTEMB14Q	£509.90	164
TRC1012	£17.50	463	TT1215AF	£85.20	66	TT917TXN	£64.50	83	TTEMD114	£372.30	159
TRC1418	£15.10	463	TT1217	£85.60	65	TT9207	£117.90	71	TTEMD115N	£360.90	137
TSC15R1	£723.90	202	TT1217-6	£85.60	65	TT9207A	£117.90	71	TTEMD122N	£519.90	158
TSC15RID	£571.90	203	TT1218	£142.70	66	TT9212	£161.90	72	TTEMD33	£286.90	157
TSC15R7	£967.90	202	TT1218-6	£142.70	66	TT9212TX	£205.90	72	TTEMD98N	£389.90	158
TSC8RID	£188.90	203	TT1236	£92.90	77	TTADJ04	£147.90	81	TTEPS12	£349.90	134
TSM26B3	£389.90	190	TT1435	£107.90	60	TTADP17	£113.90	70	TTEPS15	£399.90	134
TSM26R3	£389.90	190	TT1435I2	£107.90	61	TTAF32	£98.90	61	TTEPS25	£349.90	135
TSS26B16	£2,276.00	198	TT1448	£101.90	62	TTAF32I2	£99.90	62	TTESK126	£513.90	145
TSS26R16	£2,276.00	198	TT3592	£85.50	77	TTALU	£27.90	55	TTESK25	£872.90	144
TSS37R12	£3,164.00	199	TT3816	£80.50	63	TTBE18	£555.90	101	TTESK32	£814.90	144
TSS53R19	£5,615.00	199	TT3816I2	£80.50	63	TTBM	£114.50	97	TTESK63	£724.90	143
TST11R2	£165.90	187	TT3819	£124.90	63	TTBS35	£80.90	64	TTESK67	£545.90	146
TST26B4	£577.90	188	TT3819I2	£124.90	63	TTBS53	£139.90	88	TTESK73	£589.00	147
TST26B4P	£577.90	189	TT440	£116.90	90	TTCP04	£147.90	102	TTESK77	£629.90	146
TST26R4	£577.90	188	TT440Q	£122.50	90	TTCP12I	£53.90	101	TTESK85	£554.90	147
TST26R5F	£961.90	189	TT440-T	£124.90	90	TTD00	£28.90	56	TTESK86	£627.90	145
TST37R5F	£1,589.00	191	TT440-TQ	£133.50	91	TTD01	£28.90	56	TTESP15	£226.00	154
TST53R10F	£2,549.00	191	TT474-5E	£108.90	92	TTD02	£28.90	57	TTESP28	£294.90	137
TSW26B9	£1,429.00	194	TT474-7E	£114.90	92	TTD441Q	£256.90	91	TTESP31	£641.90	154
TSW26R4L	£1,020.00	192	TT6010M	£102.90	77	TTD912TXN	£117.90	83	TTESP31A	£649.90	154
TSW26R6	£1,234.00	193	TT6010MRS	£221.90	79	TTD914N	£119.90	83	TTESP37	£1,009.00	153
TSW26R6L	£1,084.00	192	TT6208	£65.90	80	TTD9416	£251.90	73	TTEVG11	£383.90	165
TSW26R7	£1,229.00	193	TT6506	£168.90	81	TTDB28	£137.50	96	TTEX15	£281.00	133
TSW26R9	£1,429.00	194	TT6508R	£224.90	78	TTDCM	£199.90	98	TTEX17	£442.90	136
TSW37B8	£1,834.00	195	TT6508RAF	£249.90	79	TTDCT05	£169.90	95	TTEX18	£382.90	135
TSW37R7	£1,729.00	195	TT6508RF	£262.90	79	TTDCT06	£181.50	95	TTEX219	£942.90	136

INDEX

		PAGE			PAGE			PAGE			PAGE
TTEX23N	£362.90	163	TTNF12-10	£5.60	446	TTVG05	£102.90	92	TV18N	£429.90	426
TTEX32	£540.90	154	TTNF12-11	£5.60	446	TTVSD09	£199.90	94	TWB1500	£729.00	219
TTHC03	£54.90	99	TTNF12-12	£5.60	446	TTX00	£17.70	57	TWB-15SQ	£33.90	219
TTHEX16	£116.90	66	TTNR81	£212.90	102	TTX01	£20.90	57	TWB-15TOP	£508.90	219
TTHEX23	£87.90	67	TTOS16	£124.50	99	TTX02	£20.90	57	TWB2000	£911.00	219
TTHEX7	£68.50	88	TTPC09	£86.90	103	TTX03	£20.40	58	TWB-20SQ	£38.50	219
TTHEX7AF	£68.50	89	TTPS09	£228.90	58	TTX2032	£156.90	77	TWB-20TOP	£662.00	219
TTHEX7S	£68.50	88	TTPS09E	£225.90	59	TTX2436	£216.50	78	TWB-4WD	£132.50	219
TTHP08	£184.90	81	TTPSAD	£224.90	100	TTX2493	£159.90	76	TWB-FB	£31.90	219
TTHR81	£113.90	102	TTPSPG	£119.90	93	TTX2640	£156.90	78	TWB-LEG	£316.00	219
TTHT28	£92.50	89	TTRORS	£122.90	81	TTX3402E	£329.90	69	TWB-PA	£115.90	219
TTID19	£61.20	74	TTRS15	£124.90	68	TTX3404	£312.90	69	TWB-UPR	£53.20	219
TTID20	£56.90	74	TTRSD15	£79.50	82	TTX3414	£210.90	69	TX2500603	£5.50	357
TTK40	£93.50	95	TTRSD15-141	£13.70	367	TTX344F	£216.90	69	TX2500703	£5.50	357
TTLA03	£184.00	103	TTRSD15-238	£17.20	367	TTX3892	£241.90	76	TX2500803	£5.50	357
TTMB03	£86.60	90	TTSD38	£151.90	75	TTX474-9E	£184.90	92	TX2500903	£5.50	357
TTMD12D	£67.90	84	TTSN11	£124.90	100	TTX6311	£189.90	79	TX2501003	£5.50	357
TTMD74	£76.50	86	TTSR04	£54.30	98	TTX6607	£129.90	80	TX2501503	£5.50	357
TTMD74-1	£2.70	366	TTSR04A	£49.90	98	TTX6707	£177.90	80	TX2502003	£5.50	357
TTMD74-2	£4.30	366	TTSS07	£165.90	99	TTX918N	£94.90	83	TX2502503	£5.50	357
TTMDP	£33.90	98	TTTC06	£154.90	102	TTX9415	£398.90	73	TX2502703	£5.50	357
TTMDQ38	£79.50	86	TTTD17	£104.50	96	TTXBR03	£146.90	59	TX2503003	£5.50	357
TTMDQ49	£102.90	85	TTTTF10	£119.90	100	TTXEXT13	£149.90	68	TX2504003	£5.50	357
TTMDR84	£96.50	85	TTTJ04	£16.20	54	TTXF05	£92.90	97	TX5000803	£6.90	358
TTMDRT64	£99.90	87	TTTM03	£83.20	103	TTXFLS06	£291.90	80	TX5001003	£6.90	358
TTMI16	£141.90	84	TTTS08	£170.90	73	TTXMD41N	£91.50	87	TX5001503	£6.90	358
TTNF12	£55.50	97	TTTX18	£120.50	67	TTXMDTN	£76.90	84	TX5002003	£6.90	358
TTNF12-01	£5.60	445	TTTX23	£87.90	67	TTXND	£146.90	89	TX5002503	£6.90	358
TTNF12-02	£5.60	445	TTTX30	£123.50	64	TTXPI292	£211.90	76	TX5002703	£6.90	358
TTNF12-03	£5.60	445	TTTX7	£65.50	89	TTXPB3	£102.50	101	TX5003003	£6.90	358
TTNF12-04	£5.60	445	TTTXH15	£118.90	67	TTXPB3A	£83.50	101	TX7001002	£6.90	358
TTNF12-05	£5.60	445	TTV3814	£332.90	95	TTXRF03	£163.90	60	TX7001502	£6.90	358
TTNF12-06	£5.60	445	TTV440	£143.90	94	TTXRL03	£141.90	59	TX7002002	£6.90	358
TTNF12-07	£5.60	446	TTV706N	£60.50	93	TTXTB09	£174.90	99	TX7002502	£6.90	358
TTNF12-08	£5.60	446	TTV710N	£62.50	94	TTZ01	£18.50	58	TX8901001	£7.10	358
TTNF12-09	£5.60	446	TTV907N	£59.90	93	TTZVC03	£61.90	93	TX8902001	£7.10	358

		PAGE
TX8902501	£7.10	358
TX8903001	£7.10	358
TXP3001001	£3.60	359
TXP3001005	£11.10	359
TXP3001501	£3.60	359
TXP3001505	£11.10	359
TXP3002001	£3.60	359
TXP3002005	£11.10	359
TXP3002501	£3.60	359
TXP3002505	£11.10	359
TXP3002701	£3.60	359
TXP3002705	£11.10	359
TXP3003001	£3.60	359
TXP3003005	£11.10	359
TXP3004001	£3.60	359
TXP3004005	£11.10	359
TXP5001001	£4.00	359
TXP5001501	£4.00	359
TXP5002001	£4.00	359
TXP5002501	£4.00	359
TXP5002701	£4.00	359
TXP5003001	£4.00	359
TXP5004001	£4.00	359
TXP8902001	£7.60	359
TXP8902501	£7.60	359
TXP8903001	£7.60	359
TXX1015	£9.90	342
TXX2025	£9.90	342
TXX3040	£9.90	342
TXX32101505	£8.10	357
TXX32202505	£8.10	357
WRDF06	£174.50	178
WRFL05	£80.50	178
WRMDT05N	£82.20	179
WRSP12	£107.90	178
WRTX07	£74.50	179



TENGTTOOLS®

SERVICE CHARGES

All our products are covered by warranties and guarantees that cover faulty workmanship or faulty material but we also have products with moving parts that after time need repair or servicing. Often the end user is able and willing to service the tool or machine themselves and to help with this we have produced a spare parts manual for tools and machines where it is possible to replace worn or damaged parts. A copy of this or replacement copies of manuals for other tools and machines are all available on request. When the end user cannot or will not service the tool or machine themselves TengTools can offer a full repair and servicing facility which is chargeable at a price that is designed to cover our costs only. We can offer this service via stockists and will not normally deal direct with the end user

Servicing and recalibration of torque wrenches is available on request from your local TengTools stockist. There is a cost for this service unless the fault is covered by warranty. Servicing and repair of ratchets is also available on request at a cost, unless the fault is covered by warranty. Servicing and repair of air tools is offered through your local TengTools stockist and a cost will be determined upon request, unless the fault is covered by warranty. If we believe the repair to be uneconomic we will of course contact you before starting any work that would incur charges. All TengTools hex drive bits are designed and manufactured to the latest industry standards. However, screwdriver and socket bits are classified as consumables and as such are only guaranteed for conformity to dimensional standards.

SUMMARY OF TERMS & CONDITIONS OF SALE

All orders are accepted by Teng Tools UK and their stockists subject to their Terms and Conditions of Sale. Teng Tools UK only distribute through their approved stockists and do not supply goods directly to the end user. If you are a stockist or potential stockist then a complete copy of the Teng Tools UK terms of trade is available on request. If you are an end user wishing to purchase any of the goods in this catalogue then details of your local stockist can easily be found at www.tengtools.com or you can contact Teng Tools UK through the web site "Contact us" area. All descriptions of the products and services contained within catalogues, promotional literature and the Teng Tools web site, or otherwise communicated, to the Customer are approximate only, and shall not form any part of the contract between Teng Tools UK and the Customer. The prices shown in this Product Guide correspond to those on the web site but are for guidance only. All prices exclude VAT which will be charged at the rate applicable at the date of despatch. Whilst Teng Tools UK will try to maintain the prices quoted in this catalogue and on its web site, Teng Tools UK reserves the right to change them without prior notice at any time before despatch. Teng Tools UK executes orders to the Customer's requirements, but reserves the right to substitute one product for another where the product has been superseded or where the product is the same brand and the product technical function, performance and quality can be seen as equivalent. To the extent that orders cannot be fulfilled completely from stock, the unfulfilled balance will be noted and then charged at a price that is valid at the date of order. Alternatively, if so requested, where orders cannot be fulfilled completely from stock, the unfulfilled balance will be considered cancelled. Unless otherwise stated, electrical ratings represent safe working limits. Dimensions and other physical characteristics are subject to normal commercial tolerances. Teng Tools UK reserves the right, without prior notice, to discontinue any product or to make design changes as part of its continuous programme of product improvement, or to assist product availability. Where possible, future design changes will be indicated against the description in the Teng Tools web site. Teng Tools UK recommends that the Customer verify dimensions and other data published in the web site together with future availability, before incorporating products into designs or for other critical purposes. The information contained in this catalogue was, so far as Teng Tools UK was aware, correct at the time of going to press and Teng Tools UK do not accept responsibility for any errors. The Customer shall ensure that all warnings, labels, instructions, manuals and other information in respect of the products or their use which are supplied with the products are not lost or damaged in any way whilst the products are in its possession or under its control and that they are supplied with the products when it releases them from its possession or control. Teng Tools UK warrants that if defects appear in products due to faulty workmanship or materials, under proper use, it will replace or repair the product. If not explicitly expressed in a Teng Tools UK catalogue, this warranty is subject to a claim being made to Teng Tools UK within 12 months of the sale to the final consumer. This warranty is also subject to the products or parts to which the claim relates being returned to Teng Tools UK within that period suitably packaged, carriage paid and, where relevant, in accordance with any particular instructions which Teng Tools UK may have notified to the Customer at the time of supply. Teng Tools UK shall not be under any liability for damage, loss or expenses resulting from the failure to give advice or information or the giving of incorrect advice or information whether or not due to its negligence or that of its employees, agents or sub-contractors. Teng Tools UK liability (if any) to the Customer for a breach of any express or implied terms of the contract between it and the Customer, or any order accepted by Teng Tools UK, or any other duty of any kind imposed on Teng Tools UK by law arising out of or in relation to the contract or order, or in respect of any defect in the products, shall be limited to the sum shown in the current full terms and conditions of sale. The Customer acknowledges that Teng Tools UK owns the copyright in this catalogue, and that its whole or partial reproduction without Teng Tools prior written consent is prohibited.